

UNIVERSAL
LIBRARY

OU_156465

UNIVERSAL
LIBRARY

OSMANIA UNIVERSITY LIBRARY

Call N

Accession No.

23176

Author

Lewis. Elisha S.

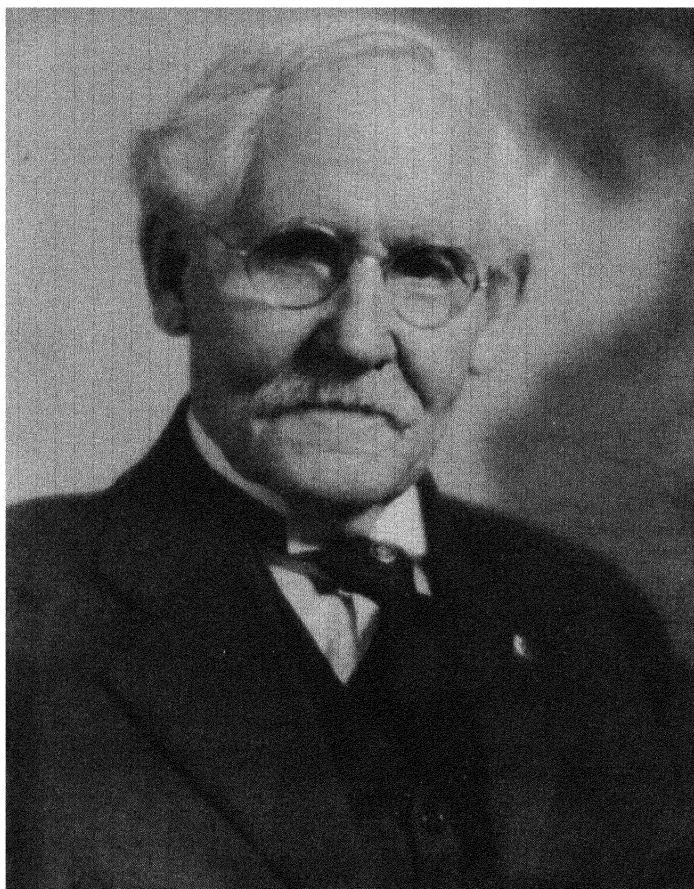
Title

Pythagorean propositions

This book should be returned on or before the date
last marked below.

1940

The Pythagorean Proposition



ELISHA S. LOOMIS

Photo 1935

The Pythagorean Proposition

Its Demonstrations Analyzed and Classified

And

Bibliography of Sources

FOR DATA of

The Four Kinds of "Proofs"

SECOND EDITION

1940

By

Elisha S. Loomis, Ph. D., LL. B.

Professor Emeritus of Mathematics

Baldwin-Wallace College

Professor Mathematics, Baldwin University, 1885-1895, Head
of Mathematics Department, West High School,
Cleveland, Ohio, 1895-1923

and

Author of "Original Investigation or How to
Attack an Exercise in Geometry"

(Ginn & Co., 1901)

Copyright, 1940, by
ELISHA S. LOOMIS
(Made and printed in the United States of America)

EDWARDS BROTHERS, INC.
LITHOPRINTERS
ANN ARBOR, MICHIGAN
1940

Dedicated

to

DR. OSCAR L. DUSTHEIMER, A.M., Ph.D.
Professor of Mathematics and Astronomy
Baldwin-Wallace College
Berea, Ohio

"In Mathematics the man who is ignorant of what Pythagoras said in Croton in 500 B.C. about the square on the longest side of a right-angled triangle, or who forgets what someone in Czechoslovakia proved last week about inequalities, is likely to be lost. The whole terrific mass of well-established Mathematics, from the ancient Babylonians to the modern Japanese, is as good today as it ever was."

E. T. Bell, Ph.D., 1931

FOREWORD

According to Hume, (England's thinker who interrupted Kant's "dogmatic slumbers"), arguments may be divided into: (a) demonstrations; (b) proofs; (c) probabilities.

By a demonstration, (demonstro, to cause to see), we mean a reasoning consisting of one or more catagorical propositions "by which some proposition brought into question is shown to be contained in some other proposition assumed, whose truth and certainty being evident and acknowledged, the proposition in question must also be admitted certain. The result is science, knowledge, certainty." The knowledge which demonstration gives is fixed and unalterable. It denotes necessary consequence, and is synonymous with proof from first principles.

By proof, (probo, to make credible, to demonstrate), we mean 'such an argument from experience as leaves no room for doubt or opposition'; that is, evidence confirmatory of a proposition, and adequate to establish it.

The object of this work is to present to the future investigator, simply and concisely, what is known relative to the so-called Pythagorean Proposition, (known as the 47th proposition of Euclid and as the "Carpenter's Theorem"), and to set forth certain established facts concerning the algebraic and geometric proofs and the geometric figures pertaining thereto.

It establishes that:

First, that there are but four kinds of demonstrations for the Pythagorean proposition, viz.:

I. Those based upon Linear Relations (implying the Time Concept)--the Algebraic Proofs.

II. Those based upon Comparison of Areas (implying the Space Concept)--the Geometric Proofs.

III. Those based upon Vector Operation (implying the Direction Concept)--the Quaternionic Proofs.

IV. Those based upon Mass and Velocity (implying the Force Concept)--the Dynamic Proofs.

Second, that the number of Algebraic proofs is limitless.

Third, that there are only ten types of geometric figures from which a Geometric Proof can be deduced.

This third fact is not mentioned nor implied by any work consulted by the author of this treatise, but which, once established, becomes the basis for the classification of all possible geometric proofs.

Fourth, that the number of geometric proofs is limitless.

Fifth, that no trigonometric proof is possible.

By consulting the Table of Contents any investigator can determine in what field his proof falls, and then, by reference to the text, he can find out wherein it differs from what has already been established.

With the hope that this simple exposition of this historically renowned and mathematically fundamental proposition, without which the science of Trigonometry and all that it implies would be impossible, may interest many minds and prove helpful and suggestive to the student, the teacher and the future original investigator, to each and to all who are seeking more light, the author, sends it forth.

CONTENTS

	Figures	Page
Foreword		vii
Portraits		xi
Acknowledgments		xiii
Abbreviations and Contractions		xv
The Pythagorean Proposition		3
Brief Biographical Information		7
Supplementary Historical Data		11
An Arithmetico-Algebraic Point of View		17
Rules for Finding Integral Values for a, b and h .		19
Methods of Proof--4 Methods		22
I. Algebraic Proofs Through Linear Relations . .		23
A. Similar Right Triangles--several thousand proofs possible	1- 35	23
B. The Mean Proportional Principle	36 53	51
C. Through the Use of the Circle	54- 85	60
(I) Through the Use of One Circle	54- 85	60
(1) The Method of Chords	54- 68	61
(2) The Method by Secants	69- 76	68
(3) The Method by Tangents	77- 85	74
(II) Through the Use of Two Circles	86- 87	80
D. Through the Ratio of Areas	88- 92	83
E. Through the Theory of Limits	93- 94	86
F. Algebraic-Geometric Complex	95- 99	88
G. Algebraic-Geometric Proofs Through Similar Polygons, Not Squares	100-103	91
II. Geometric Proofs--10 Types		97
A-Type. All three sq's const'd exterior	104-171	98
B-Type. The h-square const'd interior	172-193	144
C-Type. The b-square const'd interior	194-209	158
D-Type. The a-square const'd interior	210-216	165
E-Type. The h- and b-sq's const'd interior	217-224	169
F-Type. The h- and a-sq's const'd interior	225-228	174
G-Type. The a- and b-sq's const'd interior	229-247	176
H-Type. All three sq's const'd interior	248-255	185

	Figures	Page
I-Type. One or more squares translated, giving 7 classes covering 19 different cases		189
(1) Four cases	256-260	191
(2) Four cases	261-276	193
(3) Four cases	277-288	201
(4) Two cases	289-290	206
(5) Two cases	291-293	208
(6) Two cases	294-305	209
(7) One case	306	215
J-Type. One or more of the squares not graphically represented--Two sub-types		216
(A) Proof derived through a square, giving 7 classes covering 45 distinct cases		216
(1) Twelve cases, but 2 given	307-309	218
(2) Twelve cases, but 1 given	310-311	219
(3) Twelve cases, none given	0	
(4) Three cases,	312-313	221
(5) Three cases, none given	0	
(6) Three cases, all 3 given	314-328	222
(B) Proof based upon a triangle through calculations and comparisons of equivalent areas	329-346	230
Why No Trigonometric, Analytic Geometry Nor Calculus Proof Possible		244
III. Quaternionic Proofs	347-350	246
IV. Dynamic Proofs	351-353	248
A Pythagorean Curiosity	354	252
Pythagorean Magic Squares	355-359	254
Addenda	360-366	258
Bibliography		271
Testimonials		277
Index		281

PORTRAITS

1. Loomis, Elisha S.	Frontispiece	
2. Copernicus	facing page	88
3. Descartes	" "	244
4. Euclid	" "	118
5. Galileo	" "	188
6. Gauss	" "	16
7. Leibniz	" "	58
8. Lobachevsky	" "	210
9. Napier	" "	144
10. Newton	" "	168
11. Pythagoras	" "	8
12. Sylvester	" "	266

ACKNOWLEDGMENTS

Every man builds upon his predecessors.

My predecessors made this work possible, and may those who make further investigations relative to this renowned proposition do better than their predecessors have done.

The author herewith expresses his obligations:

To the many who have preceded him in this field, and whose text and proof he has acknowledged herein on the page where such proof is found;

To those who, upon request, courteously granted him permission to make use of such proof, or refer to the same;

To the following Journals and Magazines whose owners so kindly extended to him permission to use proofs found therein, viz.:

The American Mathematical Monthly;
Heath's Mathematical Monographs;
The Journal of Education;
The Mathematical Magazine;
The School Visitor;
The Scientific American Supplement;
Science and Mathematics; and
Science.

To Theodore H. Johnston, Ph.D., formerly Principal of the West High School, Cleveland, Ohio, for his valuable stylistic suggestions after reading the original manuscript in 1907.

To Professor Oscar Lee Dustheimer, Professor of Mathematics and Astronomy, Baldwin-Wallace College, Berea, Ohio, for his professional assistance and advice; and to David P. Simpson, 33^o, former Principal of West High School, Cleveland, Ohio, for his brotherly encouragement, and helpful suggestions, 1926.

To Dr. Jehuthiel Ginsburg, publisher of Scripta Mathematica, New York City, for the right to reproduce the photo plates of ten of his "Portraits of Eminent Mathematicians."

To Elatus G. Loomis for his assistance in drawing the 366 figures which appear in this Second Edition.

And to "The Masters and Wardens Association of The 22nd Masonic District of the Most Worshipful Grand Lodge of Free and Accepted Masons of Ohio," owner of the Copyright granted to it in 1927, for its generous permission to publish this Second Edition of The Pythagorean Proposition, the author agreeing that a complimentary copy of it shall be sent to the known Mathematical Libraries of the World, for private research work, and also to such Masonic Bodies as it shall select. (April 27, 1940)

ABBREVIATIONS AND CONTRACTIONS

- Am. Math. Mo. = The American Mathematical Monthly,
100 proofs, 1894.
- a-square = square upon the shorter leg.
b-square = " " " longer leg.
- Colbrun = Arthur R. Colbrun, LL.M., Dist. of Columbia
Bar.
- const. = construct.
const'd = constructed.
- cos = cosine.
- Dem. = demonstrated, or demonstration.
- Edw. Geom. = Edward's Elements of Geometry, 1895.
- eq. = equation.
eq's = equations.
- Fig. or fig. = figure.
- Fourrey = E. Fourrey's Curiosities Geometriques.
- Heath = Heath's Mathematical Monographs, 1900,
Parts I and II--26 proofs.
- h-square = square upon the hypotenuse.
- Jour. Ed'n = Journal of Education.
- Legendre = Davies Legendre, Geometry, 1858.
- Math. = mathematics
- Math. Mo. = Mathematical Monthly, 1858-9.
- Mo. = Monthly.
- No. or no. = number.
- Olney's Geom. = Olney's Elements of Geometry, Uni-
versity Edition.
- outw'ly = outwardly.
- par. = parallel.
- paral. = parallelogram.
- perp. = perpendicular.
- p. = page.
- pt. = point.
- quad. = quadrilateral.
- resp'y = respectively.

Richardson = John M. Richardson--28 proofs.

rt. = right.

rt. tri. = right triangle.

rect. = rectangle.

Sci. Am. Supt. = Scientific American Supplement,
1910, Vol. 70.

sec = secant.

sin = sine.

sq. = square.

sq's = squares.

tang = tangent.

∴ = therefore.

tri. = triangle.

tri's = triangles.

trap. = trapezoid.

V. or v. = volume.

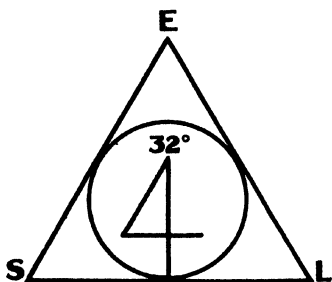
Versluys = Zes en Negentic (96) Beweijzen Voor Het
Theorema Van Pythagoras, by J. Versluys, 1914.

Wipper = Jury Wipper's "46 Beweise der Pythagor-
aischen Lehrsatzes," 1880.

HE², or any like symbol = the square of, or upon, the
line HE, or like symbol.

AC|AF, or like symbol = AC + AF, or $\frac{AC}{AF}$. See proof 17.

ὁμιλεῖν τῷ Θεῷ



**GOD GEOMETRIZES
CONTINUALLY~PLATO.**

THE PYTHAGOREAN PROPOSITION

This celebrated proposition is one of the most important theorems in the whole realm of geometry and is known in history as the 47th proposition, that being its number in the first book of Euclid's Elements.

It is also (erroneously) sometimes called the Pons Asinorum. Although the practical application of this theorem was known long before the time of Pythagoras he, doubtless, generalized it from an Egyptian rule of thumb ($3^2 + 4^2 = 5^2$) and first demonstrated it about 540 B.C., from which fact it is generally known as the Pythagorean Proposition. This famous theorem has always been a favorite with geometers.

(The statement that Pythagoras was the inventor of the 47th proposition of Euclid has been denied by many students of the subject.)

Many purely geometric demonstrations of this famous theorem are accessible to the teacher, as well as an unlimited number of proofs based upon the algebraic method of geometric investigation. Also quaternions and dynamics furnish a few proofs.

No doubt many other proofs than these now known will be resolved by future investigators, for the possibilities of the algebraic and geometric relations implied in the theorem are limitless.

This theorem with its many proofs is a striking illustration of the fact that there is more than one way of establishing the same truth.

But before proceeding to the methods of demonstration, the following historical account translated from a monograph by Jury Wipper, published in 1880, and entitled "46 Beweise des Pythagoraischen Lehrsatzes," may prove both interesting and profitable.

Wipper acknowledges his indebtedness to F. Graap who translated it out of the Russian. It is as follows: "One of the weightiest propositions in geometry if not the weightiest with reference to its deductions and applications is doubtless the so-called Pythagorean proposition."

The Greek text is as follows:

Ἐν τοῖς ὀρθογωνοῖς τὸ ἀπὸ τῆς τῆν ὀρθῆν
γωνίαν ὑποτεينوῦσης πλευρᾶς τετράγωνον ἴσον ἐστὶ τοῖς
ἀπὸ τῶν τῆν ὀρθῆν γωνίαν περιεχουσῶν πλευρῶν
τετραγῶνους.

The Latin reads: In rectangulis triangulis quadratum, quod a latere rectum angulum subtendente describitur, aequale est eis, quae a lateribus rectum angulum continentibus describuntur.

German: In den rechtwinkeligen Dreiecken ist das Quadrat, welches von der dem rechten Winkel gegenüber liegenden Seite beschrieben wird, den Quadraten, welche von den ihn umschliessenden Seiten beschrieben werden, gleich.

According to the testimony of Proklos the demonstration of this proposition is due to Euclid who adopted it in his elements (I, 47). The method of the Pythagorean demonstration remains unknown to us. It is undecided whether Pythagoras himself discovered this characteristic of the right triangle, or learned it from Egyptian priests, or took it from Babylon: regarding this opinions vary.

According to that one most widely disseminated Pythagoras learned from the Egyptian priests the characteristics of a triangle in which one leg = 3 (designating Osiris), the second = 4 (designating Isis), and the hypotenuse = 5 (designating Horus): for which reason the triangle itself is also named the Egyptian or Pythagorean.*

* (Note. The Grand Lodge Bulletin, A.F. and A.M., of Iowa, Vol. 30, No. 2, Feb. 1929, p. 42, has: In an old Egyptian manuscript, recently discovered at Kahan, and supposed to belong

The characteristics of such a triangle, however, were known not to the Egyptian priests alone, the Chinese scholars also knew them. "In Chinese history," says Mr. Skatschkow, "great honors are awarded to the brother of the ruler Uwan, Tschou-Gun, who lived 1100 B.C.: he knew the characteristics of the right triangle, (perfected) made a map of the stars, discovered the compass and determined the length of the meridian and the equator.

Another scholar (Cantor) says: this emperor wrote or shared in the composition of a mathematical treatise in which were discovered the fundamental features, ground lines, base lines, of mathematics, in the form of a dialogue between Tschou-Gun and Schau-Gao. The title of the book is: Tschaou pi, i.e., the high of Tschao. Here too are the sides of a triangle already named legs as in the Greek, Latin, German and Russian languages.

Here are some paragraphs of the 1st chapter of the work. Tschou-Gun once said to Schau-Gao: "I learned, sir, that you know numbers and their applications, for which reason I would like to ask how old Fo-chi determined the degrees of the celestial sphere. There are no steps on which one can climb up to the sky, the chain and the bulk of the earth are also inapplicable; I would like for this reason, to know how he determined the numbers."

Schau-Gao replied: "The art of counting goes back to the circle and square."

If one divides a right triangle into its parts the line which unites the ends of the sides

(Footnote continued) to the time of the Twelfth Dynasty, we find the following equations: $1^2 + (\frac{3}{4})^2 = (1\frac{1}{4})^2$; $8^2 + 6^2 = 10^2$; $2^2 + (1\frac{1}{2})^2 = (2\frac{1}{2})^2$; $16^2 + 12^2 = 20^2$; all of which are forms of the 3-4-5 triangle. ...We also find that this triangle was to them the symbol of universal nature. The base 4 represented Osiris; the perpendicular 3, Isis; and the hypotenuse represented Horus, their son, being the product of the two principles, male and female.)

when the base = 3, the altitude = 4 is 5.

Tschou-Gun cried out: "That is indeed excellent."

It is to be observed that the relations between China and Babylon more than probably led to the assumption that this characteristic was already known to the Chaldeans. As to the geometrical demonstration it comes doubtless from Pythagoras himself. In busying with the addition of the series he could very naturally go from the triangle with sides 3, 4 and 5, as a single instance to the general characteristics of the right triangle.

After he observed that addition of the series of odd number ($1 + 3 = 4$, $1 + 3 + 5 = 9$, etc.) gave a series of squares, Pythagoras formulated the rule for finding, logically, the sides of a right triangle: Take an odd number (say 7) which forms the shorter side, square it ($7^2 = 49$), subtract one ($49 - 1 = 48$), halve the remainder ($48 - 2 = 24$); this half is the longer side, and this increased by one ($24 + 1 = 25$), is the hypotenuse.

The ancients recognized already the significance of the Pythagorean proposition for which fact may serve among others as proof the account of Diogenes Laertius and Plutarch concerning Pythagoras. The latter is said to have offered (sacrificed) the Gods an ox in gratitude after he learned the notable characteristics of the right triangle. This story is without doubt a fiction, as sacrifice of animals, i.e., blood-shedding, antagonizes the Pythagorean teaching.

During the middle ages this proposition which was also named *inventum hecatombe dignum* (in-as-much as it was even believed that a sacrifice of a hecatomb--100 oxen--was offered) won the honor-designation *Magister matheseos*, and the knowledge thereof was some decades ago still the proof of a solid mathematical training (or education). In examinations to obtain the master's degree this proposition was often given; there was indeed a time, as is maintained,

when from every one who submitted himself to the test as master of mathematics a new (original) demonstration was required.

This latter circumstance, or rather the great significance of the proposition under consideration was the reason why numerous demonstrations of it were thought out.

The collection of demonstrations which we bring in what follows,* must, in our opinion, not merely satisfy the simple thirst for knowledge, but also as important aids in the teaching of geometry. The variety of demonstrations, even when some of them are finical, must demand in the learners the development of rigidly logical thinking, must show them how many sidedly an object can be considered, and spur them on to test their abilities in the discovery of like demonstrations for the one or the other proposition."

Brief Biographical Information Concerning Pythagoras

"The birthplace of Pythagoras was the island of Samos; there the father of Pythagoras, Mnessarch, obtained citizenship for services which he had rendered the inhabitants of Samos during a time of famine. Accompanied by his wife Pithay, Mnessarch frequently traveled in business interests; during the year 569 A.C. he came to Tyre; here Pythagoras was born. At eighteen Pythagoras, secretly, by night, went from (left) Samos, which was in the power of the tyrant Polycrates, to the island Lesbos to his uncle who welcomed him very hospitably. There for two years he received instruction from Ferekid who with Anaksimander and Thales had the reputation of a philosopher.

*Note. There were but 46 different demonstrations in the monograph by Jury Wipper, which 46 are among the classified collection found in this work.

After Pythagoras had made the religious ideas of his teacher his own, he went to Anaksimander and Thales in Miletus (549 A.C.). The latter was then already 90 years old. With these men Pythagoras studied chiefly cosmography, i.e., Physics and Mathematics.

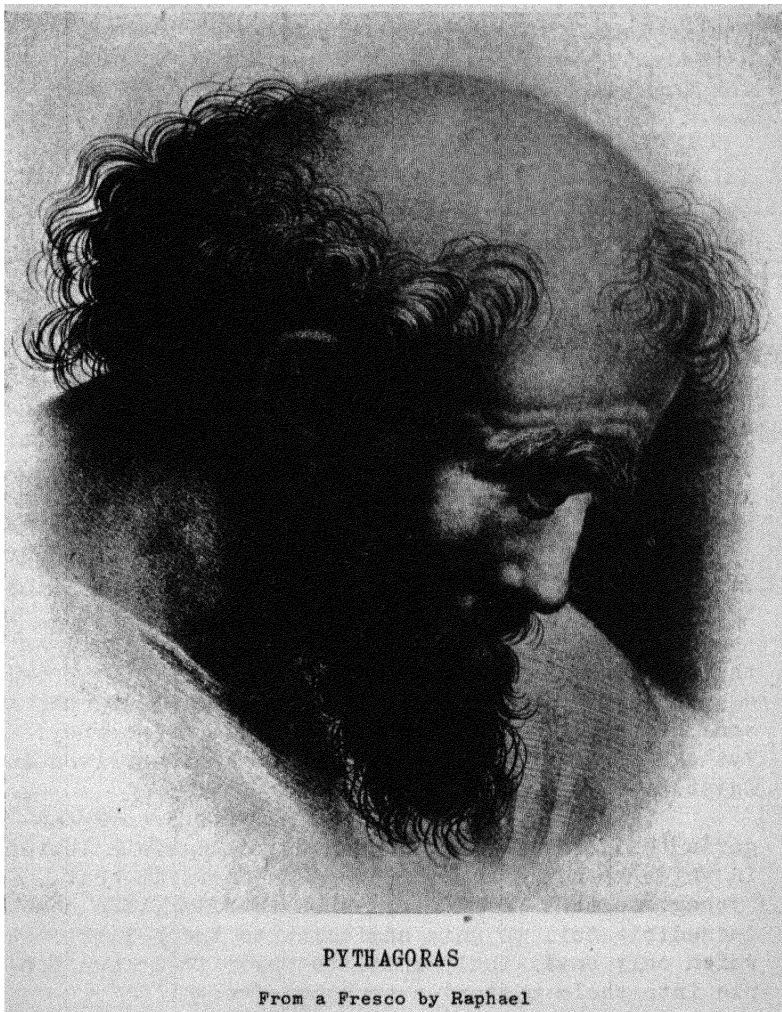
Of Thales it is known that he borrowed the solar year from Egypt; he knew how to calculate sun and moon eclipses, and determine the elevation of a pyramid from its shadow; to him also are attributed the discovery of geometrical projections of great import; e.g., the characteristic of the angle which is inscribed and rests with its sides on the diameter, as well as the characteristics of the angle at the base of an (equilateral) isosceles triangle.

Of Anaksimander it is known that he knew the use of the dial in the determination of the sun's elevation; he was the first who taught geography and drew geographical maps on copper. It must be observed too, that Anaksimander was the first prose writer, as down to his day all learned works were written in verse, a procedure which continued longest among the East Indians.

Thales directed the eager youth to Egypt as the land where he could satisfy his thirst for knowledge. The Phoenician priest college in Sidon must in some degree serve as preparation for this journey. Pythagoras spent an entire year there and arrived in Egypt 547.

Although Polikrates who had forgiven Pythagoras' nocturnal flight addresses to Amasis a letter in which he commended the young scholar, it cost Pythagoras as a foreigner, as one unclean, the most incredible toil to gain admission to the priest caste which only unwillingly initiated even their own people into their mysteries or knowledge.

The priests in the temple Heliopolis to whom the king in person brought Pythagoras declared it impossible to receive him into their midst, and directed him to the oldest priest college at Memphis, this



PYTHAGORAS

From a Fresco by Raphael

commended him to Thebes. Here somewhat severe conditions were laid upon Pythagoras for his reception into the priest caste; but nothing could deter him. Pythagoras performed all the rites, and all tests, and his study began under the guidance of the chief priest Sonchis.

During his 21 years stay in Egypt Pythagoras succeeded not only in fathoming and absorbing all the Egyptian but also became sharer in the highest honors of the priest caste.

In 527 Amasis died; in the following (526) year in the reign of Psammenit, son of Amasis, the Persian king Kambis invaded Egypt and loosed all his fury against the priest caste.

Nearly all members thereof fell into captivity, among them Pythagoras, to whom as abode Babylon was assigned. Here in the center of the world commerce where Bactrians, Indians, Chinese, Jews and other folk came together, Pythagoras had during 12 years stay opportunity to acquire those learnings in which the Chaldeans were so rich.

A singular accident secured Pythagoras liberty in consequence of which he returned to his native land in his 56th year. After a brief stay on the island Delos where he found his teacher Ferekid still alive, he spent a half year in a visit to Greece for the purpose of making himself familiar with the religious, scientific and social condition thereof.

The opening of the teaching activity of Pythagoras, on the island of Samos, was extraordinarily sad; in order not to remain wholly without pupils he was forced even to pay his sole pupil, who was also named Pythagoras, a son of Eratokles. This led him to abandon his thankless land and seek a new home in the highly cultivated cities of Magna Graecia (Italy).

In 510 Pythagoras came to Kroton. As is known it was a turbulent year. Tarquin was forced to flee from Rome, Hippias from Athens; in the neighborhood of Kroton, in Sibaris, insurrection broke out.

The first appearance of Pythagoras before the people of Kroton began with an oration to the youth

wherein he rigorously but at the same time so convincingly set forth the duties of young men that the elders of the city entreated him not to leave them without guidance (counsel). In his second oration he called attention to law abiding and purity of morals as the buttresses of the family. In the two following orations he turned to the matrons and children. The result of the last oration in which he specially condemned luxury was that thousands of costly garments were brought to the temple of Hera, because no matron could make up her mind to appear in them on the street.

Pythagoras spoke captivatingly, and it is for this reason not to be wondered at that his orations brought about a change in the morals of Kroton's inhabitants; crowds of listeners streamed to him. Besides the youth who listened all day long to his teaching some 600 of the worthiest men of the city, matrons and maidens, came together at his evening entertainments; among them was the young, gifted and beautiful Theana, who thought it happiness to become the wife of the 60 year old teacher.

The listeners divided accordingly into disciples, who formed a school in the narrower sense of the word, and into auditors, a school in the broader sense. The former, the so-called mathematicians were given the rigorous teaching of Pythagoras as a scientific whole in logical succession from the prime concepts of mathematics up to the highest abstraction of philosophy; at the same time they learned to regard everything fragmentary in knowledge as more harmful than ignorance even.

From the mathematicians must be distinguished the auditors (university extensioners) out of whom subsequently were formed the Pythagoreans. These took part in the evening lectures only in which nothing rigorously scientific was taught. The chief themes of these lectures were: ethics, immortality of the soul, and transmigration--metempsychology.

About the year 490 when the Pythagorean school reached its highest splendor--brilliance--a

certain Hypasos who had been expelled from the school as unworthy put himself at the head of the democratic party in Kroton and appeared as accuser of his former colleagues. The school was broken up, the property of Pythagoras was confiscated and he himself exiled.

The subsequent 16 years Pythagoras lived in Tarentum, but even here the democratic party gained the upper hand in 474 and Pythagoras a 95-year old man must flee again to Metapontus where he dragged out his poverty-stricken existence 4 years more. Finally democracy triumphed there also; the house in which was the school was burned, many disciples died a death of torture and Pythagoras himself with difficulty having escaped the flames died soon after in his 99th year."*

Supplementary Historical Data

To the following (Graap's) translation, out of the Russian, relative to the great master Pythagoras, these interesting statements are due.

"Fifteen hundred years before the time of Pythagoras, (549-470 B.C.),** the Egyptians constructed right angles by so placing three pegs that a rope measured off into 3, 4 and 5 units would just reach around them, and for this purpose professional 'rope fasteners' were employed.

"Today carpenters and masons make right angles by measuring off 6 and 8 feet in such a manner that a 'ten-foot pole' completes the triangle.

"Out of this simple Nile-compelling problem of these early Egyptian rope-fasteners Pythagoras is said to have generalized and proved this important and famous theorem,--the square upon the hypotenuse

*Note. The above translation is that of Dr. Theodore H. Johnston, Principal (1907) of the West High School, Cleveland, O.

**Note. From recent accredited biographical data as to Pythagoras, the record reads: "Born at Samos, c. 582 B.C. Died probably at Metapontum, c. 501, B.C."

of a right triangle is equal to the sum of the squares upon its two legs,--of which the right triangle whose sides are 3, 4 and 5 is a simple and particular case; and for having proved the universal truth implied in the 3-4-5 triangle, he made his name immortal--written indelibly across the ages.

In speaking of him and his philosophy, the Journal of the Royal Society of Canada, Section II, Vol. 10, 1904, p. 239, says: "He was the Newton, the Galileo, perhaps the Edison and Marconi of his Epoch....'Scholars now go to Oxford, then to Egypt, for fundamentals of the past....The philosophy of Pythagoras is Asiatic--the best of India--in origin, in which lore he became proficient; but he committed none of his views to writing and forbid his followers to do so, insisting that they listen and hold their tongues.'"

He was indeed the Sarvonarola of his epoch; he excelled in philosophy, mysticism, geometry, a writer upon music, and in the field of astronomy he anticipated Copernicus by making the sun the center of the cosmos. "His most original mathematical work however, was probably in the Greek Arithmetica, or theory of numbers, his teachings being followed by all subsequent Greek writers on the subject."

Whether his proof of the famous theorem was wholly original no one knows; but we now know that geometers of Hindustan knew this theorem centuries before his time; whether he knew what they knew is also unknown. But he, of all the masters of antiquity, carries the honor of its place and importance in our Euclidian Geometry.

On account of its extensive application in the field of trigonometry, surveying, navigation and astronomy, it is one of the most, if not the most, interesting propositions in elementary plane geometry.

It has been variously denominated as, the Pythagorean Theorem, The Hecatomb Proposition, The Carpenter's Theorem, and the Pons Asinorum because of its supposed difficulty. But the term "Pons Asinorum"

also attaches to Theorem V, properly, and to Theorem XX erroneously, of Book I of Euclid's Elements of Geometry.

It is regarded as the most fascinating Theorem of all Euclid, so much so, that thinkers from all classes and nationalities, from the aged philosopher in his armchair to the young soldier in the trenches next to no-man's-land, 1917, have whiled away hours seeking a new proof of its truth.

Camerer,* in his notes on the First Six Books of Euclid's Elements gives a collection of 17 different demonstrations of this theorem, and from time to time others have made collections,--one of 28, another of 33, Wipper of 46, Versluys of 96, the American Mathematical Monthly has 100, others of lists ranging from a few to over 100, all of which proofs, with credit, appears in this (now, 1940) collection of over 360 different proofs, reaching in time, from 900 B.C., to 1940 A.D.

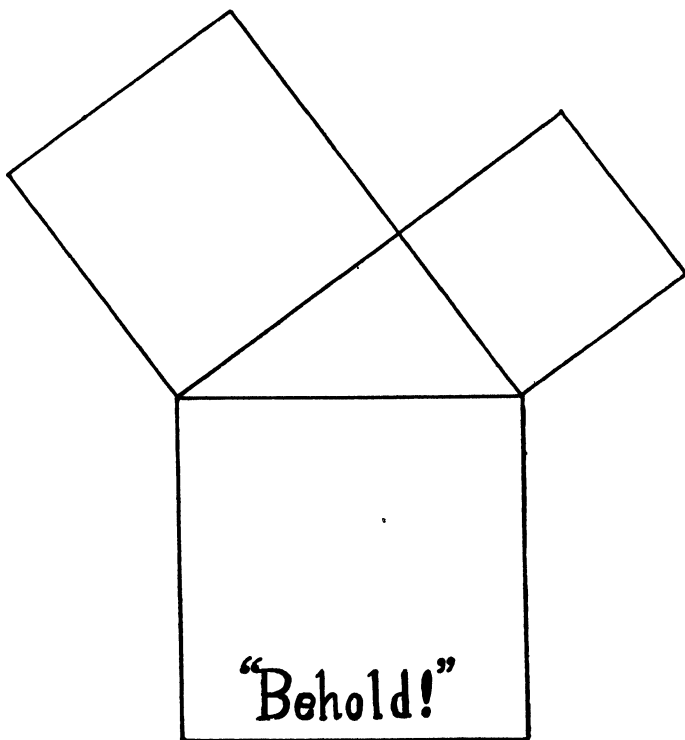
Some of these 367 proofs,--supposed to be new--are very old; some are short and simple; others are long and complex; but each is a way of proving the same truth.

Read and take your choice; or better, find a new, a different proof, for there are many more proofs possible, whose figure will be different from any one found herein.

*Note. Perhaps J.G. See Notes and Queries, 1879, Vol. V, No. 41, p. 41.

Come and take choice of all my Library.

—*Titus Andronicus.*



Viam Inveniam aut Faciam.

"Mathematics is queen of the sciences and arithmetic is queen of Mathematics. She often condescends to render service to astronomy and other natural sciences, but under all circumstances the first place is her due."

Gauss (1777-1855)



CARL FRIEDRICH GAUSS
1777-1855

THE PYTHAGOREAN THEOREM
From an Arithmetico-Algebraic Point of View

Dr. J. W. L. Glashier in his address before Section A of the British Association for the Advancement of Science, 1890, said: "Many of the greatest masters of the Mathematical Sciences were first attracted to mathematical inquiry by problems concerning numbers, and no one can glance at the periodicals of the present day which contains questions for solution without noticing how singular a charm such problems continue to exert."

One of these charming problems was the determination of "Triads of Arithmetical Integers" such that the sum of the squares of the two lesser shall equal the square of the greater number.

These triads, groups of three, represent the three sides of a right triangle, and are infinite in number.

Many ancient master mathematicians sought general formulas for finding such groups, among whom worthy of mention were Pythagoras (c. 582-c. 501 B.C.), Plato (429-348 B.C.), and Euclid (living 300 B.C.), because of their rules for finding such triads.

In our public libraries may be found many publications containing data relating to the sum of two square numbers whose sum is a square number among which the following two mathematical magazines are especially worthy of notice, the first being "The Mathematical Magazine," 1891, Vol. II, No. 5, in which, p. 69, appears an article by that master Mathematical Analyst, Dr. Artemas Martin, of Washington, D.C.; the second being "The American Mathematical Monthly," 1894, Vol. I, No. 1, in which, p. 6, appears an article by Leonard E. Dickson, B.Sc., then Fellow in Pure Mathematics, University of Texas.

Those who are interested and desire more data relative to such numbers than here culled therefrom, the same may be obtained from these two Journals.

From the article by Dr. Martin: "Any number of square numbers whose sum is a square number can be found by various rigorous methods of solution."

Case I. Let it be required to find two square numbers whose sum is a square number.

First Method. Take the well-known identity $(x + y)^2 = x^2 + 2xy + y^2 = (x - y)^2 + 4xy$. ---(1)

Now if we can transform $4xy$ into a square we shall have expressions for two square numbers whose sum is a square number.

Assume $x = mp^2$ and $y = mq^2$, and we have $4xy = 4m^2p^2q^2$, which is a square number for all values of m , p and q ; and (1) becomes, by substitution, $(mp^2 + mq^2)^2 = (mp^2 - mq^2)^2 + (2mpq)^2$, or striking out the common square factor m^2 , we have $(p^2 + q^2)^2 = (p^2 - q^2)^2 + (2pq)^2$. ---(2)

Dr. Martin follows this by a second and a third method, and discovers that both (second and third) methods reduce, by simplification, to formula (2).

Dr. Martin declares, (and supports his declaration by the investigation of Matthew Collins' "Tract on the Possible and Impossible Cases of Quadratic Duplicate Equalities in the Diophantine Analysis," published at Dublin in 1858), that no expression for two square numbers whose sum is a square can be found which are not deducible from this, or reducible to this formula,--that $(2pq)^2 + (p^2 - q^2)^2$ is always equal to $(p^2 + q^2)^2$.

His numerical illustrations are:

Example 1. Let $p = 2$, and $q = 1$; then $p^2 + q^2 = 5$, $p^2 - q^2 = 3$, $2pq = 4$, and we have $3^2 + 4^2 = 5^2$.

Example 2. Let $p = 3$, $q = 2$; then $p^2 + q^2 = 13$, $p^2 - q^2 = 5$, $2pq = 12$. $\therefore 5^2 + 12^2 = 13^2$, etc., ad infinitum.

From the article by Mr. Dickson: 'Let the three integers used to express the three sides of a right triangle be prime to each other, and be symbolized by a , b and h .' Then these facts follow:

1. They can not all be even numbers, otherwise they would still be divisible by the common divisor 2.
2. They can not all be odd numbers. For $a^2 + b^2 = h^2$. And if a and b are odd, their squares are odd, and the sum of their squares is even; i.e., h^2 is even. But if h^2 is even h must be even.
3. h must always be odd; and, of the remaining two, one must be even and the other odd. So two of the three integers, a , b and h , must always be odd. (For proof, see p. 7, Vol. I, of said Am. Math. Monthly.)
4. When the sides of a right triangle are integers, the perimeter of the triangle is always an even number, and its area is also an even number.

Rules for finding integral values for a , b and h .

1. Rule of Pythagoras: Let n be odd; then n , $\frac{n^2 - 1}{2}$ and $\frac{n^2 + 1}{2}$ are three such numbers. For
$$n^2 + \left(\frac{n^2 - 1}{2}\right)^2 = \frac{4n^2 + n^4 - 2n^2 + 1}{4} = \left(\frac{n^2 + 1}{2}\right)^2.$$
2. Plato's Rule: Let m be any even number divisible by 4; then m , $\frac{m^2}{4} - 1$, and $\frac{m^2}{4} + 1$ are three such numbers. For
$$m^2 + \left(\frac{m^2}{4} - 1\right)^2 = m^2 + \frac{m^4}{16} - \frac{m^2}{2} + 1 = \frac{m^4}{16} + \frac{m^2}{2} + 1 = \left(\frac{m^2}{4} + 1\right)^2.$$
3. Euclid's Rule: Let x and y be any two even or odd numbers, such that x and y contain no common factor greater than 2, and xy is a square. Then \sqrt{xy} , $\frac{x - y}{2}$ and $\frac{x + y}{2}$ are three such numbers. For

$$(\sqrt{xy})^2 + \left(\frac{x-y}{2}\right)^2 = xy + \frac{x^2 - 2xy + y^2}{4} = \left(\frac{x+y}{2}\right)^2.$$

4. Rule of Maseres (1721-1824): Let m and n be any two even or odd, $m > n$, and $\frac{m^2 + n^2}{2n}$ an integer.

Then m^2 , $\frac{m^2 - n^2}{2n}$ and $\frac{m^2 + n^2}{2n}$ are three such numbers.

$$\begin{aligned} \text{For } m^2 + \frac{m^2 - n^2}{2n} &= \frac{4m^2n^2 + m^4 - 2m^2 + n^2 + n^4}{4n^2} \\ &= \left(\frac{m^2 + n^2}{2n}\right)^2. \end{aligned}$$

5. Dickson's Rule: Let m and n be any two prime integers, one even and the other odd, $m > n$ and $2mn$ a square. Then $m + \sqrt{2mn}$, $n + \sqrt{2mn}$ and $m + n + \sqrt{2mn}$ are three such numbers. For $(m + \sqrt{2mn})^2 + (n + \sqrt{2mn})^2 + m^2 + n^2 + 4mn + 2m\sqrt{2mn} + 2n\sqrt{2mn} = (m + n + \sqrt{2mn})^2$.
6. By inspection it is evident that these five rules, --the formulas of Pythagoras, Plato, Euclid, Maseres and Dickson, --each reduces to the formula of Dr. Martin.

In the Rule of Pythagoras: multiply by 4 and square and there results $(2n)^2 + (n^2 - 1)^2 = (n^2 + 1)^2$, in which $p = n$ and $q = 1$.

In the Rule of Plato: multiply by 4 and square and there results $(2m)^2 + (m^2 - 2^2)^2 = (m^2 + 2^2)^2$, in which $p = m$ and $q = 2$.

In the Rule of Euclid: multiply by 2 and square there results $(2xy)^2 + (x - y)^2 = (x + y)^2$, in which $p = x$ and $q = y$.

In the Rule of Maseres: multiply by $2n$ and square and results are $(2mn)^2 + (m^2 - n^2)^2 = (m^2 + n^2)^2$, in which $p = m$ and $q = n$.

In Rule of Dickson: equating and solving

$$p = \sqrt{\frac{m + n + 2\sqrt{2mn} + \sqrt{m - n}}{2}} \quad \text{and}$$

$$q = \sqrt{\frac{m + n + 2\sqrt{2mn} - \sqrt{m - n}}{2}} .$$

Or if desired, the formulas of Martin, Pythagoras, Plato, Euclid and Maseres may be reduced to that of Dickson.

The advantage of Dickson's Rule is this: It gives every possible set of values for a, b and h in their lowest terms, and gives this set but once.

To apply his rule, proceed as follows: Let m be any odd square whatsoever, and n be the double of any square number whatsoever not divisible by m.

Examples. If $m = 9$, n may be the double of 1, 4, 16, 25, 49, etc.; thus when $m = 9$, and $n = 2$, then $m + \sqrt{2mn} = 15$, $n + \sqrt{2mn} = 8$, $m + n + \sqrt{2mn} = 17$. So $a = 8$, $b = 15$ and $h = 17$.

If $m = 1$, and $n = 2$, we get $a = 3$, $b = 4$, $h = 5$.

If $m = 25$, and $n = 8$, we get $a = 25$, $b = 45$, $h = 53$, etc., etc.

Tables of integers for values of a, b and h have been calculated.

Halsted's Table (in his "Mensuration") is absolutely complete as far as the 59th set of values.

METHODS OF PROOF

Method is the following of one thing through another. Order is the following of one thing after another.

The type and form of a figure necessarily determine the possible argument of a derived proof; hence, as an aid for reference, an order of arrangement of the proofs is of great importance.

In this exposition of some proofs of the Pythagorean theorem the aim has been to classify and arrange them as to method of proof and type of figure used; to give the name, in case it has one, by which the demonstration is known; to give the name and page of the journal, magazine or text wherein the proof may be found, if known; and occasionally to give other interesting data relative to certain proofs.

The order of arrangement herein is, only in part, my own, being formulated after a study of the order found in the several groups of proofs examined, but more especially of the order of arrangement given in *The American Mathematical Monthly*, Vols. III and IV, 1896-1899.

It is assumed that the person using this work will know the fundamentals of plane geometry, and that, having the figure before him, he will readily supply the "reasons why" for the steps taken as, often from the figure, the proof is obvious; therefore only such statements of construction and demonstration are set forth in the text as is necessary to establish the argument of the particular proof.

The Methods of Proof Are:

I. ALGEBRAIC PROOFS THROUGH LINEAR RELATIONS

A. Similar Right Triangles

From linear relations of similar right triangles it may be proven that, *The square of the hypotenuse of a right triangle is equal to the sum of the squares of the other two sides.*

And since the algebraic square is the measure of the geometric square, the truth of the proposition as just stated involves the truth of the proposition as stated under Geometric Proofs through comparison of areas. Some algebraic proofs are the following:

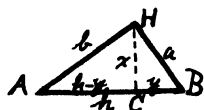
One

Fig. 1

In rt. tri. ABH, draw HC perp. to AB. The tri's ABH, ACH and HCB are similar. For convenience, denote BH, HA, AB, HC, CB and AC by a , b , h , x , y and $h-y$ resp'y. Since, from three similar and related triangles, there are possible nine simple proportions, these proportions

and their resulting equations are:

- (1) $a : x = b : h - y \therefore ah - ay = bx.$
- (2) $a : y = b : x \therefore ax = by.$
- (3) $x : y = h - y : x \therefore x^2 = hy - y^2.$
- (4) $a : x = h : b \therefore ab = hx.$
- (5) $a : y = h : a \therefore a^2 = hy.$
- (6) $x : y = b : a \therefore ax = by.$
- (7) $b : h - y = h : b \therefore b^2 = h^2 - hy.$
- (8) $b : x = h : a \therefore ab = hx.$
- (9) $h - y : x = b : a \therefore ah - ay = bx.$ See Versluys, p. 86, fig. 97, Wm. W. Rupert.

Since equations (1) and (9) are identical, also (2) and (6), and (4) and (8), there remain but six different equations, and the problem becomes,

how may these six equations be combined so as to give the desired relation $h^2 = a^2 + b^2$, which geometricaly interpreted is $AB^2 = BH^2 + HA^2$.

In this proof *One*, and in every case hereafter, as in proof *Sixteen*, p. 41, the symbol AB^2 , or a like symbol, signifies \overline{AB}^2 .

Every rational solution of $h^2 = a^2 + b^2$ affords a Pythagorean triangle. See "Mathematical Monograph, No. 16, Diophantine Analysis," (1915), by R. D. Carmichael.

1st.--Legendre's Solution

a. From no single equation of the above nine can the desired relation be determined, and there is but one combination of two equations which will give it; viz., (5) $a^2 = hy$; (7) $b^2 = h^2 - hy$; adding these gives $h^2 = a^2 + b^2$.

This is the shortest proof possible of the Pythagorean Proposition.

b. Since equations (5) and (7) are implied in the principle that homologous sides of similar triangles are proportional it follows that the truth of this important proposition is but a corollary to the more general truth--the law of similarity.

c. See Davis Legendre, 1858, p. 112,
Journal of Education, 1888, V. XXV, p. 404,
fig. V.

Heath's Math. Monograph, 1900, No. 1, p.
19, proof III, or any late text on
geometry.

d. W. W. Rouse Ball, of Trinity College, Cambridge, England seems to think Pythagoras knew of this proof.

2nd.--Other Solutions

a. By the law of combinations there are possible 20 sets of three equations out of the six different equations. Rejecting all sets containing (5) and (7), and all sets containing dependent equations, there are remaining 13 sets from which the elimination of x and y may be accomplished in 44 different

ways, each giving a distinct proof for the relation $h^2 = a^2 + b^2$.

b. See the American Math. Monthly, 1896, V. III, p. 66 or Edward's Geometry, p. 157, fig. 15.

Two

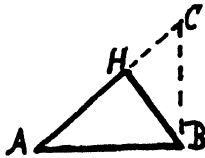


Fig. 2

Produce AH to C so that CB will be perpendicular to AB at B.

Denote BH, HA, AB, BC and CH by a, b, h, x and y resp'y.

The triangles ABH, CAB and BCH are similar.

From the continued proportion $b : h : a = a : x : y = h : b + y : x$, nine different simple proportions are possible, viz.:

- | | |
|---------------------------|--------------------------------|
| (1) $b : h = a : x$. | (7) $a : x = h : b + y$. |
| (2) $b : a = a : y$. | (8) $a : y = h : x$. |
| (3) $h : a = x : y$. | (9) $x : b + y = y : x$, from |
| (4) $b : h = h : b + y$. | which six different |
| (5) $b : a = h : x$. | equations are possible |
| (6) $h : a = b + y : x$. | as in <i>One</i> above. |

1st.--Solutions From Sets of Two Equations

a. As in *One*, there is but one set of two equations, which will give the relation $h^2 = a^2 + b^2$.

b. See Am. Math. Mo., V. III, p. 66.

2nd.--Solution From Sets of Three Equations

a. As in 2nd under proof *One*, fig. 1, there are 13 sets of three eq's, giving 44 distinct proofs that give $h^2 = a^2 + b^2$.

b. See Am. Math. Mo., V. III, p. 66.

c. Therefore from three similar rt. tri's so related that any two have one side in common there are 90 ways of proving that $h^2 = a^2 + b^2$.

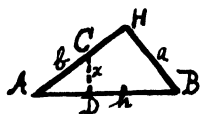
Three

Fig. 3

Take $BD = BH$ and at D draw CD perp. to AB forming the two similar tri's ABH and CAD .

a. From the continued proportion $a : x = b : h = h : b - x$ the simple proportions and their resulting eq's are:

- (1) $a : x = b : h - a \therefore ah - a^2 = bx.$
- (2) $a : x = h : b - x \therefore ab - ax = hx.$
- (3) $b : h - a = h : b - x \therefore b^2 - bx = h^2 - ah.$

As there are but three equations and as each equation contains the unknown x in the 1st degree, there are possible but three solutions giving $h^2 = a^2 + b^2.$

b. See Am. Math. Mo., V. III, p. 66, and Math. Mo., 1859, V. II, No. 2, Dem. Fig. 3, on p. 45 by Richardson.

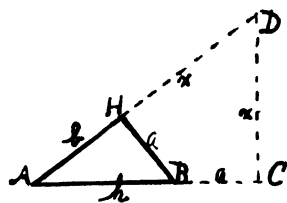
Four

Fig. 4

In Fig. 4 extend AB to C making $BC = BH$, and draw CD perp. to AC . Produce AH to D , forming the two similar tri's ABH and ADC .

From the continued proportion $b : h + a = a : x = h : b + x$ three equations are possible giving, as in fig. 3, three proofs.

a. See Am. Math. Mo., V. III, p. 67.

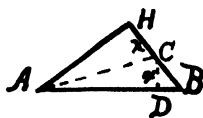
Five

Fig. 5

Draw AC the bisector of the angle HAB , and CD perp. to AB , forming the similar tri's ABH and BCD . Then $CB = a - x$ and $DB = h - b$.

From the continued proportion $h : a - x = a : h - b = b : x$ three equations are possible giving, as in fig. 3, three proofs for $h^2 = a^2 + b^2$.

a. Original with the author, Feb. 23, 1926.

Six

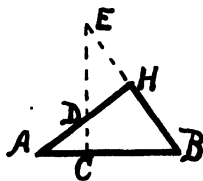


Fig. 6

Through D, any pt. in either leg of the rt. triangle ABH, draw DC perp. to AB and extend it to E a pt. in the other leg produced, thus forming the four similar rt. tri's ABH, BEC, ACD and EHD. From the continued proportion ($AB = h$)

$$\begin{aligned} &: (BE = a + x) : (ED = v) \\ &: (DA = b - y) = (BH = a) : \\ &(BC = h - z) : (DH = y) : (DC = w) \\ = &(HA = b) : (CE = v + w) : (HE = x) : (CA = z), \end{aligned}$$

eighteen simple proportions and eighteen different equations are possible.

From no single equation nor from any set of two eq's can the relation $h^2 = a^2 + b^2$ be found but from combination of eq's involving three, four or five of the unknown elements u, w, x, y, z , solutions may be obtained.

1st.--Proofs From Sets Involving Three Unknown Elements

a. It has been shown that there is possible but one combination of equations involving but three of the unknown elements, viz., x, y and z which will give $h^2 = a^2 + b^2$.

b. See Am. Math. Mo., V. III, p. 111.

2nd.--Proofs From Sets Involving Four Unknown Elements

a. There are possible 114 combinations involving but four of the unknown elements each of which will give $h^2 = a^2 + b^2$.

b. See Am. Math. Mo., V. III, p. 111.

3rd.--Proofs From Sets Involving All Five Unknown Elements

a. Similarly, there are 4749 combinations involving all five of the unknowns, from each of which $h^2 = a^2 + b^2$ can be obtained.

b. See Am. Math. Mo., V. III, p. 112.

c. Therefore the total no. of proofs from the relations involved in fig. 6 is 4864.

Seven

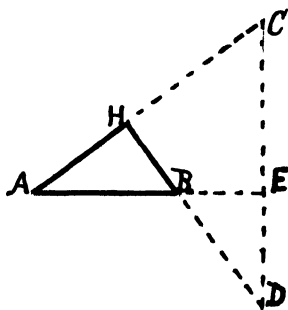


Fig. 7

Produce AB to E, fig. 7, and through E draw, perp. to AE, the line CED meeting AH produced in C and HB produced in D, forming the four similar rt. tri's ABH, DBE, CAE and CDH.

a. As in fig. 6, eighteen different equations are possible from which there are also 4864 proofs.

b. Therefore the total no. of ways of proving that $h^2 = a^2 + b^2$ from 4 similar rt. tri's related as in fig's 6 and 7 is 9728.

c. As the pt. E approaches the pt. B, fig. 7 approached fig. 2, above, and becomes fig. 2, when E falls on B.

d. Suppose E falls on AB so that CE cuts HB between H and B; then we will have 4 similar rt. tri's involving 6 unknowns. How many proofs will result?

Eight

In fig. 8 produce BH to D, making $BD = BA$, and E, the middle pt. of AD, draw EC parallel to AH, and join BE, forming the 7 similar rt. triangles AHD, ECD, BED, BEA, BCE, BHF and AEF, but six of which

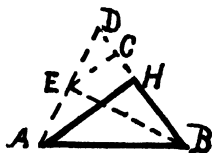


Fig. 8

need consideration, since tri's BED and BEA are congruent and, in symbolization, identical.

See Versluys, p. 87, fig. 98, Hoffmann, 1818.

From these 6 different rt. triangles, sets of 2 tri's may be selected in 15 different ways, sets of 3 tri's may be selected in 20 different ways, sets of 4 tri's may be selected in 15 different ways, sets of 5 tri's may be selected in 6 different ways, and sets of 6 tri's may be selected in 1 way, giving, in all, 57 different ways in which the 6 triangles may be combined.

But as all the proofs derivable from the sets of 2, 3, 4, or 5 tri's are also found among the proofs from the set of 6 triangles, an investigation of this set will suffice for all.

In the 6 similar rt. tri's, let $AB = h$, $BH = a$, $HA = b$, $DE = EA = x$, $BE = y$, $FH = z$ and $BF = v$, whence $EC = \frac{b}{2}$, $DH = h - a$, $DC = \frac{h - a}{2}$, $EF = y - v$, $BE = \frac{h + a}{2}$, $AD = 2x$ and $AF = b - z$, and from these data the continued proportion is

$$\begin{aligned} b : b/2 : y : (h + a)/2 : a : x \\ = h - a : (h - a)/2 : x : b/2 : z : y - v \\ = 2x : x : h : y : v : b - z. \end{aligned}$$

From this continued proportion there result 45 simple proportions which give 28 different equations, and, as groundwork for determining the number of proofs possible, they are here tabulated.

- (1) $b : b/2 = h - a : (h - a)/2$, whence $1 = 1$. Eq. 1.
- (2) $b : b/2 = 2x : x$, whence $1 = 1$. Eq. 1.
- (3) $h - a : (h - a)/2 = 2x : x$, whence $1 = 1$. Eq. 1³.
- (4) $b : y = h - a : x$, whence $bx = (h - a)y$. Eq. 2.
- (5) $b : y = 2x : h$, whence $2xy = bh$. Eq. 3.
- (6) $h - a : x = 2x : h$, whence $2x^2 = h^2 - ah$. Eq. 4.

- (7) $b : (a + h)/2 = h - a : b/2$, whence $b^2 = h^2 - a^2$.
Eq. 5.
- (8) $b : (h + a)/2 = 2x : y$, whence $(h + a)x = by$.
Eq. 6.
- (9) $h - a : b/2 = 2x : y$, whence $bx = (h - a)y$.
Eq. 2.
- (10) $b : a = h - a : z$, whence $bz = (h - a)a$. Eq. 7.
- (11) $b : a = 2x : v$, whence $2ax = bv$. Eq. 8.
- (12) $h - a : z = 2x : v$, whence $2xz = (h - a)v$. Eq. 9.
- (13) $b : x = h - a : y - v$, whence $(h - a)x = b(y - v)$.
Eq. 10.
- (14) $b : x = 2x : b - z$, whence $2x^2 = b^2 - bz$. Eq. 11.
- (15) $h - a : y - v = 2x : b - z$, whence $2(y - v)z = (h - a)(b - z)$. Eq. 12.
- (16) $b/2 : y = (h - a)/2 : x$, whence $bx = (h - a)y$.
Eq. 2.
- (17) $b/2 : y = x : h$, whence $2xy = bh$. Eq. 3.
- (18) $(h - a)/2 : x = x : h$, whence $2x^2 = h^2 - ah$.
Eq. 4².
- (19) $b/2 : (h + a)/2 = (h - a)/2 : b/2$, whence $b^2 = h^2 - a^2$. Eq. 5².
- (20) $b/2 : (h + a)/2 = x : y$, whence $(h + a)x = by$.
Eq. 6.
- (21) $(h - a)/2 : b/2 = x : y$, whence $bx = (h - a)y$.
Eq. 2⁴.
- (22) $b/2 : a = (h - a)/2 : z$, whence $bz = (h - a)a$.
Eq. 7².
- (23) $b/2 : a = x : v$, whence $2ax = bv$. Eq. 8².
- (24) $(h - a)/2 : z = x : v$, whence $2xz = (h - a)v$.
Eq. 9².
- (25) $b/2 : x = (h - a)/2 : y - v$, whence $(h - a)x = b(y - v)$. Eq. 10².
- (26) $b/2 : x = x : b - z$, whence $2x^2 = b^2 - bz$.
Eq. 11².
- (27) $(h - a)/2 : y - v = x : b - z$, whence $2(y - v)x = (h - a)(b - z)$. Eq. 12².
- (28) $y : (h + a)/2 = x : b/2$, whence $(h + a)x = by$.
Eq. 6³.
- (29) $y : (h + a)2 = h : y$, whence $2y^2 = h^2 + ah$.
Eq. 13.

- (30) $x : b/2 = h : y$, whence $2xy = bh$. Eq. 3^o.
 (31) $y : a = x : z$, whence $ax = yz$. Eq. 14.
 (32) $y : a = h : v$, whence $vy = ah$. Eq. 15.
 (33) $x : z = h : v$, whence $vx = hz$. Eq. 16.
 (34) $y : x = x : y - v$, whence $x^2 = y(y - v)$. Eq. 17.
 (35) $y : x = h : b - z$, whence $hx = y(b - z)$. Eq. 18.
 (36) $x : y - v = h : b - z$, whence $(b - z)x = h(y - v)$. Eq. 19.
 (37) $(h + a)/2 : a = b/2 : z$, whence $(h + a)z = ab$. Eq. 20.
 (38) $(h + a)/2 : x = y : v$, whence $2ay = (h + a)v$. Eq. 21.
 (39) $b/2 : z = y : v$, whence $2yz = bv$. Eq. 22.
 (40) $(h + a)/2 : x = b/2 : y - v$, whence $bx = (h + a)(y - v)$. Eq. 23.
 (41) $(h + a)/2 : x = y : b - z$, whence $2xy = (h + a)(b - z)$. Eq. 24.
 (42) $b/2 : y - v = y : b - z$, whence $2y(y - v) = b^2 - bz$. Eq. 25.
 (43) $a : x = z : y - v$, whence $xz = a(y - v)$. Eq. 26.
 (44) $a : x = v : b - z$, whence $vx = a(b - z)$. Eq. 27.
 (45) $z : y - v = v : b - z$, whence $v(y - v) = (b - z)z$. Eq. 28.

The symbol 2^4 , see (21), means that equation 2 may be derived from 4 different proportions. Similarly for 6^3 , etc.

Since a definite no. of sets of dependent equations, three equations in each set, is derivable from a given continued proportion and since these sets must be known and dealt with in establishing the no. of possible proofs for $h^2 = a^2 + b^2$, it becomes necessary to determine the no. of such sets. In any continued proportion the symbolization for the no. of such sets, three equations in each set, is $\frac{n^2(n+1)}{2}$ in which n signifies the no. of simple ratios in a member of the continued prop'n. Hence for the above continued proportion there are derivable 75 such sets of dependent equations. They are:

(1), (2), (3); (4), (5), (6); (7), (8), (9); (10), (11), (12); (13), (14), (15); (16), (17), (18); (19), (20), (21); (22), (23), (24); (25), (26), (27); (28), (29), (30); (31), (32), (33); (34), (35), (36); (37), (38), (39); (40), (41), (42); (43), (44), (45); (1), (4), (16); (1), (7), (19); (1), (10), (22); (1), (13), (25); (4), (7), (28); (4), (10), (31); (4), (13), (34); (7), (10), (37); (7), (13), (40); (10), (13), (43); (16), (19), (20); (16), (22), (31); (16), (25), (34); (19), (22), (37); (19), (25), (40); (22), (25), (43); (28), (31), (37); (28), (34), (40); (31), (34), (43); (37), (40), (43); (2), (5), (17); (2), (8), (20); (2), (11), (23); (2), (14), (26); (5), (8), (29); (5), (11), (32); (5), (14), (35); (8), (11), (38); (8), (14), (41); (11), (14), (44); (17), (20), (29); (17), (23), (32); (17), (26), (35); (20), (23), (38); (20), (26), (41); (23), (26), (44); (29), (32), (38); (29), (35), (41); (32), (35), (44); (38), (41), (44); (3), (6), (18); (3), (9), (21); (3), (12), (24); (3), (15), (27); (6), (9), (30); (6), (12), (33); (6), (15), (36); (9), (12), (36); (9), (15), (42); (12), (15), (45); (18), (21), (30); (18), (24), (33); (18), (27), (36); (21), (24), (39); (21), (27), (42); (24), (27), (45); (30), (33), (39); (30), (36), (42); (33), (36), (45); (39), (42), (45).

These 75 sets expressed in the symbolization of the 28 equations give but 49 sets as follows:

1, 1, 1; 2, 3, 4; 2, 5, 6; 7, 8, 9; 10, 11, 12; 6, 13, 3; 14, 15, 16; 17, 18, 19; 20, 21, 22; 23, 24, 25; 26, 27, 28; 1, 2, 2; 1, 5, 5; 1, 7, 7; 1, 10, 10; 1, 6, 6; 2, 7, 14; 2, 10, 17; 5, 7, 20; 5, 10, 23; 7, 10, 26; 6, 14, 20; 6, 17, 23; 14, 17, 26; 20, 23, 26; 1, 3, 3; 1, 8, 8; 1, 11, 11; 3, 8, 15; 3, 11, 18; 6, 8, 21; 6, 11, 24; 8, 11, 27; 13, 15, 21; 13, 18, 24; 15, 18, 27; 21, 24, 27; 1, 4, 4; 1, 9, 9; 1, 12, 12; 4, 9, 16; 4, 12, 19; 2, 9, 22; 2, 12, 25; 9, 12, 28; 3, 16, 22; 3, 19, 25; 16, 19, 28; 22, 25, 28.

Since eq. 1 is an identity and eq. 5 gives, at once, $h^2 = a^2 + b^2$, there are remaining 26 equations involving the 4 unknowns x , y , z and v , and

proofs may be possible from sets of equations involving x and y , x and z , x and v , y and z , y and v , z and v , x , y and z , x , y and v , x , z and v , y , z and v , and x , y , z and v .

1st.--Proofs From Sets Involving Two Unknowns

a. The two unknowns, x and y , occur in the following five equations, viz., 2, 3, 4, 6 and 13, from which but one set of two, viz., 2 and 6, will give $h^2 + a^2 = b^2$, and as eq. 2 may be derived from 4 different proportions and equation 6 from 3 different proportions, the no. of proofs from this set are 12.

Arranged in sets of three we get,

- $2^4, 3^3, 13$ giving 12 other proofs;
- (2, 3, 4) a dependent set--no proof;
- $2^4, 4^2, 13$ giving 8 other proofs;
- (3, 6, 13) a dependent set--no proof;
- $3^3, 4^2, 6^3$ giving 18 other proofs;
- $4^2, 6^3, 13$ giving 6 other proofs;
- $3^3, 4^2, 13$ giving 6 other proofs.

Therefore there are 62 proofs from sets involving x and y .

b. Similarly, from sets involving x and z there are 8 proofs, the equations for which are 4, 7, 11, and 20.

c. Sets involving x and v give no additional proofs.

d. Sets involving y and z give 2 proofs, but the equations were used in a and b, hence cannot be counted again, they are 7, 13 and 20.

e. Sets involving y and v give no proofs.

f. Sets involving z and v give same results as d.

Therefore the no. of proofs from sets involving two unknowns is 70, making, in all 72 proofs so far, since $h^2 = a^2 + b^2$ is obtained directly from two different prop's.

2nd.--Proofs From Sets Involving Three Unknowns

a. The three unknowns x , y and z occur in the following 11 equations, viz., 2, 3, 4, 6, 7, 11, 13, 14, 18, 20 and 24, and from these 11 equations sets of four can be selected in $\frac{11 \cdot 10 \cdot 9 \cdot 8}{4} = 330$ ways, each of which will give one or more proofs for $h^2 = a^2 + b^2$. But as the 330 sets, of four equations each, include certain sub-sets heretofore used, certain dependent sets of three equations each found among those in the above 75 sets, and certain sets of four dependent equations, all these must be determined and rejected; the proofs from the remaining sets will be proofs additional to the 72 already determined.

Now, of 11 consecutive things arranged in sets of 4 each, any *one* will occur in $\frac{10 \cdot 9 \cdot 8}{3}$ or 120 of the 330 sets, any *two* in $\frac{9 \cdot 8}{2}$ or 36 of the 330, and any *three* in $\frac{8}{1}$, or 8 of the 330 sets. Therefore any sub-set of two equations will be found in 36, and any of three equations in 8, of the 330 sets.

But some one or more of the 8 may be some one or more of the 36 sets; hence a sub-set of two and a sub-set of three will not necessarily cause a rejection of $36 + 8 = 44$ of the 330 sets.

The sub-sets which gave the 70 proofs are:

- 2, 6, for which 36 sets must be rejected;
 - 7, 20, for which 35 sets must be rejected, since 7, 20, is found in *one* of the 36 sets above;
 - 2, 3, 13, for which 7 other sets must be rejected, since
 - 2, 3, 13, is found in *one* of the 36 sets above;
 - 2, 4, 13, for which 6 other sets must be rejected;
 - 3, 4, 6, for which 7 other sets must be rejected;
 - 4, 6, 13, for which 6 other sets must be rejected;
 - 3, 4, 13, for which 6 other sets must be rejected;
 - 4, 7, 11, for which 7 other sets must be rejected;
- and

4, 11, 20, for which 7 other sets must be rejected;
for all of which 117 sets must be rejected.

Similarly the dependent sets of three, which are 2, 3, 4; 3, 6, 13; 2, 7, 14; 6, 14, 20; 3, 11, 18; 6, 11, 24; and 13, 18, 24; cause a rejection of $6 + 6 + 6 + 6 + 8 + 7 + 8$, or 47 more sets.

Also the dependent sets of four, and not already rejected, which are, 2, 4, 11, 18; 3, 4, 7, 14; 3, 6, 18, 24; 3, 13, 14, 20; 3, 11, 13, 24; 6, 11, 13, 18; and 11, 14, 20, 24, cause a rejection of 7 more sets. The dependent sets of *fours* are discovered as follows: take any two dependent sets of threes having a common term as 2, 3, 4, and 3, 11, 18; drop the common term 3, and write the set 2, 4, 11, 18; a little study will disclose the 7 sets named, as well as other sets already rejected; e.g., 2, 4, 6, 13. Rejecting the $117 + 49 + 7 = 171$ sets there remain 159 sets, each of which will give one or more proofs, determined as follows. Write down the 330 sets, a thing easily done, strike out the 171 sets which must be rejected, and, taking the remaining sets one by one, determine how many proofs each will give; e.g., take the set 2, 3, 7, 11; write it thus $2^4, 3^3, 7^2, 11^2$, the exponents denoting the different proportions from which the respective equations may be derived; the product of the exponents, $4 \times 3 \times 2 \times 2 = 48$, is the number of proofs possible for that set. The set $6^3, 11^2, 18^1, 20^1$ gives 6 proofs, the set $14^1, 18^1, 20^1, 24^1$ gives but 1 proof; etc.

The 159 sets, by investigation, give 1231 proofs.

b. The three unknowns x, y and v occur in the following twelve equations, --2, 3, 4, 6, 8, 10, 11, 13, 15, 17, 21 and 23, which give 495 different sets of 4 equations each, many of which must be rejected for same reasons as in *a*. Having established a method in *a*, we leave details to the one interested.

c. Similarly for proofs from the eight equations containing x, z and v , and the seven eq's containing y, z and v .

3rd.--Proofs From Sets Involving the Four Unknowns x, y, z and v .

a. The four unknowns occur in 26 equations; hence there are $\frac{26 \cdot 25 \cdot 24 \cdot 23 \cdot 22}{5} = 65780$ different sets of 5 equations each. Rejecting all sets containing sets heretofore used and also all remaining sets of five dependent equations of which 2, 3, 9, 19, 28, is a type, the remaining sets will give us many additional proofs, the determination of which involves a vast amount of time and labor if the method given in the preceding pages is followed. If there be a shorter method, I am unable, as yet, to discover it; neither am I able to find anything by any other investigator.

4th.--Special Solutions

a. By an inspection of the 45 simple proportions given above, it is found that certain proportions are worthy of special consideration as they give equations from which very simple solutions follow.

From proportions (7) and (19) $h^2 = a^2 + b^2$ follows immediately. Also from the pairs (4) and (18), and (10) and (37), solutions are readily obtained.

b. Hoffmann's solution.

Joh. Jos. Ign. Hoffmann made a collection of 32 proofs, publishing the same in "Der Pythagoraische Lehrsatz," 2nd edition Mainz, 1821, of which the solution from (7) is one. He selects the two triangles, (see fig. 8), AHD and BCE, from which $b : (h + a)/2 = h - a : b/2$ follows, giving at once $h^2 = a^2 + b^2$.

See Jury Wipper's 46 proofs, 1880, p. 40, fig. 41. Also see Versluys, p. 87, fig. 98, credited to Hoffmann, 1818. Also see Math. Mo., Vol. II, No. II, p. 45, as given in Notes and Queries, Vol. 5, No. 43, p. 41.

c. Similarly from the two triangles BCE and ECD $b/2 : (h + a)/2 = (h - a)/2 : b/2$, $h^2 = a^2 + b^2$.

Also from the three triangles AHD, BEA and BCE proportions (4) and (8) follow, and from the three triangles AHD, BHE and BCE proportions (10) and (37) give at once $h^2 = a^2 + b^2$.

See Am. Math. Mo., V. III, pp. 169-70.

Nine

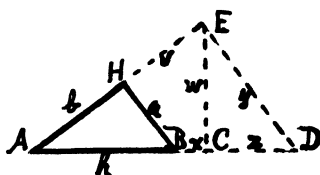


Fig. 9

Produce AB to any pt. D. From D draw DE perp. to AH produced, and from E drop the perp. EC, thus forming the 4 similar rt. tri's ABH, AED, ECD and ACE.

From the homologous sides of these similar triangles the following continued proportion results:

$$\begin{aligned} (AH = b) & : (AE = b + v) : (EC = w) : (AC = h + x) \\ & = (BH = a) : (DE = y) : (CD = z) : (EC = w) \\ & = (AB = h) : (AD = h + x + z) : (DE = y) : (AE = b + v). \end{aligned}$$

Note--B and C do not coincide.

a. From this continued prop'n 18 simple proportions are possible, giving, as in fig. 6, several thousand proofs.

b. See Am. Math. Mo., V. III, p. 171.

Ten



Fig. 10

In fig. 10 are three similar rt. tri's, ABH, EAC and DEF, from which the continued proportion

$$\begin{aligned} (HA = b) & : (AC = h + v) \\ & : (DF = DC = x) \\ & = (HB = a) : (CE = y) \\ & : (FE = z) = (AB = h) \\ & : (AE = h + v + z) : (DE = y - x) \end{aligned}$$

follows giving 9 simple proportions from which many more proofs for $h^2 = a^2 + b^2$ may be obtained.

a. See Am. Math. Mo., V. III, p. 171.

Eleven

From D in HH, so that DH = DC, draw DC par. to HB and DE perp. to AB, forming the 4 similar rt. tri's ABH, ACD, CDE and DAE, from which the continued proportion

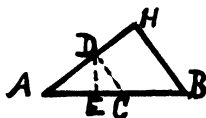


Fig. 11

$$\begin{aligned} (BH = a) : (CD = DH = v) : (EC = y) \\ : (DE = x) = (HA = b) : (DA = b - v) \\ : (DE = x) : (AE = z) = (AB = h) \\ : (AC = z + y) : (CD = v) : (AD = b - v) \end{aligned}$$

follows; 18 simple proportions are possible from which many more proofs for $h^2 = a^2 + b^2$ result.

By an inspection of the 18 proportions it is evident that they give no simple equations from which easy solutions follow, as was found in the investigation of fig. 8, as in *a* under proof *Eight*.

a. See Am. Math. Mo., V. III, p. 171.

Twelve

The construction of fig. 12 gives five similar rt. triangles, which are: ABH, AHD, HBD, ACB and BCH, from which the continued prop'n

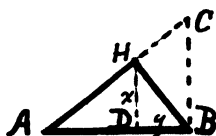


Fig. 12

$$\begin{aligned} (BH = a) : (HD = x) : (BD = y) \\ : (CB = \frac{a^2}{x}) : (CH = \frac{ay}{x}) = (HA = b) \\ : (DA = h - y) : (DH = x) : (BA = h) : (HB = a) \\ = (AB = h) : (AH = b) : (HB = a) : (AC = b + \frac{ay}{x}) \\ : (BC = \frac{a^2}{x}) \end{aligned}$$

follows, giving 30 simple proportions from which only 12 different equations result. From these 12 equations several proofs for $h^2 = a^2 + b^2$ are obtainable.

a. In fig. 9, when C falls on B it is obvious that the graph become that of fig. 12. Therefore the solution of fig. 12, is only a particular case of fig. 9; also note that several of the proofs of case 12 are identical with those of case 1, proof One.

b. The above is an original method of proof by the author of this work.

Thirteen

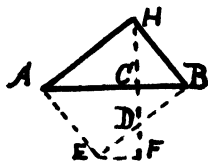


Fig. 13

Complete the paral. and draw HF perp. to, and EF par. with AB resp'ly, forming the 6 similar tri's, BHA, HCA, BCH, AEB, DCB and DFE, from which 45 simple proportions are obtainable, resulting in several thousand more possible proof for $h^2 = a^2 + b^2$, only one of which we mention.

(1) From tri's DBH and BHA,

$$DB : (BH = a) = (BH = a) : (HA = b); \therefore DB = \frac{a^2}{b}$$

$$\text{and (2) } HD : (AB = h) = (BH = a) : (HA = b);$$

$$\therefore HD = \frac{ah}{b} .$$

(3) From tri's DFE and BHA,

$$DF : (EB - DB) = (BH = a) : (AB = h),$$

$$\text{or } DF : b^2 - \frac{a^2}{b} : a : h; \therefore DF = a \left(\frac{b^2 - a^2}{bh} \right) .$$

$$(4) \text{ Tri. } ABH = \frac{1}{2} \text{ par. } HE = \frac{1}{2} AB \times HC = \frac{1}{2} ab$$

$$= \frac{1}{2} \left[AB \left(\frac{AC + CF}{2} \right) \right] = \frac{1}{2} \left[AB \left(\frac{HD + DF}{2} \right) \right]$$

$$= \frac{1}{4} \left[h \left(\frac{ah}{b} + \left(a \frac{b^2 - a^2}{bh} \right) \right) \right]$$

$$= \frac{ah^2}{4b} + \frac{ab}{4} - \frac{a^3}{4b} \therefore (5) \frac{1}{2} ab = \frac{ah^2 + ab^2 - a^3}{4b} ,$$

whence (6) $h^2 = a^2 + b^2$.

a. This particular proof was produced by Prof. D. A. Lehman, Prof. of Math. at Baldwin University, Berea, O., Dec. 1899.

b. Also see Am. Math. Mo., V. VII, No. 10, p. 228.

Fourteen



Fig. 14

Take AC and AD = AH and draw HC and HD.

Proof. Tri's CAH and HAD are isosceles. Angle CHD is a rt. angle, since A is equidistant from C, D and H.

Angle HDB = angle CHD + angle DCH.

= angle AHD + 2 angle CHA = angle CHB.

\therefore tri's HDB and CHB are similar, having angle DBH in common and angle DHB = angle ACH.

\therefore CB : BH = BH : DB, or $h + b : a = a : h - b$.

Whence $h^2 = a^2 + b^2$.

a. See Math. Teacher, Dec., 1925. Credited to Alvin Knoer, a Milwaukee High School pupil; also Versluys, p. 85, fig. 95; also Encyclopadie der Elementar Mathematik, von H. Weber und J. Wellstein, Vol. II, p. 242, where, (1905), it is credited to C. G. Sterkenburg.

Fifteen



Fig. 15

In fig. 15 the const's is obvious giving four similar right triangles ABH, AHE, HBE and HCD, from which the continued proportion

(BH = a) : (HE = x) : (BE = y)
 : (CD = y/2) = (HA = b) : (EA = h - y)
 : (EH = x) : (DH = x/2) = (AB = h)
 : (AH = b) : (HB = a) : (HC = a/2)

follows, giving 18 simple proportions.

a. From the two simple proportions

(1) $a : y = h : a$ and

(2) $b : h - y = h : b$ we get easily $h^2 = a^2 + b^2$.

b. This solution is original with the author, but, like cases 11 and 12, it is subordinate to case 1.

c. As the number of ways in which three or more similar right triangles may be constructed so as to contain related linear relations with but few unknowns involved is unlimited, so the number of possible proofs therefrom must be unlimited.

Sixteen

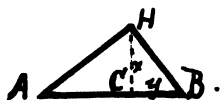


Fig. 16

The two following proofs, differing so much, in method, from those preceding, are certainly worthy of a place among selected proofs.

1st.--This proof rests on the axiom, "The whole is equal to the sum of its parts."

Let $AB = h$, $BH = a$ and $HA = b$, in the rt. tri. ABH , and let HC , C being the pt. where the perp. from H intersects the line AB , be perp. to AB . Suppose $h^2 = a^2 + b^2$. If $h^2 = a^2 + b^2$, then $a^2 = x^2 + y^2$ and $b^2 = x^2 + (h - y)^2$, or $h^2 = x^2 + y^2 + x^2 + (h - y)^2 = y^2 + 2x^2 + (h - y)^2 = y^2 + 2y(h - y) + (h - y)^2 = y + [(h - y)]^2$

$\therefore h = y + (h - y)$, i.e., $AB = BC + CA$, which is true.

\therefore the supposition is true, or $h^2 = a^2 + b^2$.

a. This proof is one of Joh. Hoffmann's 32 proofs. See Jury Wipper, 1880, p. 38, fig. 37

2nd.--This proof is the "Reductio ad Absurdum" proof.

$h^2 <, =, \text{ or } > (a^2 + b^2)$. Suppose it is less.

Then, since $h^2 = [(h - y) + y]^2 + [(h - y) + x]^2 + (h - y)^2$ and $b^2 = [ax + (h - y)]^2$, then
 $[(h - y) + x]^2 + (h - y)^2 < [ax + (h - y)]^2 + a^2$.

$$\therefore [x^2 + (h - y)^2]^2 < a^2[x^2 + (h - y)^2].$$

$\therefore a^2 > x^2 + (h - y)^2$, which is absurd. For, if the supposition be true, we must have $a^2 < x^2 + (h - y)^2$, as is easily shown.

Similarly, the supposition that $h^2 > a^2 + b^2$, will be proven false.

Therefore it follows that $h^2 = a^2 + b^2$.

a. See Am. Math. Mo., V. III, p. 170.

Seventeen



Fig. 17

Take $AE = 1$, and draw EF perp. to AH , and HC perp. to AB .

$$\begin{aligned} HC &= (AC \times FE)/FE, \quad BC = (HC \times FE)/AF \\ &= (AC \times FE)/AF \times FE/AF = AC \times FE^2/AF^2, \\ \text{and } AB &= AC \times CB = AC + AC \times FE^2/AF^2 \\ &= AC(1 + FE^2)/AF^2 = AC(AF^2 + FE^2)/AF^2. \end{aligned} \quad (1)$$

But $AB : AH = 1 : AF$, whence $AB = AH/AF$, and $AH = AC/AF$. Hence $AB = AC/AF^2$. (2)

$$\therefore AC(AF^2 + FE^2)/AF^2 = AC/AF^2. \quad \therefore AF^2 + FE^2 = 1.$$

$$\therefore AB : 1 = AH : AF. \quad \therefore AH = AB \times AF. \quad (3)$$

$$\text{and } BH = AB \times FE. \quad (4)$$

$$(3)^2 + (4)^2 = (5)^2, \text{ or, } AH^2 + BH^2 = AB^2 \times AF^2 + AB^2 \times FE^2 = AB^2(AF^2 + FE^2) = AB^2. \quad \therefore AB^2 = HB^2 + HA^2, \text{ or } h^2 = a^2 + b^2.$$

a. See Math. Mo., (1859), Vol. II, No. 2, Dem. 23, fig. 3.

b. An indirect proof follows. It is:

If $AB^2 \neq (HB^2 + HA^2)$, let $x^2 = HB^2 + HA^2$ then
 $x = (HB^2 + HA^2)^{1/2} = HA(1 + HB^2/HA^2)^{1/2} = HA(1 + FE^2/FA^2)^{1/2} = HA[(FA^2 + FE^2)/FA^2]^{1/2} = HA/FA = AB$, since $AB : AH = 1 : AF$.

\therefore if $x = AB$, $x^2 = AB^2 = HB^2 + HA^2$. Q.E.D.

c. See said Math. Mo., (1859), Vol. II, No. 2, Dem. 24, fig. 3.

Eighteen

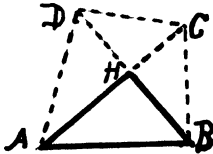


Fig. 18

From sim. tri's ABC and BCH, $HC = a^2/b$. Angle ABC = angle CDA = rt. angle. From sim. tri's AHD and DHC, $CD = ah/b$; $CB = CD$. Area of tri. ABC on base AC = $\frac{1}{2}(b + a^2/b)a$. Area of ACD on base AD = $\frac{1}{2}(ah/b)h$.

$$\therefore (b + a^2/b)a = ah^2/b = (b^2 + a^2)/b$$

$$\times a = \frac{ab^2 + a^3}{b}.$$

$$\therefore h^2 = a^2 + b^2.$$

a. See Versluys, p. 72, fig. 79.

Nineteen

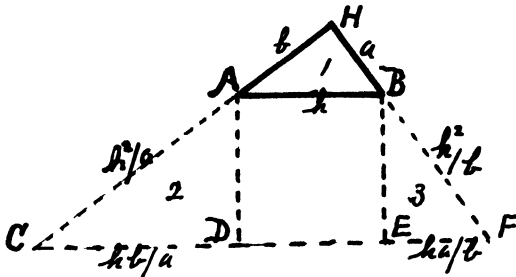


Fig. 19

Tri's 1, 2 and 3 are similar. From tri's 1 and 2, $AC = h^2/a$, and $CD = hb/a$. From tri's 1 and 3, $EF = ha/b$, and $FB = h^2/b$.

Tri. CFH = tri. 1 + tri. 2 + tri. 3 + sq. AE.

$$\text{So } \frac{1}{2}(a + h^2/b)(b + h^2/a) = \frac{1}{2}ab + \frac{1}{2}h^2(b/a) + \frac{1}{2}h^2(a/b) + h^2,$$

$$\text{or } a^2b^2 + 2abh^2 + h^4 = a^2b^2 + h^2a + h^2b + 2abh^2,$$

$$\text{or } h^4 = h^2a^2 + h^2b^2. \therefore h^2 = a^2 + b^2. \text{ Q.E.D.}$$

a. See Versluys, p. 23, fig. 80.

Twenty

Draw HC perp. to AB and = AB. Join CB and CA. Draw CD and CE perp. resp'y to HB and HA.

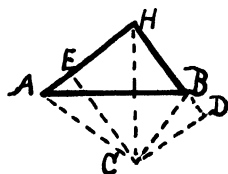


Fig. 20

Area BHAC = area ABH
 + area ABC = $\frac{1}{2}h^2$. But area tri.
 CBH = $\frac{1}{2}a^2$, and of tri. CHA = $\frac{1}{2}b^2$.
 $\therefore \frac{1}{2}h^2 = \frac{1}{2}a^2 + \frac{1}{2}b^2$. $\therefore h^2 = a^2 + b^2$.

a. See Versluys, p. 75,
 fig. 82, where credited to P. Armand
 Meyer, 1876.

Twenty-One

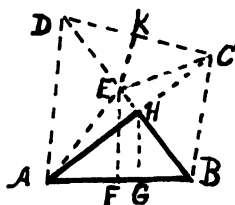


Fig. 21

HC = HB = DE; HD = HA. Join
 EA and EC. Draw EF and HG perp.
 to AB and EK perp. to DC.

Area of trap. ABCD = area
 (ABH + HBC + CHD + AHD) = $ab + \frac{1}{2}a^2$
 + $\frac{1}{2}b^2$. (1)

= area (EDA + EBC + ABE + CDE)
 = $\frac{1}{2}ab + \frac{1}{2}ab + (\frac{1}{2}AB \times EF = \frac{1}{2}AB \times AG$
 as tri's BEF and HAG are congruent)

= $ab + \frac{1}{2}(AB = CD)(AG + GB) = ab + \frac{1}{2}h^2$. (2)

$\therefore ab + \frac{1}{2}h^2 = ab + \frac{1}{2}a^2 + \frac{1}{2}b^2$. $\therefore h^2 = a^2 + b^2$. Q.E.D.

a. See Versluys, p. 74, fig. 81.

Twenty-Two

In fig. 22, it is obvious
 that:

(1) Tri. ECD = $\frac{1}{2}h^2$, (2) Tri. DBE
 = $\frac{1}{2}a^2$. (3) Tri. HAC = $\frac{1}{2}b^2$.
 $\therefore (1) = (2) + (3) = (4) \frac{1}{2}h^2 = \frac{1}{2}a^2$
 + $\frac{1}{2}b^2$. $\therefore h^2 = a^2 + b^2$. Q.E.D.

a. See Versluys, p. 76, fig.
 83, credited to Meyer, (1876); also
 this work, p. 181, fig. 238 for a
 similar geometric proof.

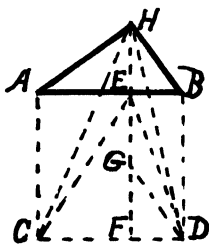


Fig. 22

Twenty-Three

For figure, use fig. 22 above, omitting lines EC and ED. Area of sq. AD = (2 area of tri. DBH = rect. BF) + (2 area of tri. HAC = rect. AF)
 $= 2 \times \frac{1}{2}a^2 + 2 \times \frac{1}{2}b^2 = a^2 + b^2 = h^2. \therefore h^2 = a^2 + b^2.$
 Or use similar parts of fig. 315, in geometric proofs.

a. See Versluys, p. 76, proof 66, credited to Meyer's, 1876, collection.

Twenty-Four

In fig. 22, denote HE by x. Area of tri. ABH + area of sq. AD = $\frac{1}{2}hx + h^2 =$ area of (tri. ACH + tri. CDH + tri. DBH) = $\frac{1}{2}b^2 + \frac{1}{2}h(h + x) + \frac{1}{2}a^2 = \frac{1}{2}b^2 + \frac{1}{2}h^2 + \frac{1}{2}hx + \frac{1}{2}a^2. \therefore h^2 = a^2 + b^2.$

a. See Versluys, p. 76, proof 67, and there credited to P. Armand Meyer's collection made in 1876.

b. Proofs Twenty-Two, Twenty-Three and Twenty-Four are only variations of the Mean Proportional Principle,--see p. 51, this book.

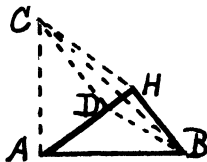
Twenty-Five

Fig. 23

At A erect AC = to, and perp. to AB; and from C drop (CD = AH) perp. to AB. Join CH, CB and DB. Then AD = HB = a. Tri. CDB = tri. CDH = $\frac{1}{2}CD \times DH.$

Tri. CAB = tri. CAD + tri. DAB + (tri. BDC = tri. CDH = tri. CAH + tri. DAB). $\therefore \frac{1}{2}h^2 = \frac{1}{2}a^2 + \frac{1}{2}b^2. \therefore h^2 = a^2 + b^2.$

a. See Versluys, p. 77, fig. 84, one of Meyer's, 1876, collection.

Twenty-Six

From A draw AC perp. to, and = to AB. Join CB, and draw BF parallel and = to HA, and CD parallel to AH and = to HB. Join CF and BD.

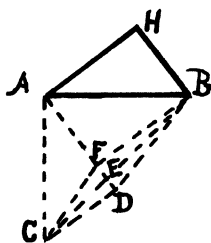


Fig. 24

Tri. CBA = tri. BAF + tri.
 FAC + tri. CBF = tri. BAF + tri. FAC
 + tri. FDB (since tri. ECF = tri.
 EDB) = tri. FAC + tri. ADB. $\therefore \frac{1}{2}h^2$
 $= \frac{1}{2}a^2 + \frac{1}{2}b^2$. $\therefore h^2 = a^2 + b^2$.

a. See Versluys, p. 77, fig. 85, being one of Meyer's collection.

Twenty-Seven

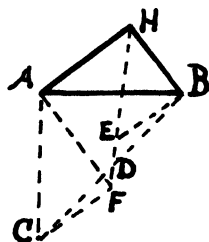


Fig. 25

From A draw AC perp. to,
 and = to AB. From C draw CF equal
 to HB and parallel to AH. Join CB,
 AF and HF and draw BE parallel to
 HA. CF = EB = BH = a. ACF and ABH
 are congruent; so are CFD and BED.

Quad. BHAC = tri. BAC + tri.
 ABH = tri. EBH + tri. HFA + tri. ACF
 + tri. FCD + tri. DBE. $\therefore \frac{1}{2}h^2 + \frac{1}{2}ab$
 $= \frac{1}{2}a^2 + \frac{1}{2}b^2 + \frac{1}{2}ab$. $\therefore h^2 = a^2 + b^2$.
 Q.E.D.

a. See Versluys, p. 78, fig. 86; also see "Vriend de Wiskunde," 1898, by F. J. Vaes.

Twenty-Eight

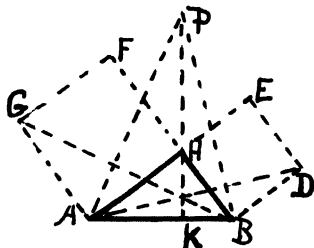


Fig. 26

Draw PHK perp. to AB
 and make PH = AB. Join PA,
 PB, AD and GB.

Tri's BDA and BHP are
 congruent; so are tri's GAB
 and AHP. Quad. AHBP = tri.
 BHP + tri. AHP. $\therefore \frac{1}{2}h^2 = \frac{1}{2}a^2$
 $+ \frac{1}{2}b^2$. $\therefore h^2 = a^2 + b^2$. Q.E.D.

a. See Versluys, p. 79,
 fig. 88. Also the Scientifique
 Revue, Feb. 16, 1889, H. Renan;

also Fourrey, p. 77 and p. 99,--Jal de Vuibert, 1879-80.

Twenty-Nine

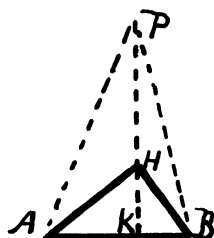


Fig. 27

Through H draw PK perp. to AB, making PH = AH, and join PA and PB.

Since area AHBP = [area PHA + area PHB = $\frac{1}{2}h \times AK + \frac{1}{2}h \times BK$ = $\frac{1}{2}h(AK + BK) = \frac{1}{2}h \times h = \frac{1}{2}h^2$] = (area AHP + area BHP = $\frac{1}{2}b^2 + \frac{1}{2}a^2$). $\therefore \frac{1}{2}h^2 = \frac{1}{2}a^2 + \frac{1}{2}b^2$. $\therefore h^2 = a^2 + b^2$.

a. See Versluys, p. 79, fig. 89, being one of Meyer's, 1876, collection.

Thirty

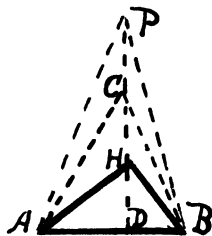


Fig. 28

Draw PH perp. to AB, making PH = CD = AB. Join PA, PB, CA and CB.

Tri. ABC = (tri. ABH + quad. AHBC) = (quad. AHBC + quad. ACBP), since PC = HD. In tri. BHP, angle BHP = $180^\circ - (\text{angle BHD} = 90^\circ + \text{angle HBD})$. So the alt. of tri. BHP from the vertex P = a, and its area = $\frac{1}{2}a^2$; likewise tri. AHP = $\frac{1}{2}b^2$. But as in fig. 27 above, area AHBP = $\frac{1}{2}h^2$. $\therefore h^2 = a^2 + b^2$. Q.E.D.

a. See Versluys, p. 80, fig. 90, as one of Meyer's, 1876, collections.

Thirty-One

Tri's ABH and BDH are similar, so $DH = a^2/b$ and $DB = ab/h$. Tri. ACD = 2 tri. ABH + 2 tri. DBH.

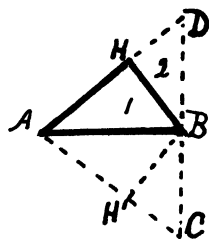


Fig. 29

Area of tri. ACD = ah^2/b
 = area of 2 tri. ABH + 2 tri. DBH
 = $ab + a^3/b$. $\therefore h^2 = a^2 + b^2$. Q.E.D.
 a. See Versluys, p. 87, fig.

91.

Thirty-Two

Fig. 30

Another Reductio ad Absurdum proof--see proof Sixteen above.

Suppose $a^2 + b^2 > h^2$. Then
 $AC^2 + p^2 > b^2$, and $CB^2 + p^2 > a^2$.
 $\therefore AC^2 + CB^2 + 2p^2 > a^2 + b^2 > h^2$. As
 $2p^2 = 2(AC \times BC)$ then $AC^2 + CB^2 + 2AC$
 $\times CB > a^2 + b^2$, or $(AC + CB)^2 > a^2$
 $+ b^2 > h^2$ or $h^2 > a^2 + b^2 > h^2$, or $h^2 > h^2$, an ab-
 surdity. Similarly, if $a^2 + b^2 < h^2$. $\therefore h^2 = a^2 + b^2$.
 Q.E.D.

a. See Versluys, p. 60, fig. 64.

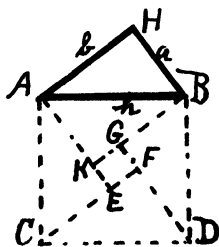
Thirty-Three

Fig. 31

Sq. AD = (area of 4 tri's
 = 4 \times tri. ABH + area of sq. KF)
 = $4 \times \frac{1}{2}ab + (b - a)^2 = 2ab + b^2$
 - $2ab + a^2 = a^2 + b^2$. $\therefore h^2 = a^2 + b^2$.

a. See Math. Mo., 1858-9,
 Vol. I, p. 361, and it refers to
 this proof as given by Dr. Hutton,
 (Tracts, London, 1812, 3 Vol., 800)
 in his History of Algebra.

Thirty-four

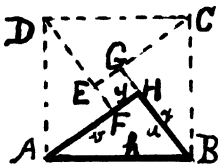


Fig. 32

Let $BH = x$, and $HF = y$;
 then $AH = x + y$; sq. $AC = 4$ tri.
 $ABH + \text{sq. HE} = 4 \left[\frac{x(x+y)}{2} \right] + y^2$
 $= 2x^2 + 2xy + y^2 = x^2 + 2xy + y^2$
 $+ x^2 = (x+y)^2 + x^2. \therefore \text{sq. on } AB$
 $= \text{sq. of } AH + \text{sq. of } BH. \therefore h^2$
 $= a^2 + b^2. \text{ Q.E.D.}$

a. This proof is due to
 Rev. J. G. Excell, Lakewood, O.,
 July, 1928; also given by R. A.
 Bell, Cleveland, O., Dec. 28, 1931. And it appears
 in "Der Pythagoreisch Lehrsatz" (1930), by Dr. W.
 Leitzmann, in Germany.

Thirty-five

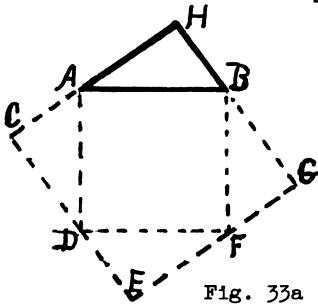


Fig. 33a

In fig. 33a, sq. CG
 $= \text{sq. AF} + 4 \times \text{tri. ABH} = h^2$
 $+ 2ab. \text{ --- (1)}$

In fig. 33b, sq. KD
 $= \text{sq. KH} + \text{sq. HD} + 4 \times \text{tri. ABH}$
 $= a^2 + b^2 + 2ab. \text{ --- (2)}$
 But sq. $CG = \text{sq. KD}$, by
 const'n. $\therefore (1) = (2)$ or h^2
 $+ 2ab = a^2 + b^2 + 2ab. \therefore h^2$
 $= a^2 + b^2. \text{ Q.E.D.}$

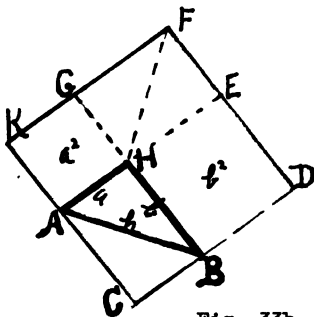


Fig. 33b

a. See Math. Mo.,
 1809, dem. 9, and there, p.
 159, Vol. I, credited to Rev.
 A. D. Wheeler, of Brunswick,
 Me.; also see Fourrey, p. 80,
 fig's a and b; also see "Der
 Pythagoreisch Lehrsatz"
 (1930), by Dr. W. Leitzmann.

b. Using fig. 33a, a
 second proof is: Place 4 rt.
 triangles BHA, ACD, DEF and
 FGB so that their legs form a

square whose side is HC. Then it is plain that:

1. Area of sq. HE = $a^2 + 2ab + b^2$.
2. Area of tri. BHA = $ab/2$.
3. Area of the 4 tri's = $2ab$.
4. Area of sq. AF = area of sq. HE - area of the 4 tri's = $a^2 + 2ab + b^2 - 2ab = a^2 + b^2$.
5. But area of sq. AF = h^2 .
6. $\therefore h^2 = a^2 + b^2$. Q.E.D.

This proof was devised by Maurice Laisnez, a high school boy, in the Junior-Senior High School of South Bend, Ind., and sent to me, May 16, 1939, by his class teacher, Wilson Thornton.

Thirty-Six

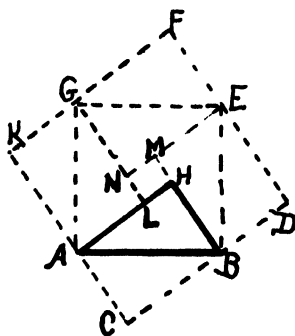


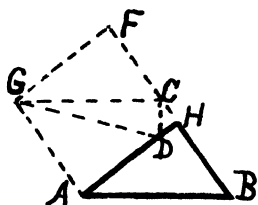
Fig. 34

$$\begin{aligned} \text{Sq. AE} &= \text{sq. KD} - 4\text{ABH} \\ &= (a + b)^2 - 2ab; \text{ and } h^2 = \text{sq.} \\ &\text{NH} + 4\text{ABH} = (b - a)^2 + 2ab. \\ \text{Adding, } 2h^2 &= (a + b)^2 \\ &+ (b - a)^2 = 2a^2 + 2b^2. \therefore h^2 \\ &= a^2 + b^2. \text{ Q.E.D.} \end{aligned}$$

a. See Versluys, p. 72, fig. 78; also given by Saunderson (1682-1750); also see Fourrey, p. 92, and A. Marre. Also assigned to Bhaskara, the Hindu Mathematician, 12th century A.D. Also said to have been known in China 1000 years before the time of Christ.

Thirty-Seven

Since tri's ABH and CDH are similar, and $CH = b - a$, then $CD = h(b - a)/b$, and $DH = a(b - a)/b$. Draw GD. Now area of tri. CDH = $\frac{1}{2}(b - a) \times a(b - a)/b = \frac{1}{2}a(b - a)^2/b$. ---(1)



$$\begin{aligned} \text{Area of tri. DGA} &= \frac{1}{2}GA \times AD = \frac{1}{2}b \\ &\times \left[b^2 - \frac{a(b-a)}{b} \right] = \frac{1}{2}[b^2 - a(b-a)] \end{aligned} \quad (2)$$

$$\begin{aligned} \text{Area of tri. GDC} &= \frac{1}{2}h\left(\frac{b-a}{b}\right)h \\ &= \frac{1}{2}h^2\left(\frac{b-a}{b}\right). \quad \text{--- (3)} \end{aligned}$$

Fig. 35

\therefore area of sq. AF = (1) + (2) + (3)
 + tri. GCF = $\frac{1}{2}a(b-a)^2/b$
 $+ \frac{1}{2}[b^2 - a(b-a)] + \frac{1}{2}h^2(b-a)/b + \frac{1}{2}ab = b^2$, which
 reduced and collected gives $h^2(b-a) - (b-a)a^2$
 $= (b-a)b^2$. $\therefore h^2 = a^2 + b^2$. Q.E.D.

a. See Versluys, p. 73-4, solution 62.

b. An Arabic work of Annairizo, 900 N.C. has a similar proof.

c. As last 5 proofs show, figures for geometric proof are figures for algebraic proofs also. Probably for each geometric proof there is an algebraic proof.

B.--The Mean Proportional Principle

The mean proportional principle leading to equivalency of areas of triangles and parallelograms, is very prolific in proofs.

By rejecting all similar right triangles other than those obtained by dropping a perpendicular from the vertex of the right angle to the hypotenuse of a right triangle and omitting all equations resulting from the three similar right triangles thus formed, save only equations (3), (5) and (7), as given in proof *One*, we will have limited our field greatly. But in this limited field the proofs possible are many, of which a few very interesting ones will now be given.

In every figure under B we will let h = the hypotenuse, a = the shorter leg, and b = the longer leg of the given right triangle ABH.

Thirty-Eight

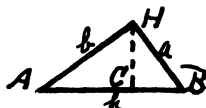


Fig. 36

Since $AC : AH = AH : AB$, $AH^2 = AC \times AB$, and $BH^2 = BC \times BA$. Then $BH^2 + HA^2 = (AC + CB)HB = AB^2$. $\therefore h^2 = a^2 + b^2$.

a. See Versluys, p. 82, fig.

92, as given by Leonardo Pisano, 1220, in *Practica Geometriae*; Wallis, Oxford, 1655; Math. Mo. 1859, Dem. 4, and credited to Legendre's *Geom.*; Wentworth's *New Plane Geom.*, p. 158 (1895); also Chauvenet's *Geom.*, 1891, p. 117, Prop. X. Also Dr. Leitzmann's work (1930), p. 33, fig. 34. Also "Mathematics for the Million," (1937), p. 155, fig. 51 (1), by Lancelot Hogben. F.R.S.

Thirty-Nine

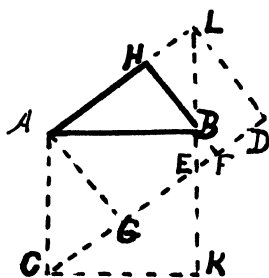


Fig. 37

Extend AH and KB to L, through C draw CD par. to AL, AG perp. to CD, and LD par. to HB, and extend HB to F.

$BH^2 = AH \times HL = FH \times HL = FDLH = a^2$. Sq. AK = paral. HCEL = paral. AGDL = $a^2 + b^2$. $\therefore h^2 = a^2 + b^2$. Q.E.D.

a. See Versluys, p. 84, fig. 94, as given by Jules Camirs, 1889 in *S. Revue*

Forty

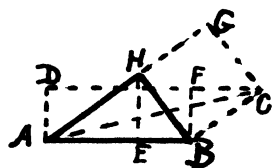


Fig. 38

Draw AC. Through C draw CD par. to BA, and the perp's AD, HE and BF.

Tri. ABC = $\frac{1}{2}$ sq. BG = $\frac{1}{2}$ rect. BD. \therefore sq. BG = a^2 = rect. BD = sq. EF + rect. ED = sq. EF + (EA \times ED = EH^2) = sq. EF + EH^2 . But tri's ABH and BHE

are similar. \therefore , if in tri. BHE, $BH^2 = BE^2 + EH^2$,
then in its similar, the tri. ABH, $AB^2 = BH^2 + HA^2$.
 $\therefore h^2 = a^2 + b^2$. Q.E.D.

a. See Sci. Am. Sup., Vol. 70, p. 382, Dec. 10, 1910, fig. 7--one of the 108 proofs of Arthur E. Colburn, LL.M., of Dist. of Columbia Bar.

Forty-One

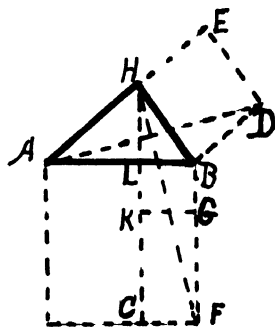


Fig. 39

Const'n obvious. Rect.
 $LF = 2 \text{ tri. FBH} + 2 \text{ tri. ADB}$
 $= \text{sq. HD} = \text{sq. LG} + (\text{rect. KF}$
 $= KC \times CF = AL \times LB = HL^2)$
 $= \text{sq. LG} + HL^2$.

But tri's ABH and BHL
 are similar. Then as in fig. 36,
 $h^2 = a^2 + b^2$.

a. See Sci. Am. Sup., V. 70, p. 359, one of Colburn's 108.

Forty-Two

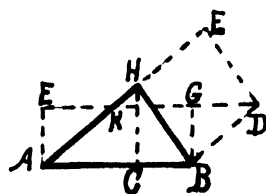


Fig. 40

Construction as in fig. 38. Paral. BDKA = rect. AG = AB \times BG = AB \times BC = BH^2 . And AB \times AC = AH^2 . Adding $BH^2 + AH^2 = AB \times BC + AB \times AC = AB(AC + CB) = AB^2$. $\therefore h^2 = a^2 + b^2$. Q.E.D.

a. See Wipper, 1880, p. 39, fig. 38 and there credited to Oscar Werner, as recorded in

"Archiv. d. Math. und Phys.," Grunert, 1855; also see Versluys, p. 64, fig. 67, and Fourrey, p. 76.

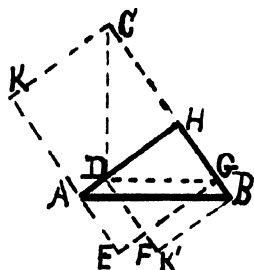
Forty-Three

Fig. 41

Two squares, one on AH const'd outwardly, the other on HB overlapping the given triangle.

Take $HD = HB$ and const't rt. tri. CDG . Then tri's CDH and ABH are equal. Draw GE par. to AB meeting GKA produced at E .

Rect. $GK = \text{rect. } GA + \text{sq. } HK = (HA = HC)HG + \text{sq. } HK = HD^2 + \text{sq. } HK$.

Now $GC : DC = DC : (HC = GE)$
 $\therefore DC^2 = GC \times GE = \text{rect. } GK = \text{sq. } HK + \text{sq. } HK$

$HK + \text{sq. } DB = AB^2. \therefore h^2 = a^2 + b^2.$

a. See Sci. Am. Sup., V. 70, p. 382, Dec. 10, 1910. Credited to A. E. Colburn.

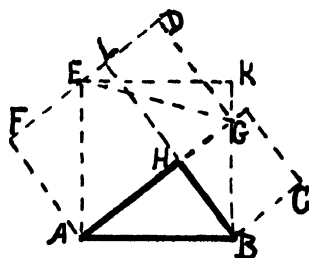
Forty-Four

Fig. 42

$AK = \text{sq. on } AB.$

Through G draw GD par. to HL and meeting FL produced at D and draw EG .

Tri. AGE is common to $\text{sq. } AK$ and $\text{rect. } AD. \therefore \text{tri. } AGE = \frac{1}{2} \text{sq. } AK = \frac{1}{2} \text{rect. } AD. \therefore \text{sq. } AK = \text{rect. } AD. \text{ Rect. } AD = \text{sq. } HF + (\text{rect. } HD = \text{sq. } HC, \text{ see argument in proof 39}). \therefore \text{sq. } BE = \text{sq. } HC + HF, \text{ or } h^2 = a^2 + b^2.$

a. See Sci. Am. Sup., V. 70, p. 382, Dec. 10, 1910. Credited to A. E. Colburn.

b. I regard this proof, wanting ratio, as a geometric, rather than an algebraic proof. E. S. Loomis.

Forty-Five

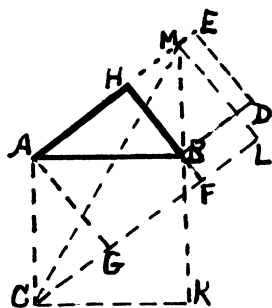


Fig. 43

$HG = \text{sq. on } AH.$ Extend
 KB to M and through M draw ML
 par. to HB meeting GF extended
 at L and draw $CM.$

Tri. $ACG = \text{tri. } ABH.$

Tri. $MAC = \frac{1}{2} \text{ rect. } AL = \frac{1}{2} \text{ sq. } AK.$
 $\therefore \text{sq. } AK = \text{rect. } AL = \text{sq. } HG +$
 $(\text{rect. } HL = ML \times MH). = HA \times HM$
 $= HB^2 = \text{sq. } HD) = \text{sq. } HG + \text{sq. } HD.$
 $\therefore h^2 = a^2 + b^2.$

a. See Am. Sci. Sup., V.
 70, p. 383, Dec. 10, 1910. Cred-
 ited to A. E. Colburn.

Forty-Six

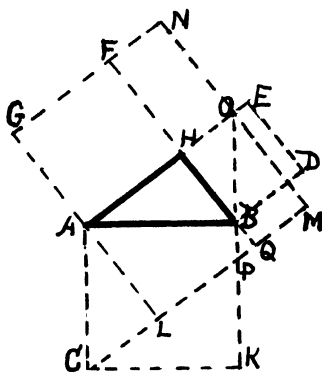


Fig. 44

Extend KB to O in $HE.$
 Through O , and par. to HB draw
 NM , making OM and ON each = to
 $HA.$ Extend GF to N , GA to L ,
 making $AL = \text{to } AG$ and draw $CM.$

Tri. $ACL = \text{tri. } OPM$
 $= \text{tri. } ABH$, and $\text{tri. } CKP$
 $= \text{tri. } ABO.$

$\therefore \text{rect. } OL = \text{sq. } AK,$
 having polygon $ALPB$ in common.
 $\therefore \text{sq. } AK = \text{rect. } AM = \text{sq. } HG$
 $+ \text{rect. } HN = \text{sq. } HG + \text{sq. } HD;$
 see proof Forty-Four above.
 $\therefore h^2 = a^2 + b^2. \text{ Q.E.D.}$

a. See Am. Sci. Sup.,
 V. 70, p. 383. Credited to
 A. E. Colburn.

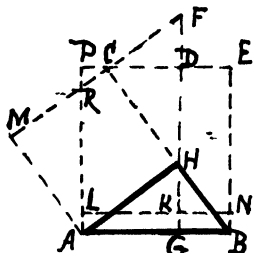
Forty-Seven

Fig. 45

$= HB^2 + \text{sq. AC}$, or $h^2 = a^2 + b^2$.

a. Original with the author of this work,
Feb. 2, 1926.

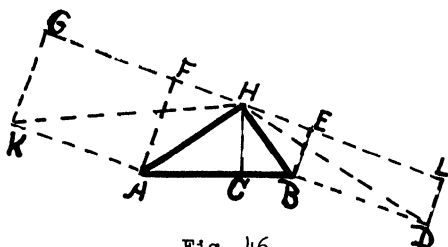
Forty-Eight

Fig. 46

Construct
tri. BHE = tri. BHC
and tri. AHF = tri.
AHC, and through pts.
F, H, and E draw the
line GHL, making FG
and EL each = AB,
and complete the
rect's FK and ED,
and draw the lines
HD and HK.

Tri. HKA
 $= \frac{1}{2} AK \times AF = \frac{1}{2} AB$
 $\times AC - \frac{1}{2} AH^2$. Tri. HBD = $\frac{1}{2} BD \times BE = \frac{1}{2} AB \times BC = \frac{1}{2}$
 HB^2 . Whence $AB \times AC = AH^2$ and $AB \times BC = HB^2$. Add-
ing, we get $AB \times AC + AB \times BC = AB(AC + BC) = AB^2$,
or $AB^2 = BH^2 + HA^2$. $\therefore h^2 = a^2 + b^2$.

a. Original with the author, discovered Jan.
31, 1926.

Forty-Nine

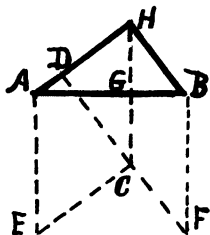


Fig. 47

Construction. Draw HC, AE and BF each perp. to AB, making each equal to AB. Draw EC and FCD. Tri's ABH and HCD are equal and similar.

$$\begin{aligned} \text{Figure FCEBHA} &= \text{paral. CB} \\ &+ \text{paral. CA} = \text{CH} \times \text{GB} + \text{CH} \times \text{GA} \\ &= \text{AB} \times \text{GB} + \text{AB} \times \text{AG} = \text{HB}^2 + \text{HA}^2 \\ &= \text{AB}(\text{GB} + \text{AG}) = \text{AB} \times \text{AB} = \text{AB}^2. \end{aligned}$$

a. See Math. Teacher, V. XVI, 1915. Credited to Geo. G. Evans, Charleston High School, Boston, Mass.; also Versluys, p. 64, fig. 68, and p. 65, fig. 69; also Journal de Matheïn, 1888, F. Fabre; and found in "De Vriend der Wirk, 1889," by A. E. B. Dulfer.

Fifty

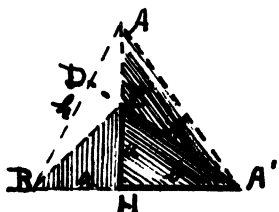


Fig. 48

I am giving this figure of Cecil Hawkins as it appears in Versluys' work,--not reducing it to my scale of $h = 1''$.

Let $\text{HB}' = \text{HB} = a$, and $\text{HA}' = \text{HA} = b$, and draw $\text{A}'\text{B}'$ to D in AB.

Then angle BDA' is a rt. angle, since tri's BHA and B'HA' are congruent having base and altitude of the one res'ly perp.

to base and altitude of the other.

$$\begin{aligned} \text{Now tri. BHB}' + \text{tri. AHA}' &= \text{tri. BA}'\text{B}' + \text{tri. AB}'\text{A}' \\ &= \text{tri. BAA}' - \text{tri. BB}'\text{A}'. \quad \therefore \frac{1}{2} a^2 + \frac{1}{2} b^2 \\ &= \frac{1}{2} (\text{AB} \times \text{A}'\text{D} - \frac{1}{2} (\text{AB} \times \text{B}'\text{D})) = \frac{1}{2} [\text{AB}(\text{A}'\text{B}' + \text{B}'\text{D})] \\ &- \frac{1}{2} (\text{AB} \times \text{B}'\text{D}) = \frac{1}{2} \text{AB} \times \text{A}'\text{B}' + \frac{1}{2} \text{AB} \times \text{B}'\text{D} - \frac{1}{2} \text{AB} \times \text{B}'\text{D} \\ &= \frac{1}{2} \text{AB} \times \text{A}'\text{B}' = \frac{1}{2} h \times h = \frac{1}{2} h^2. \quad \therefore h^2 = a^2 + b^2. \end{aligned}$$

Q.E.D.

a. See Versluys, p. 71, fig. 76, as given by Cecil Hawkins, 1909, of England.

Fifty-One

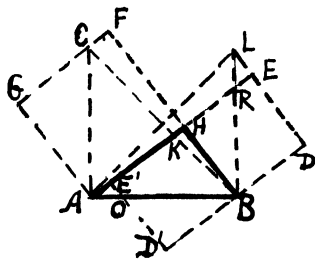


Fig. 49

$\therefore h^2 = a^2 + b^2$. Q.E.D.

Or from (1) thus: $\frac{1}{2}h^2 + \frac{1}{2}(b+a)(b-a) = b^2$
 $= \frac{1}{2}b^2 + \frac{1}{2}h - \frac{1}{2}a$. Whence $h^2 = a^2 + b^2$.

a. See Versluys, p. 67, fig. 71, as one of Meyer's collection, of 1876.

Fifty-Two

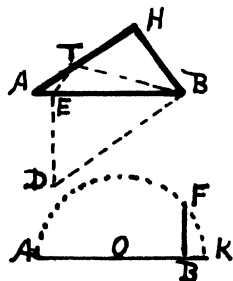


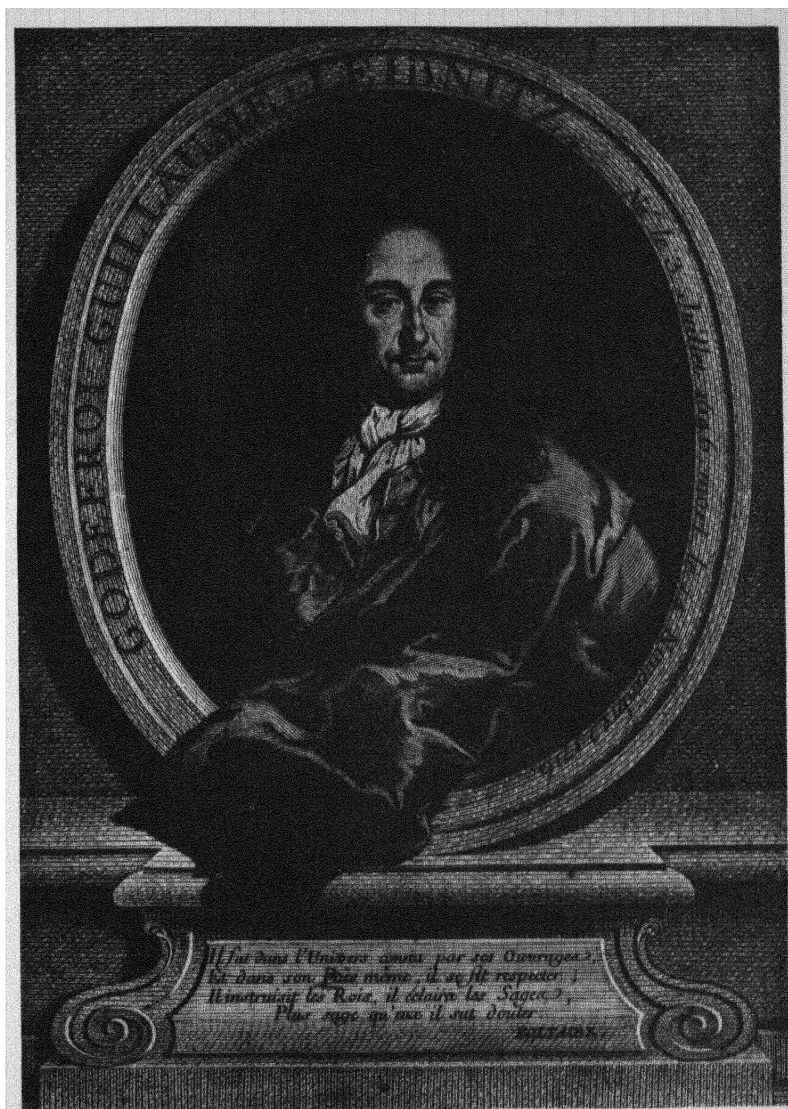
Fig. 50

Given the rt. tri. ABH.
 Through B draw $BD = 2BH$ and par. to AH. From D draw perp. DE to AB. Find mean prop'l between AB and AE which is BF. From A, on AH, lay off $AT = BF$. Draw TE and TB, forming the two similar tri's AET and ATB, from which $AT : TB = AE : AT$, or $(b-a)^2 = h(h-EB)$, whence $EB = [h - (b-a)^2]/h$. --- (1)

Also $EB : AH = BD : AB$.
 $\therefore EB = 2ab/h$. --- (2) Equating (1) and (2) gives $[h - (b-a)^2]/h = 2ab/h$, whence $h^2 = a^2 + b^2$.

a. Devised by the author, Feb. 28, 1926.

b. Here we introduce the circle in finding the mean proportional.



*Il fut dans l'Univers connu par ses Ouvrages,
Et dans son País même, il se fit respecter,
Il mérita des Rois, il éclaira les Sages,
Plus sage qu'aucun il sut douter.*

BOETIUS

GOTTFRIED WILHELM LEIBNIZ

1646-1716

Fifty-Three

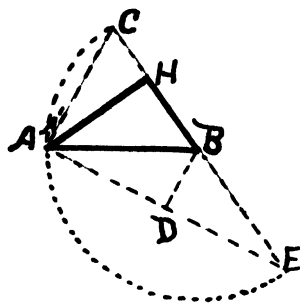


Fig. 51

An indirect algebraic proof, said to be due to the great Leibniz (1646-1716).

If (1) $HA^2 + HB^2 = AB^2$, then (2) $HA^2 = AB^2 - HB^2$, whence (3) $HA^2 = (AB + HB)(AB - HB)$.

Take BE and BC each equal to AB, and from B as center describe the semicircle CA'E. Join AE and AC, and draw BD perp. to AE. Now (4) $HE = AB + HB$, and (5) $HC = AB - HB$. (4) \times (5) gives $HE \times HC$

$= HA^2$, which is true only when triangles AHC and EHA are similar.

\therefore (6) angle CAH = angle AEH, and so (7) $HC : HA = HA : HE$; since angle HAC = angle E, then angle CAH = angle EAH. \therefore angle AEH + angle EAH = 90° and angle CAH + angle EAH = 90° . \therefore angle EAC = 90° . \therefore vertex A lies on the semicircle, or A coincides with A'. \therefore EAC is inscribed in a semicircle and is a rt. angle. Since equation (1) leads through the data derived from it to a rt. triangle, then starting with such a triangle and reversing the argument we arrive at $h^2 = a^2 + b^2$.

a. See Versluys, p. 61, fig. 65, as given by von Leibniz.

Fifty-Four

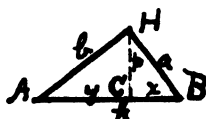


Fig. 52

$$\begin{aligned}
 &\text{Let } CB = x, CA = y \text{ and } HC \\
 &= p. \quad p^2 = xy; \quad x^2 + p^2 = x^2 + xy \\
 &= x(x + y) = a^2. \quad y^2 + p^2 = y^2 + xy \\
 &= y(x + y) = b^2. \quad x^2 + 2p^2 + y^2 \\
 &= a^2 + b^2. \quad x^2 + 2xy + y^2 = (x + y)^2 \\
 &= a^2 + b^2. \quad \therefore h^2 = a^2 + b^2. \quad \text{Q.E.D.}
 \end{aligned}$$

a. This proof was sent to me by J. Adams of The Hague, Holland. Received it March 2, 1934, but the author was not given.

Fifty-Five



Fig. 53

Assume (1) $HB^2 + HA^2 = AB^2$.
 Draw HC perp. to AB . Then (2) $AC^2 + CH^2 = HA^2$. (3) $CB^2 + CH^2 = HB^2$,
 (4) Now $AB = AC + CB$, so (5) $AB^2 = AC^2 + 2AC \times CB + CB^2 = AC^2 + 2HC^2 + CB^2$. But (6) $HC^2 = AC \times CB$. \therefore
 (7) $AB^2 = AC^2 + 2AC \times CB + CB^2$ and
 (8) $AB = AC + CB$. \therefore (9) $AB^2 = AC^2 + 2AC \times CB + CB^2$.
 (2) + (3) = (10) $HB^2 + HA^2 = AC^2 + 2HC^2 + CB^2$, or
 (11) $AB^2 = HB^2 + HA^2$. \therefore (12) $h^2 = a^2 + b^2$. Q.E.D.

a. See Versluys, p. 62, fig. 66.

b. This proof is one of Hoffmann's, 1818, collection.

C.--The Circle in Connection with the Right Triangle

(I).--Through the Use of One Circle

From certain Linear Relations of the Chord, Secant and Tangent in conjunction with a right triangle, or with similar related right triangles, it may also be proven that: *The square of the hypotenuse of a right triangle is equal to the sum of the squares of the other two sides.*

And since the algebraic is the measure or transliteration of the geometric square the truth by any proof through the algebraic method involves the truth of the geometric method.

Furthermore these proofs through the use of circle elements are true, not because of straight-line properties of the circle, but because of the law of similarity, as each proof may be reduced to the proportionality of the homologous sides of similar triangles, the circle being a factor only in this, that the homologous angles are measured by equal arcs.

(1) The Method by Chords.

Fifty-Six

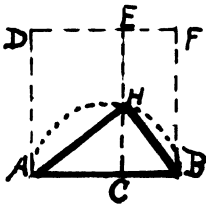


Fig. 54

H is any pt. on the semi-circle BHA. \therefore the tri. ABH is a rt. triangle. Complete the sq. AF and draw the perp. EHC.

$BH^2 = AB \times BC$ (mean proportional)

$AH^2 = AB \times AC$ (mean proportional)

Sq. AF = rect. BE + rect. AE = $AB \times BC$
 + $AB \times AC = BH^2 + AH^2$. $\therefore h^2 = a^2 + b^2$.

a. See Sci. Am. Sup., V. 70, p. 383, Dec. 10, 1910. Credited to A. E. Colburn.

b. Also by Richard A. Bell,--given to me Feb. 28, 1938. He says he produced it on Nov. 18, 1933.

Fifty-Seven

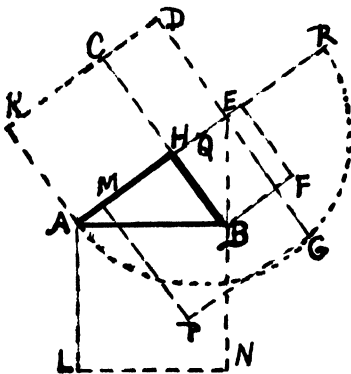


Fig. 55

Take $ER = ED$ and Bisect HE. With Q as center describe semicircle AGR. Complete sq. EP.

Rect. HD = $HC \times HE = HA \times HE = HB^2 =$ sq. HF. EG is a mean proportional between EA and ($ER = ED$).

\therefore sq. EP = rect. AD = sq. AC + sq. HF. But AB is a mean prop'l between EA and ($ER = ED$). $\therefore EG = AB$.

sq. BL = sq. AC + sq. HF. $\therefore h^2 + a^2 + b^2$.

a. See Sci. Am.

Sup., V. 70, p. 359, Dec. 3, 1910. Credited to A. E. Colburn.

Fifty-Eight

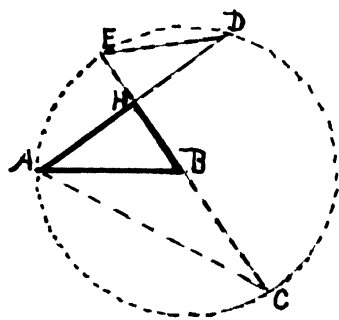


Fig. 56

In any circle upon any diameter, EC in fig. 56, take any distance from the center less than the radius, as BH. At H draw a chord AD perp. to the diameter, and join AB forming the rt. tri. ABH.

a. Now $HA \times HD = HC \times HE$, or $b^2 = (h + a)(h - a)$.
 $\therefore h^2 = a^2 + b^2$.

b. By joining A and C, and E and D, two similar rt. tri's are formed, giving $HC : HA = HD : HE$, or,

again, $b^2 = (h + a)(h - a)$. $\therefore h^2 = a^2 + b^2$.

But by joining C and D, the tri. DHC = tri. AHC, and since the tri. DEC is a particular case of *One*, fig. 1, as is obvious, the above proof is subordinate to, being but a particular case of the proof of, *One*.

c. See Edwards' Geometry, p. 156, fig. 9, and Journal of Education, 1887, V. XXV, p. 404, fig. VII.

Fifty-Nine

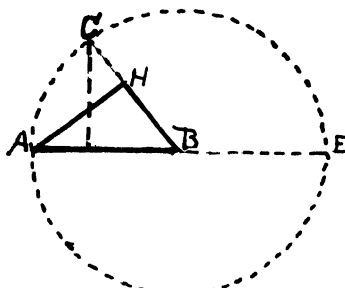


Fig. 57

With B as center, and radius = AB, describe circle AEC.

Since CD is a mean proportional between AD and DE, and as $CD = AH$, $b^2 = (h - a)(h + a) = h^2 - a^2$.
 $\therefore h^2 = a^2 + b^2$.

a. See Journal of Education, 1888, Vol. XXVII, p. 327, 21st proof; also Heath's Math. Monograph,

No. 2, p. 30, 17th of the 26 proofs there given.

b. By analysis and comparison it is obvious, by substituting for ABH its equal, tri. CBD, that above solution is subordinate to that of Fifty-Six.

Sixty

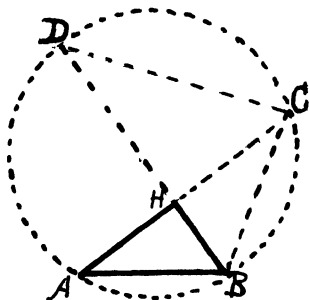


Fig. 58

In any circle draw any chord as AC perp. to any diameter as BD, and join A and B, B and C, and C and D, forming the three similar rt. tri's ABH, CBH and DBC.

Whence $AB : DB = BH : BC$, giving $AB \times BC = DB \times BH = (DH + HB)BH = DH \times BH + BH^2 = AH \times HC + BH^2$; or $h^2 = a^2 + b^2$.

a. Fig. 58 is closely related to Fig. 56.

b. For solutions see Edwards' Geom., p. 156, fig. 10, Journal of Education, 1887, V. XXVI, p. 21, fig. 14, Heath's Math. Monographs, No. 1, p. 26 and Am. Math. Mo., V. III, p. 300, solution XXI.

Sixty-One

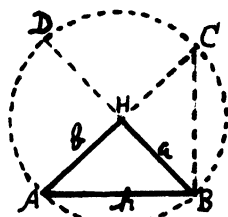


Fig. 59

Let H be the center of a circle, and AC and BD two diameters perp. to each other. Since $HA = HB$, we have the case particular, same as in fig. under Geometric Solutions.

Proof 1. $AB \times BC = BH^2 + AH \times CH. \therefore AB^2 = HB^2 + HA^2. \therefore h^2 = a^2 + b^2$.

Proof 2. $AB \times BC = BD \times HB = (BH + HD) \times BH = BH^2 + (HD \times HB = HA \times HC) = BH^2 + AH^2. \therefore h^2 = a^2 + b^2$.

a. These two proofs are from Math. Mo., 1859, Vol. 2, No. 2, Dem. 20 and Dem. 21, and are applications of Prop. XXXI, Book IV, Davies Legendre, (1858), p. 119; or Book III, p. 173, Exercise 7, Schuyler's Geom., (1876), or Book III, p. 165, Prop. XXIII, Wentworth's New Plane Geom., (1895).

b. But it does not follow that being true when $HA = HB$, it will be true when $HA >$ or $<$ HB . The author.

Sixty-Two

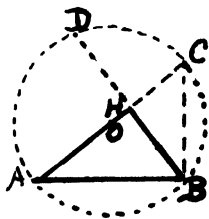


Fig. 60

At B erect a perp. to AB and prolong AH to C, and BH to D. $BH = HD$. Now $AB^2 = AH \times AC = AH(AH + HC) = AH^2 + (AH \times HC = HB^2) = AH^2 + HB^2$. $\therefore h^2 = a^2 + b^2$. Q.E.D.

a. See Versluys, p. 92, fig. 105.

Sixty-Three

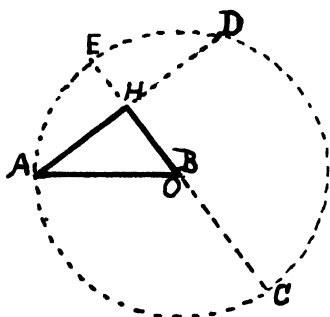


Fig. 61

From the figure it is evident that $AH \times HD = HC \times HE$, or $b^2 = (h + a)(h - a) = h^2 - a^2$. $\therefore h^2 = a^2 + b^2$. Q.E.D.

a. See Versluys, p. 92, fig. 106, and credited to Wm. W. Rupert, 1900.

Sixty-Four

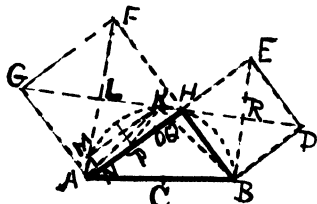


Fig. 62

With CB as radius describe semicircle BHA cutting HL at K and AL at M .
Arc $BH = \text{arc } KM$. $\therefore BN = NQ = AO = MR$ and $KB = KA$; also arc $BHK = \text{arc } AMR = MKH = 90^\circ$.
So tri's BRK and KLA are congruent. $HK = HL - KL = HA - OA$. Now $HL \div KL = HA : OA$.
So $HL - KL : HL = HA - OA : HA$, or $(HL - KL) \div HL = (HA - OA)$

$$\div HA = (b - a)/b. \therefore KQ = (HK \div NL)LP = [(b - a) \div b] \times \frac{1}{2}b = \frac{1}{2}(b - a).$$

Now tri. $KLA = \text{tri. } HLA - \text{tri. } AHK = \frac{1}{4}b^2 - \frac{1}{2}b \times \frac{1}{2}(b - a) = \frac{1}{4}ba = \frac{1}{2} \text{tri. } ABH$, or tri. $ABH = \text{tri. } BKR + \text{tri. } KLA$, whence trap. $LABR - \text{tri. } ABH = \text{trap. } LABR - (\text{tri. } BKR + \text{tri. } KLA) = \text{trap. } LABR - (\text{tri. } HBR + \text{tri. } HAL) = \text{trap. } LABR - \text{tri. } ABK$. $\therefore \text{tri. } ABK = \text{tri. } HBR + \text{tri. } HAL$; or $4 \text{tri. } ABK = 4 \text{tri. } HBR + 4 \text{tri. } HAL. \therefore h^2 = a^2 + b^2$. Q.E.D.

a. See Versluys, p. 93, fig. 107; and found in Journal de Mathein, 1897, credited to Brand. (10/23, '33, 9 p. m. E. S. L.).

Sixty-Five

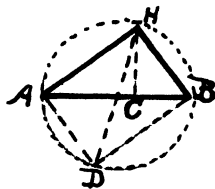


Fig. 63

The construction is obvious. From the similar triangles HDA and HBC , we have $HD : HB = AD : CB$, or $HD \times CB = HB \times AD$. --- (1)

In like manner, from the similar triangles DHB and AHC , $HD \times AC = AH \times DB$. --- (2) Adding (1) and (2), $HD \times AB = HB \times AD + AH \times DB$. --- (3). $\therefore h^2 = a^2 + b^2$.

a. See Halsted's Elementary Geom., 6th Ed'n, 1895 for Eq. (3), p. 202; Edwards' Geom., p. 158, fig. 17; Am. Math. Mo., V. IV, p. 11.

b. Its first appearance in print, it seems, was in Runkle's Math. Mo., 1859, and by Runkle credited to C. M. Raub, of Allentown, Pa.

c. May not a different solution be obtained from other proportions from these same triangles?

Sixty-Six

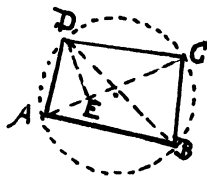


Fig. 64

Ptolemy's Theorem (A.D. 87-168). If ABCD is any cyclic (inscribed) quadrilateral, then $AD \times BC + AB \times CD = AC \times BD$.

As appears in Wentworth's Geometry, revised edition (1895), p. 176, Theorem 238. Draw DE making $\angle CDE = \angle ADB$. Then the tri's ABD and CDE are similar; also the tri's BCD and ADE are similar. From these pairs of similar triangles it follows that $AC \times BD = AD \times BC + DC \times AB$. (For full demonstration, see Teacher's Edition of Plane and Solid Geometry (1912), by Geo. Wentworth and David E. Smith, p. 190, Proof 11.)

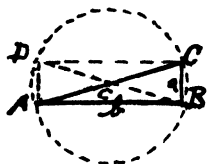


Fig. 65

In case the quad. ABCD becomes a rectangle then $AC = BD$, $BC = AD$ and $AB = CD$. So $AC^2 = BC^2 + AD^2$, or $c^2 = a^2 + b^2$. \therefore a special case of Ptolemy's Theorem gives a proof of the Pyth. Theorem.

a. As formulated by the author. Also see "A Companion to Elementary School Mathematics (1924), by F. C. Boon, B.A., p. 107, proof 10.

Sixty-Seven

Circumscribe about tri. ABH circle BHA. Draw $AD = DB$. Join HD. Draw CG perp. to HD at H, and AC and BG each perp. to CG; also AE and BF perp. to HD. Quad's CE and FG are squares. Tri's HDE and

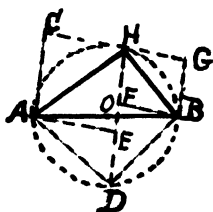


Fig. 66

DBF are congruent. $\therefore AE = DF = EH = AC$. $HD = HF + FD = BG + AC$. Quad. $ADBH = \frac{1}{2}HD(BF + AE) = \frac{1}{2}HD \times CG$. Quad. $ABGC = \frac{1}{2}(AC + BG) \times CG = \frac{1}{2}HD \times CG$. \therefore tri. $ADB =$ tri. $AHC +$ tri. HBG . $\therefore 4$ tri. $ADB = 4$ tri. $AHC + 4$ tri. HBG . $\therefore h^2 = a^2 + b^2$. Q.E.D.

- a. See E. Fourrey's *C. Geom.*, 1907; credited to Piton-Bressant; see Versluys, p. 90, fig. 103.
b. See fig. 333 for Geom. Proof--so-called.

Sixty-Eight

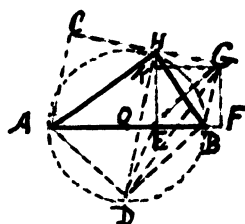


Fig. 67

Construction same as in fig. 66, for points C, D and G. Join DG. From H draw HE perp. to AB, and join EG and ED. From G draw GK perp. to HE and GF perp. to AB, and extend AB to F. KF is a square, with diag. GE. \therefore angle $BEG =$ angle $EBD = 45^\circ$. \therefore GE and BD are parallel. Tri. $BDG =$ tri. BDE . --- (1) Tri. $BGH =$ tri. BGD . --- (2) \therefore (1) = (2), or tri. BGH

= tri. BDE . Also tri. $HCA =$ tri. ADE . \therefore tri. $BGH +$ tri. $HCA =$ tri. ADB . So 4 tri. $ADB = 4$ tri. $BHG + 4$ tri. HCA . $\therefore h^2 = a^2 + b^2$. Q.E.D.

a. See Versluys, p. 91, fig. 104, and credited also to Piton-Bressant, as found in E. Fourrey's *Geom.*, 1907, p. 79, IX.

- b. See fig. 334 of Geom. Proofs.

Sixty-Nine

In fig. 63 above it is obvious that $AB \times BH = AH \times DB + AD \times BH$. $\therefore AB^2 = HA^2 + HB^2$. $\therefore h^2 = a^2 + b^2$.

a. See *Math. Mo.*, 1859, by Runkle, Vol. II, No. 2, Dem. 22, fig. 11.

b. This is a particular case of Prop. XXXIII, Book IV, p. 121, Davies Legendre (1858) which is Exercise 10, in Schuyler's Geom. (1876), Book III, p. 173, or Exercise 238, Wentworth's New Plane Geom. (1895), Book III, p. 176.

Seventy

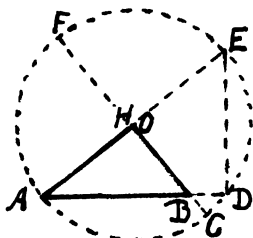


Fig. 68

On any diameter as AE = 2AH, const. rt. tri. ABH, and produce the sides to chords. Draw ED. From the sim. tri's ABH and AED, $AB : AE = AH : AD$, or $h : b + HE = b : h + BD$. $\therefore h(h + BD) = b(b + HE) = b^2 + b \times HE = b^2 + HF \times HC = b^2 + HC^2$. --- (1) Now conceive AD to revolve on A as a center until D coincides with C, when $AB = AD = AC = h$, $BD = 0$, and $HB = HC = a$. Substituting in (1) we have $h^2 = a^2 + b^2$.

a. This is the solution of G. I. Hopkins of Manchester, N.H. See his Plane Geom., p. 92, art. 427; also see Jour. of Ed., 1888, V. XXVII, p. 327, 16th prob. Also Heath's Math. Monographs, No. 2, p. 28, proof XV.

b. Special case. When H coincides with O we get (1) $BC = (b + c)(b - a)/h$, and (2) $BC = 2b^2/h - h$. Equating, $\therefore h^2 = a^2 + b^2$.

c. See Am. Math. Mo., V. III, p. 300.

(2) The Method by Secants.

Seventy-One

With H as center and HB as radius describe the circle EBD.

The secants and their external segments bring reciprocally proportional, we have, $AD : AB = AF : AE$,

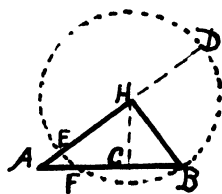


Fig. 69

or $b + a : h = (h - 2CB = h - \frac{2a^2}{h})$

$: b - a$, whence $h^2 = a^2 + b^2$.

a. In case $b = a$, the points A, E and F coincide and the proof still holds; for substituting b for a the above prop'n reduces to $h^2 - 2a^2 = 0$; $\therefore h^2 = 2a^2$ as it should.

b. By joining E and B, and F and D, the similar triangles upon which the above rests are formed.

Seventy-Two

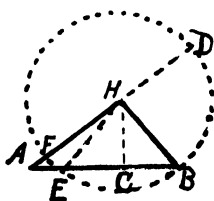


Fig. 70

With H as center and HB as radius describe circle FBD, and draw HE and HC to middle of EB.

$AE \times AB = AF \times AD$, or
 $(AD - 2BC)AB = (AH - HB)(AH + HB)$.
 $\therefore AB^2 - 2BC \times AB = AH^2 - HB^2$. And
 as $BC : BH = BH : AB$, then $BC \times AB = HB^2$, or $2BC \times AB = 2BH^2$. So $AB^2 - 2BH^2 = AH^2 - HB^2$. $\therefore AB^2 = HB^2 + HA^2$. $\therefore h^2 = a^2 + b^2$. Q.E.D.

a. Math. Mo., Vol. II, No. 2, Dem. 25, fig. 2. Derived from: Prop. XXIX, Book IV, p. 118, Davies Legendre (1858); Prop. XXXIII, Book III, p. 171, Schuyler's Geometry (1876); Prop. XXI, Book III, p. 163, Wentworth's New Plane Geom. (1895).

Seventy-Three

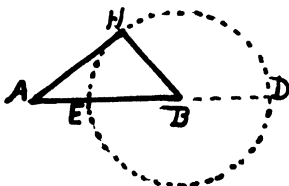


Fig. 71

$AE : AH = AH : AD$. \therefore
 $AH^2 = AE \times AD = AE(AB \times BH)$
 $= AE \times AB + AE \times BH$. So $AH^2 + BH^2 = AE \times AB + AE \times HB + HB^2 = AE \times AB + HB(AE + BH) = AB(AE + BH) = AB^2$. $\therefore h^2 = a^2 + b^2$. Q.E.D.

a. See Math. Mo.,

(1859), Vol. II, No. 2, Dem. 26, p. 13; derived from Prop. XXX, p. 119, Davis Legendre; Schuyler's Geom., Book III, Prop. XXXII, Cor. p. 172 (1876); Wentworth's Geom., Book III, Prop. XXII, p. 164. It is credited to C. J. Kemper, Harrisonburg, Va., and Prof. Charles A. Young (1859), at Hudson, O. Also found in Fourrey's collection, p. 93, as given by J. J. I. Hoffmann, 1821.

Seventy-Four

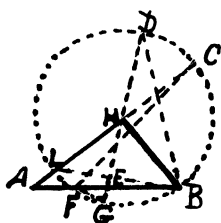


Fig. 72

In fig. 72, E will fall between A and F at F, or between F and B, as HB is less than, equal to, or greater than HE. Hence there are three cases; but investigation of one case--when it falls at middle point of AB--is sufficient.

Join L and B, and F and C, making the two similar triangles AFC and ALB; whence $h : b + a = b - a : AF$; $\therefore AF = \frac{b^2 - a^2}{h}$. --- (1)

Join F and G, and B and D making the two similar tri's FGE and BDE, whence $\frac{1}{2}h : a - \frac{1}{2}h = a + \frac{1}{2}h : FE$, whence $FE = \frac{a^2 - \frac{1}{4}h^2}{\frac{1}{2}h}$, --- (2). Adding (1) and (2) gives $\frac{1}{2}h = \frac{a^2 + b^2 - \frac{1}{4}h^2}{h}$; whence $h^2 = a^2 + b^2$.

a. The above solution is given by Krueger, in "Aumerkungen uber Hrn. geh. R. Wolf's Auszug aus der Geometrie," 1746. Also see Jury Wipper, p. 41, fig. 42, and Am. Math. Mo., V. IV, p. 11.

b. When G falls midway between F and B, then fig. 72 becomes fig. 69. Therefore cases 69 and 72 are closely related.

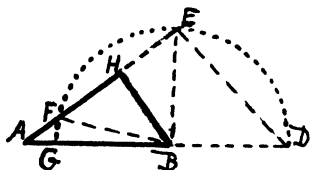
Seventy-five

Fig. 73a

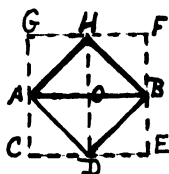


Fig. 73b

In fig. 73a, take $HF = HB$. With B as center, and BF as radius describe semi-circle DEG, G being the pt. where the circle intersects AB. Produce AB to D, and draw FG, FB, BE to AH produced, and DE, forming the similar tri's AGF and AED, from which $(AG = x) : (AF = y) = (AE = y + 2FH) : (AD = x + 2BG) = y + 2z : x + 2r$ whence $x^2 + 2rx = y^2 + 2yz$. --- (1).

But if, see fig. 73b, $HA = HB$, (sq. $GE = h^2$) = (sq. $HB = a^2$) + (4 tri. $AHG = \text{sq. } HA = b^2$), whence $h^2 = a^2 + b^2$; then, (see fig. 73a) when $BF = BG$, we will have $BG^2 = HB^2 + HF^2$, or $r^2 = z^2 + z^2$, (since $z = FH$). --- (2).
 (1) + (2) = (3) $x^2 + 2rx + r^2 = y^2 + 2yz + z^2 + z^2$ or (4) $(x + r)^2 = (y + z)^2 + z^2$. \therefore (5) $h^2 = a^2 + b^2$, since $x + r = AB = h$, $y + z = AH = b$, and $z = HB = a$.

a. See Jury Wipper, p. 36, where Wipper also credits it to Joh. Hoffmann. See also Wipper, p. 37, fig. 34, for another statement of same proof; and Fourrey, p. 94, for Hoffmann's proof.

Seventy-Six

In fig. 74 in the circle whose center is O, and whose diameter is AB, erect the perp. DO, join D to A and B, produce DA to F, making $AF = AH$, and produce HB to G making $BG = BD$, thus forming the two isosceles tri's FHA and DGB; also the two isosceles tri's ARD and BHS. As angle $DAH = 2$ angle at F, and angle $HBD = 2$ angle at G, and as angle DAH and angle

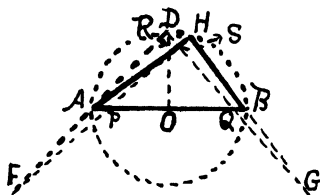


Fig. 74

HBD are measured by same arc HD, then angle at F = angle at G. \therefore arc AP = arc QB.

And as angles ADR and BHS have same measure, $\frac{1}{2}$ of arc APQ, and $\frac{1}{2}$ of arc BQP, respectively, then tri's ARD and BHS are similar, R is the intersection of AH and DG, and S the intersection of BD

and HF. Now since tri's FSD and GHR are similar, being equiangular, we have, DS : DF = HR : HG. \therefore DS : (DA + AF) = HR : (HB + BG).

$$\begin{aligned} \therefore DS : (DA + AH) &= HR : (HB + BD), \\ \therefore DS : (2BR + RH) &= HR : (2BS + SD), \\ \therefore (1) DS^2 + 2DS \times BS &= HR^2 + 2HR \times BR. \end{aligned}$$

$$\text{And (2) } HA^2 = (HR + RA)^2 = HR^2 + 2HR \times RA + RA^2 = HR^2 + 2HR \times RA + AD^2$$

$$\begin{aligned} (3) HB^2 &= BS^2 = (BD - DS)^2 = BD^2 - 2BD \times DS + DS^2 \\ &= AD^2 - (2BD \times DS - DS^2) = AD^2 - 2(BS + SD)DS + DS^2 \\ &= AD^2 - 2BS \times SD - 2DS^2 + DS^2 = AD^2 - 2BS \times DS \\ &\quad - DS^2 = AD^2 - (2BS \times DS - DS^2) \end{aligned}$$

$$(2) + (3) = (4) HB^2 + HA^2 = 2AD^2. \text{ But as in proof, fig. 73b, we found, (eq. 2), } r^2 = z^2 + z^2 = 2z^2. \\ \therefore 2AD^2 \text{ (in fig. 74) } = AB^2. \therefore h^2 = a^2 + b^2.$$

a. See Jury Wipper, p. 44, fig. 43, and there credited to Joh. Hoffmann, one of his 32 solutions.

Seventy-Seven

In fig. 75, let BCA be any triangle, and let AD, BE and CF be the three perpendiculars from the three vertices, A, B and C, to the three sides, BC, CA and AB, respectively. Upon AB, BC and CA as diameters describe circumferences, and since the angles ADC, BEC and CFA are rt. angles, the circumferences pass through the points D and E, F and E, and F and D, respectively.

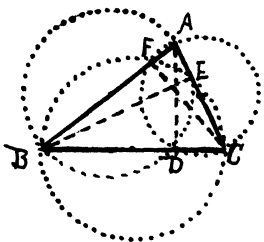


Fig. 75a

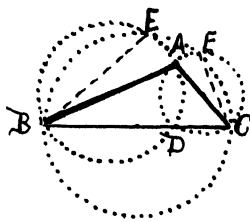


Fig. 75b

Since $BC \times BD = BA \times BF$, $CB \times CD = CA \times CE$, and $AB \times AF = AC \times AE$, therefore

$$\begin{aligned} & [BC \times BD + CB \times CD = BC(BD + CD) = BC^2] \\ = & [BA \times BF + CA \times CE = BA^2 + AB \times AF + CA^2 + AC \times AE \\ & = AB^2 + AC^2 + 2AB \times AF \text{ (or } 2AC \times AE)]. \end{aligned}$$

When the angle A is acute (fig. 75a) or obtuse (fig. 75b) the sign is - or + respectively. And as angle A approaches 90° , AF and AE approach 0, and at 90° they become 0, and we have $BC^2 = AB^2 + AC^2$. \therefore when A = a rt. angle $h^2 = a^2 + b^2$.

a. See Olney's Elements of Geometry, University Edition, Part III, p. 252, art. 671, and Heath's Math. Monographs, No. 2, p. 35, proof XXIV.

Seventy-Eight

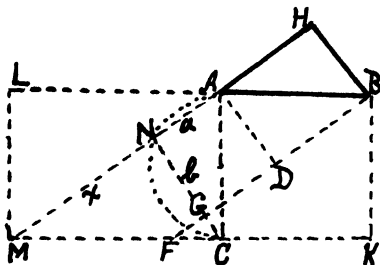


Fig. 76

Produce KC and HA to M, complete the rect. MB, draw BF par. to AM, and draw CN and AP perp. to HM.

Draw the semi-circle ANC on the diameter AC. Let $MN = x$. Since the area of the paral. MFBA = the area of the sq. AK, and since, by the Theorem for the

measurement of a parallelogram, (see fig. 308, this text), we have (1) sq. AK = (BF × AP = AM × AP) = a(a + x). But, in tri. MCA, CN is a mean proportional between AN and NM. ∴ (2) b² = ax. (1) - (2) = (3) h² - b² = a² + ax - ax = a². ∴ h² = a² + b². Q.E.D.

a. This proof is No. 99 of A. R. Colburn's 108 solutions, being devised Nov. 1, 1922.

(3) The Method by Tangents

1st.--The Hypotenuse as a Tangent

Seventy-Nine

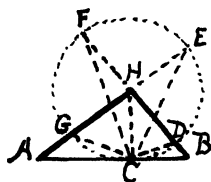


Fig. 77

Draw HC perp. to AB, and with H as a center and HC as a radius describe circle GDEF. From the similar tri's ACG and AEC, AC : AE = AG : AC, or AC : b + r = b - r : AC; ∴ (1) AC² = b² - r². From the similar tri's CBD and BFC, we get (2) CB² = a² - r². From the similar rt. tri's BCH and HCA, we get (3) BC × AC = r². ∴ (4) 2BC × AC = 2r². (1) + (2) + (4) gives (5) AC² + 2AC × BC + BC² = a² + b² = (AC + BC)² = AB². ∴ h² = a² + b².

a. See Am. Math. Mo., V. III, p. 300.

Eighty

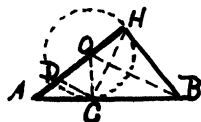


Fig. 78

O, the center of the circle, lies on the bisector of angle B, and on AH.

With the construction completed, from the similar tri's ACD and AHC, we get, calling OC = r, (AC = h - a) : (AH = b) = (AD = b - 2r) : (AC = h - a). ∴ (1) (h - a)² = b² - 2br. But (2) a² = a². (1) + (2) = (3) (h - a)² + a² = a² + b² - 2br, or (h - a)² + 2br + a² = a² + b².

Also $(AC = h - a) : (AH = b) = (OC = OH = r) : (HB = a)$,
whence

$$(4) (h - a)a = br.$$

$$\therefore (5) (h - a)^2 + 2(h - a)r + a^2 = a^2 + b^2$$

$$\therefore (6) h^2 = a^2 + b^2.$$

Or, in (3) above, expand and factor gives

$$(7) h^2 - 2a(h - a) = a^2 + b^2 - 2br. \text{ Sub. for } a(h - a) \text{ its equal, see (4) above, and collect, we have}$$

$$(8) h^2 = a^2 + b^2.$$

a. See Am. Math. Mo., V. IV, p. 81.

2nd.--The Hypotenuse a Secant Which Passes Through the Center of the Circle and One or Both Legs Tangents

Eighty-One

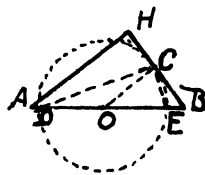


Fig. 79

Having HB, the shorter leg, a tangent at C, any convenient pt. on HB, the construction is evident.

From the similar tri's BCE and BDC, we get $BC : BD = BE : BC$, whence $BC^2 = BD \times BE = (BO + OD)BE = (BO + OC)BE$.---(1) From similar tri's OBC and ABH, we get $OB : AB = OC : AH$, whence $\frac{OB}{h} = \frac{r}{b}$; $\therefore BO$

$$= \frac{hr}{b} \text{ .---(2) } BC : BH = OC : AH, \text{ whence } BC = \frac{ar}{b} \text{ .---(3)}$$

Substituting (2) and (3) in (1), gives,

$$\frac{a^2 r^2}{b^2} = \left(\frac{hr}{b} + r\right)BE = \left(\frac{hr + br}{b}\right)(BO - OC) = \left(\frac{hr + br}{b}\right)\left(\frac{hr + br}{b}\right) \text{ .---(4) whence } h^2 = a^2 + b^2. \text{ Q.E.D.}$$

a. Special case is: when, in Fig. 79, O coincides with A, as in Fig. 80.

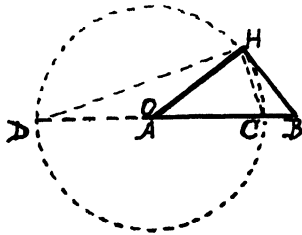
Eighty-Two

Fig. 80

With A as center and AH as radius, describe the semicircle BHD.

From the similar triangles BHC and BDH, we get, $h - b : a = a : h + b$, whence directly $h^2 = a^2 + b^2$.

a. This case is found in: Heath's Math. Monographs, No. 1, p. 22, proof VII; Hopkins' Plane Geom., p. 92, fig. IX; Journal of Education,

1887, V. XXVI, p. 21, fig. VIII; Am. Math. Mo., V. III, p. 229; Jury Wipper, 1880, p. 39, fig. 39, where he says it is found in Hubert's Elements of Algebra, Wurceh, 1792, also in Wipper, p. 40, fig. 40, as one of Joh. Hoffmann's 32 proofs. Also by Richardson in Runkle's Mathematical (Journal) Monthly, No. 11, 1859 --one of Richardson's 28 proofs; Versluys, p. 89, fig. 99.

b. Many persons, independent of above sources, have found this proof.

c. When O, in fig. 80, is the middle pt. of AB, it becomes a special case of fig. 79.

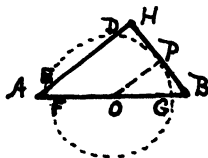
Eighty-Three

Fig. 81

Assume $HB < HA$, and employ tang. HC and secant HE, whence $HC^2 = HE \times HD = AD \times AE = AG \times AF = BF \times BG = BC^2$. Now employing like argument as in proof Eighty-One we get $h^2 = a^2 + b^2$.

a. When O is the middle point of AB, and $HB = HA$, then HB and HA are tangents, and $AG = BF$, secants, the argument is same as (c), proof Eighty-Two, by applying theory of limits.

b. When O is any pt. in AB, and the two legs

are tangents. This is only another form of fig. 79 above, the general case. But as the general case gives, see proof, case above, $h^2 = a^2 + b^2$, therefore the special *must* be true, whence in this case (c) $h^2 = a^2 + b^2$. Or if a *proof* by explicit argument is desired, proceed as in fig. 79.

Eighty-Four

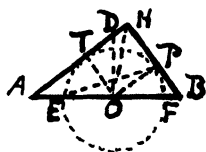


Fig. 82

By proving the general case, as in fig. 79, and then showing that some case is only a particular of the general, and therefore true immediately, is here contrasted with the following long and complex solution of the assumed particular case.

The following solution is given in The Am. Math. Mo., V. IV,

p. 80:

"Draw OD perp. to AB. Then, $AT^2 = AE \times AF = AO^2 - EO^2$
 $= AO^2 - TH^2$.---(1)

$BP^2 = BF \times BE = BO^2 - FO^2 = BO^2 - HP^2$.---(2)

Now, $AO : OT = AD : OD$;

$\therefore AO \times OD = OT \times AD$.

And, since $OD = OB$, $OT = TH = HP$, and $AD = AT + TD$
 $= AT + BP$.

$\therefore AT \times TH + HP \times BP = AO \times OB$.---(3)

Adding (1), (2), and $2 \times (3)$,

$AT^2 + BP^2 + 2AT \times TH + 2HP \times BP = AO^2 - TH^2 + BO^2$
 $- HP^2 + 2AO \times OB$;

$\therefore AT^2 + 2AT \times TH + TH^2 + BP^2 + 2BP \times HP + HP^2 = AO^2$
 $+ 2AO \times OB + BO^2$.

$\therefore (AT + TH)^2 + (BP + HP)^2 = (AO + OB)^2$.

$\therefore AH^2 + BH^2 = AB^2$." Q.E.D.

$\therefore h^2 = a^2 + b^2$.

3rd.--The Hypotenuse a Secant Not Passing Through the Center of the Circle, and Both Legs Tangents

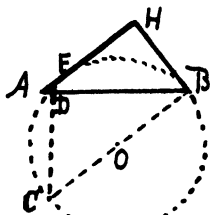


Fig. 83

Eighty-Five

Through B draw BC parallel to HA, making $BC = 2BH$; with O, the middle point of BC, as center, describe a circumference, tangent at B and E, and draw CD, forming the two similar rt. tri's ABH and BDC, whence $BD : (AH = b) = (BC = 2a)$

$$: (AB = h) \text{ from which, } DB = \frac{2ab}{h}. \quad (1)$$

Now, by the principal of tang. and sec. relations, $(AE^2 = [b - a]^2) = (AB = h)(AD = h - DB)$, whence

$$DB = h - \frac{(b - a)^2}{h} \text{ .--- (2)}$$

Equating (1) and (2) gives $h^2 = a^2 + b^2$.

a. If the legs HB and HA are equal, by theory of limits same result obtains.

b. See Am. Math. Mo., V. IV, p. 81, No. XXXII.

c. See proof Fifty-Two above, and observe that this proof Eighty-Five is superior to it.

*4th.--Hypotenuse and Both Legs Tangents***Eighty-Six**

The tangent points of the three sides are C, D and E.

Let $OD = r = OE = OC$, $AB = h$, $BH = a$ and $AH = b$.

Now,

$$(1) h + 2r = a + b.$$

$$(2) h^2 + 4hr + 4r^2 = a^2 + 2ab + b^2.$$

$$(3) \text{ Now if } 4hr + 4r^2 = 2ab, \text{ then } h^2 = a^2 + b^2.$$

$$(4) \text{ Suppose } 4hr + 4r^2 = 2ab.$$

$$(5) 4r(h + r) = 2ab; \therefore 2r(h + r) = ab.$$

$$(1) = (6) 2r = a + b - h. \quad (6) \text{ in } (5) \text{ gives}$$

$$(7) (a + b - h)(h + r) = ab.$$

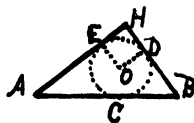


Fig. 84

$$(8) h(a + b - h - r) + ar + br = ab.$$

(1) = (9) $r = (a + b - h - r)$. (9) in (8) gives
 (10) $hr + ar + br = ab$.

(11) But $hr + ar + br = 2 \text{ area tri. ABC}$.

(12) And $ab = 2 \text{ area tri. ABC}$.

$$\therefore (13) hr + ar + br = ab = hr + r(a + b) = hr + r(h + 2r)$$

$$\therefore (14) 4hr + 4r^2 = 2ab.$$

\therefore the supposition in (4) is true.

$$\therefore (15) h^2 = a^2 + b^2. \quad \text{Q.E.D.}$$

a. This solution was devised by the author Dec. 13, 1901, before receiving Vol. VIII, 1901, p. 258, Am. Math. Mo., where a like solution is given; also see Fourrey, p. 94, where credited.

b. By drawing a line OC, in fig. 84, we have the geom. fig. from which, May, 1891, Dr. L. A. Bauer, of Carnegie Institute, Wash., D.C., deduced a proof through the equations

$$(1) \text{ Area of tri ABH} = \frac{1}{2}r(h + a + b), \text{ and}$$

(2) $HD + HE = a + b - h$. See pamphlet: On Rational Right-Angled Triangles, Aug., 1912, by Artemus Martin for the Bauer proof. In same pamphlet is still another proof attributed to Lucius Brown of Hudson, Mass.

c. See Olney's Elements of Geometry, University Edition, p. 312, art. 971, or Schuyler's Elements of Geometry, p. 353, exercise 4; also Am. Math. Mo., V. IV, p. 12, proof XXVI; also Versluys, p. 90, fig. 102; also Grunert's Archiv. der Matheın, and Physik, 1851, credited to Möllmann.

d. Remark.--By ingenious devices, some if not all, of these in which the circle has been employed can be proved without the use of the circle--not nearly so easily perhaps, but proved. The figure, without the circle, would suggest the device to be employed. By so doing new proofs may be discovered.

Eighty-Seven

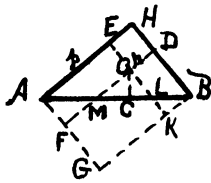


Fig. 85

Complete rect. HG. Produce DO to F and EO to K. Designate $AC = AE$ by p , $BD = BC$ by q and $HE = HD$ by r .

Then $a = q + r$, $b = p + r$, and $h = p + q$. Tri. FMA = tri. OMC and tri. COL = tri. KLB.

\therefore tri. AGB = rect. FGKO = tri. ABH = $\frac{1}{2}$ rect. HG. Rect. FGKO

= rect. AFOE + sq. ED + rect. OKBD.

So $pq = pr + r^2 + qr$.

whence $2pq = 2qr + 2r^2 + 2pr$.

But $p^2 + a^2 = p^2 + q^2$.

$\therefore p^2 + 2pq + q^2 = (q^2 + 2qr + r^2) + (p^2 + 2pr + r^2)$

or $(p + q)^2 = (q + r)^2 + (p + r)^2$

$\therefore h^2 = a^2 + b^2$.

a. Sent to me by J. Adams, from The Hague, and credited to J. F. Vaes, XIII, 4 (1917).

(II).--Through the Use of Two Circles.

Eighty-Eight

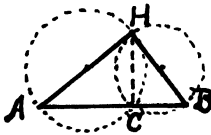


Fig. 86

Construction. Upon the legs of the rt. tri. ABH, as diameters, construct circles and draw HC, forming three similar rt. tri's ABH, HBC and HAC.

Whence $h : b = b : AC$. $\therefore hAC = b^2$.----(1)

Also $h : a = a : BC$. $\therefore hBC = a^2$.----(2)

(1) + (2) = (3) $h^2 = a^2 + b^2$. Q.E.D.

a. Another form is:

(1) $HA^2 = HC \times AB$. (2) $BH^2 = BC \times AB$.

Adding, (3) $AH^2 + BH^2 = AC \times AB + BC \times AB = AB(AC + BC) = AB^2$. $\therefore h^2 = a^2 + b^2$.

b. See Edwards' Elements of Geom., p. 161, fig. 34 and Am. Math. Mo., V. IV, p. 11; Math. Mo. (1859), Vol. II, No. 2, Dem. 27, fig. 13; Davies Legendre, 1858, Book IV, Prop. XXX, p. 119; Schuyler's Geom. (1876), Book III, Prop. XXXIII, cor., p. 172; Wentworth's New Plane Geom. (1895), Book III, Prop. XXII, p. 164, from each of said Propositions, the above proof Eighty-Eight may be derived.

Eighty-Nine

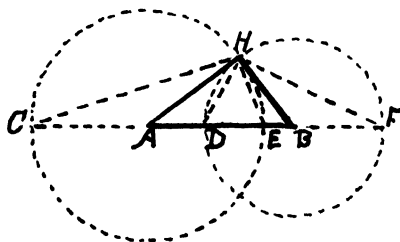


Fig. 87

With the legs of the rt. tri. ABH as radii describe circumferences, and extend AB to C and F. Draw HC, HD, HE and HF. From the similar tri's AHF and HDH,

$$\begin{aligned} AF : AH &= AH : AD \\ \therefore b^2 &= AF \times AD. \text{--- (1)} \end{aligned}$$

From the similar tri's CHB and HEB,

$$\begin{aligned} CB : HB &= HB : BE. \quad \therefore a^2 = CB \times BE. \text{--- (2)} \\ (1) + (2) &= (3) \quad a^2 + b^2 = CB \times BE + AF \times AD \\ &= (h + b)(h - b) + (h + a)(h - a) \\ &= h^2 - b^2 + h^2 - a^2; \\ \therefore (4) \quad 2h^2 &= 2a^2 + 2b^2. \quad \therefore h^2 = a^2 + b^2. \end{aligned}$$

a. Am. Math. Mo., V. IV, p. 12; also on p. 12 is a proof by Richardson. But it is much more difficult than the above method.

Ninety

For proof Ninety use fig. 87.

$$\begin{aligned} AH^2 &= AD(AB + BH). \text{--- (1)} \quad BH^2 = BE(BA + AH). \text{--- (2)} \\ (1) + (2) &= (3) \quad BH^2 + AH^2 = BH(BA + AH) + AD(AB + BH) \\ &= BH \times BA + BE \times AH + AD \times HB + AD \times BH \\ &= HB(BE + AD) + AD \times BH + BE \times AH + BE \times AB - BE \times AB \end{aligned}$$

$$\begin{aligned}
&= AB(BE + AD) + AD \times BH + BE(AH + AB) - BE \times AB \\
&= AB(BE + AD) + AD \times BH + BE(AH + AE + BE) - BE \times AB \\
&= AB(BE + AD) + AD \times BH + BE(BE + 2AH) - BE \times AB \\
&= AB(BE + AD) + AD \times BH + BE^2 + 2BE \times AH - BE \times AB \\
&= AB(BE + AD) + AD \times BH + BE^2 + 2BE \times AE - BE(AD + BD) \\
&= AB(BE + AD) + AD \times BH + BE^2 + 2BE \times AE - BE \times AD \\
&\quad - BE \times BD \\
&= AB(BE + AD) + AD \times BH + BE(BE + 2AE) - BE(AD + BD) \\
&= AB(BE + AD) + AD \times BH + BE(AB + AH) - BE(AD + BD) \\
&= AB(BE + AD) + AD \times BH + (BE \times BC = BH^2 = BD^2) \\
&\quad - BE(AD + BD) \\
&= AB(BE + AD) + (AD + BD)(BD - BE) \\
&= AB(BE + AD) + AB \times DE = AB(BE + AD + DE) \\
&= AB \times AB = AB^2. \quad \therefore h^2 = a^2 + b^2. \quad \text{Q.E.D.}
\end{aligned}$$

a. See Math. Mo. (1859), Vol. II, No. 2, Dem. 28, fig. 13--derived from Prop. XXX, Book IV, p. 119, Davies Legendre, 1858; also Am. Math. Mo., Vol. IV, p. 12, proof XXV.

Ninety-One

For proof Ninety-One use fig. 87. This proof is known as the "Harmonic Proportion Proof."

From the similar tri's AHF and ADH,

$$AH : AD = AF : AH, \text{ or } AC : AD = AF : AE$$

whence $AC + AD : AF + AE = AD : AE$

or $CD : CF = AD : AE,$

and $AC - AD = AF - AE = AD : AE,$

or $DE : EF = AD : AE.$

$$\therefore CD : CF = DC : EF.$$

or $(h + b - a) : (h + b + a) = (a - h + b) : (a + h + b)$

\therefore by expanding and collecting, we get

$$h^2 = a^2 + b^2.$$

a. See Olney's Elements of Geom., University Ed'n, p. 312, art. 971, or Schuyler's Elements of Geom., p. 353, Exercise 4; also Am. Math. Mo., V. IV, p. 12, proof XXVI.

D.--Ratio of Areas

As in the three preceding divisions, so here in D we must rest our proofs on similar rt. triangles.

Ninety-Two

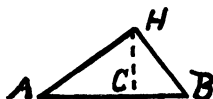


Fig. 88

Draw HC perp. to AB, forming the three similar triangles ABH, AHC and HBC, and denote $AB = h$, $HB = a$, $HA = b$, $AC = x$, $CB = y$ and $HC = z$.

Since similar surfaces are proportional to the squares of their homologous dimensions, therefore,

$$\begin{aligned} \left[\frac{1}{2}(x+y)z + \frac{1}{2}yz = h^2 + a^2 \right] &= \left[\frac{1}{2}yz + \frac{1}{2}xz = a^2 + b^2 \right] \\ &= \left[\frac{1}{2}(x+y)z + \frac{1}{2}yz = (a^2 + b^2)a^2 \right] \\ \therefore h^2 + a^2 &= (a^2 + b^2) + a^2 \\ \therefore h^2 &= a^2 + b^2. \end{aligned}$$

a. See Jury Wipper, 1880, p. 38, fig. 36 as found in Elements of Geometry of Bezout; Fourrey, p. 91, as in Wallis' Treatise of Algebra, (Oxford), 1685; p. 93 of Cours de Mathematiques, Paris, 1768. Also Heath's Math. Monographs, No. 2, p. 29, proof XVI; Journal of Education, 1888, V. XXVII, p. 327, 19th proof, where it is credited to L. J. Bullard, of Manchester, N.H.

Ninety-Three

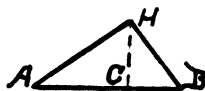


Fig. 89

As the tri's ACH, HCB and ABH are similar, then tri. HAC : tri. BHC : tri. ABH = AH^2 : BH^2 : AB^2 , and so tri. AHC + tri. BHC : tri. ABH = AH^2 + BH^2 : AB^2 . Now tri. AHC + tri. BHC : tri. ABH = 1. $\therefore AB^2 = BH^2 + AH^2$. $\therefore h^2 = a^2 + b^2$. Q.E.D.

a. See Versluys, p. 82, proof 77, where credited to Bezout, 1768; also Math. Mo., 1859, Vol. II, Dem. 5, p. 45; also credited to Oliver; the School

Visitor, Vol. 20, p. 167, says Pythagoras gave this proof--but no documentary evidence.

Also Stanley Jashemski a school boy, age 19, of So. High School, Youngstown, O., in 1934, sent me same proof, as an original discovery on his part.

b. Other proportions than the explicit one as given above may be deduced, and so other symbolized proofs, from same figure, are derivable--see Versluys, p. 83, proof 78.

Ninety-Four

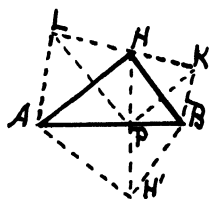


Fig. 90

Tri's ABH and ABH' are congruent; also tri's AHL and AHP: also tri's BKH and BPH. Tri. ABH = tri. BHP + tri. HAP = tri. BKH + tri. AHL. \therefore tri. ABH : tri. BKH : tri. AHL = h^2 : a^2 : b^2 , and so tri. ABH : (tri. BKH + tri. AHL) = h^2 : $a^2 + b^2$, or $l = h^2 + (a^2 + b^2)$. $\therefore h^2 = a^2 + b^2$. Q.E.D.

a. See Versluys, p. 84, fig. 93, where it is attributed to Dr. H. A. Naber, 1908. Also see Dr. Leitzmann's work, 1930 ed'n, p. 35, fig. 35.

Ninety-Five

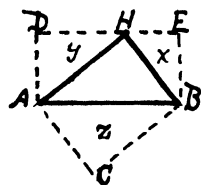


Fig. 91

Complete the paral. HC, and the rect. AE, thus forming the similar tri's BHE, HAD and BAG. Denote the areas of these tri's by x, y and z respectively.

Then $z : y : x = h^2 : a^2 : b^2$.

But it is obvious that z

= $x + y$.

$\therefore h^2 = a^2 + b^2$.

a. Original with the author, March 26, 1926,
10 p.m.

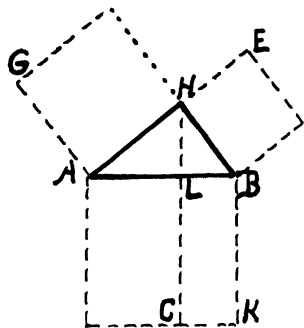
Ninety-Six

Fig. 92

Draw HL perp. to AB.
 Since the tri's ABH, AHL, and HBL are similar, so also the squares AK, BE and HG, and since similar polygons are to each other as the squares of their homologous dimensions, we have

$$\begin{aligned} \text{tri. ABH} &: \text{tri. HBL} : \text{tri. AHL} \\ &= h^2 : a^2 : b^2 \\ &= \text{sq. AK} : \text{sq. BE} : \text{sq. HG.} \\ \text{But tri. ABH} &= \text{tri. HBL} + \text{tri. AHL.} \\ \therefore \text{sq. AK} &= \text{sq. BE} + \text{sq. HG.} \\ \therefore h^2 &= a^2 + b^2. \end{aligned}$$

a. Devised by the author, July 1, 1901, and afterwards, Jan. 13, 1934, found in Fourrey's Curio Geom., p. 91, where credited to R. P. Lamy, 1685.

Ninety-Seven

Use fig. 92 and fig. 1.

Since, by equation (5), see fig. 1, Proof One, $BH^2 = BA \times BL = \text{rect. LK}$, and in like manner, $AH^2 = AB \times AL = \text{rect. AC}$, therefore $\text{sq. AK} = \text{rect. LK} + \text{rect. AC} = \text{sq. BE} + \text{sq. HG}$.
 $\therefore h^2 = a^2 + b^2$. Q.E.D.

a. Devised by the author July 2, 1901.

b. This principle of "mean proportional" can be made use of in many of the here-in-after figures among the Geometric Proofs, thus giving variations as to the proof of said figures. Also many other figures may be constructed based upon the use of the "mean proportional" relation; hence all such proofs, since they result from an algebraic relationship of corresponding lines of similar triangles, must be classed as algebraic proofs.

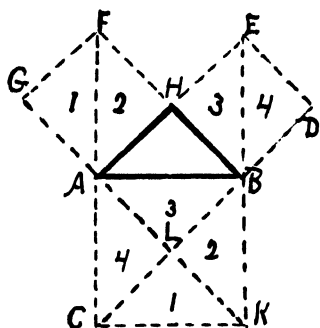
*E.--Algebraic Proof, Through Theory of Limits***Ninety-Eight**

Fig. 93

The so-called Pythagorean Theorem, in its simplest form is that in which the two legs are equal. The great Socrates (b. 500 B.C.), by drawing replies from a slave, using his staff as a pointer and a figure on the pavement (see fig. 93) as a model, made him (the slave) see that the equal triangles in the squares on HB and HA were just as many as like equal tri's in the sq. on AB, as is evident by inspection.

(See Plato's Dialogues, Meno, Vol. I, pp. 256-260, Edition of 1883, Jowett's translation, Chas. Scribner and Sons.)

a. Omitting the lines AK, CB, BE and FA, which eliminates the numbered triangles, there remains the figure which, in Free Masonry, is called the Classic Form, the form usually found on the master's carpet.

b. The following rule is credited to Pythagoras. Let n be any odd number, the short side; square it, and from this square subtract 1; divide the remainder by 2, which gives the median side; add 1 to this quotient, and this sum is the hypotenuse; e.g., 5 = short side; $5^2 - 1 = 24$; $24 \div 2 = 12$, the median side; $12 + 1 = 13$ the hypotenuse. See said Rule of Pythagoras, above, on p. 19.

Ninety-Nine

Starting with fig. 93, and decreasing the length of AH, which necessarily increases the length

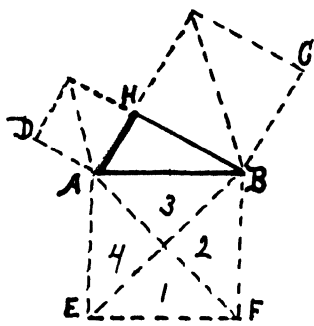


Fig. 94a

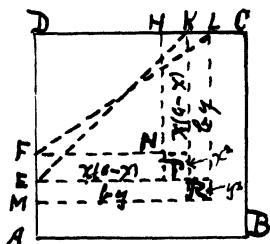


Fig. 94b

$DA = AB = c$
 $DE = DK = a = b$
 $DF = a - x$
 $DL = b + y$
 $FE = HK = x$
 $KL = EM = y$
 $EK = FL = h$

of AH, which necessarily increases the length of HB, since AB remains constant, we decrease the sq. HD and increase the sq. HC (see fig. 94a).

Now we are to prove that the sum of the two variable squares, sq. HD and sq. HC will equal the constant sq. HF.

We have, fig. 94a,
 $h^2 = a^2 + b^2$(1)

But let side AH, fig. 93, be diminished as by x , thus giving AH, fig. 94a, or better, FD, fig. 94b, and let DK be increased by y , as determined by the hypotenuse h remaining constant.

Now, fig. 94b, when $a = b$,
 $a^2 + b^2 = 2$ area of sq. DP. And when $a < b$, we have $(a - x)^2 =$ area of sq. DN, and $(b + y)^2 =$ area of sq. DR.

Also $c^2 - (b + y)^2 = (a - x)^2 =$ area of MABCLR, or
 $(a - x)^2 + (b + y)^2 = c^2$(2)

Is this true? Suppose it is; then, after reducing (2) - (1)
 $= (3) - 2ax + x^2 + 2by + y^2 = 0$,
 or (4) $2ax - x^2 = 2by + y^2$, which shows that the area by which

$(a^2 = \text{sq. DP})$ is diminished = the area by which b^2 is increased. See graph 94b. \therefore the increase always equals the decrease.

But $a^2 - 2x(a - x) - x^2 = (a - x)^2$ approaches 0 when x approaches a in value.

\therefore (5) $(a - x)^2 = 0$, when $x = a$, which is true and (6) $b^2 + 2by + y^2 = (b + y)^2 = c^2$, when $x = a$, for when x becomes a , $(b + y)$ becomes c , and so, we

have $c^2 = c^2$ which is true.

\therefore equation (2) is true; it rests on the eq's (5) and (6), both of which are true.

\therefore whether $a < =$ or $> b$, $h^2 = a^2 + b^2$.

a. Devised by the author, in Dec. 1925. Also a like proof to the above is that of A. R. Colburn, devised Oct. 18, 1922, and is No. 96 in his collection of 108 proofs.

F.--Algebraic-Geometric Proofs

In determining the equivalency of areas these proofs are algebraic; but in the final comparison of areas they are geometric.

One Hundred

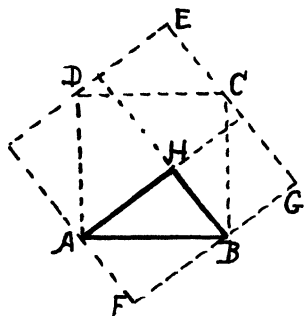


Fig. 95

The construction, see fig. 95, being made, we have sq. FE = $(a + b)^2$.

$$\begin{aligned} \text{But sq. FE} &= \text{sq. AC} \\ &+ 4 \text{ tri. ABH} \\ &= h^2 + 4 \frac{ab}{2} = h^2 + 2ab. \end{aligned}$$

Equating, we have

$$h^2 + 2ab = (a + b)^2 = a^2 + 2ab + b^2. \quad \therefore h^2 = a^2 + b^2.$$

a. See Sci. Am. Sup., V. 70, p. 382, Dec. 10, 1910, credited to A. R. Colburn, Washington, D.C.

One Hundred One

Let $AD = AG = x$, $HG = HC = y$, and $BC = BE = z$. Then $AH = x + y$, and $BH = y + z$.

With A as center and AH as radius describe arc HE; with B as center and BH as radius describe arc HD; with B as center, BE as radius describe arc EC; with A as center, radius AD, describe arc DG.



NICHOLAS COPERNICUS

1473-1543

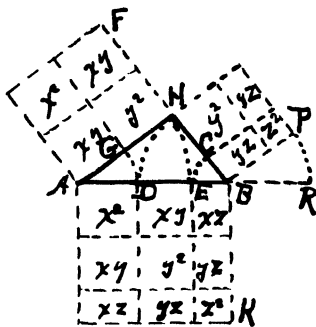


Fig. 96

Draw the parallel lines as indicated. By inspecting the figure it becomes evident that if $y^2 = 2xz$, then the theorem holds. Now, since AH is a tangent and AR is a chord of same circle,

$$AH^2 = AR \times AD, \text{ or } (x + y)^2 = x(2y + 2z) = x^2 + 2xy + 2xz.$$

Whence $y^2 = 2xz$.

$$\begin{aligned} \therefore \text{sq. AK} &= [(x^2 + y^2 + 2xy) \\ &= \text{sq. AL}] + [(z^2 + 2yz + 2xz = y^2)] = \text{sq. HP. } \therefore h^2 \\ &= a^2 + b^2. \end{aligned}$$

a. See Sci. Am. Supt., V. 84, p. 362, Dec. 8, 1917, and credited to A. R. Colburn. It is No. 79 in his (then) 91 proofs.

b. This proof is a fine illustration of the flexibility of geometry. Its value lies, not in a repeated proof of the many times established fact, but in the effective marshaling and use of the elements of a proof, and even more also in the better insight which it gives us to the interdependence of the various theorems of geometry.

One Hundred Two

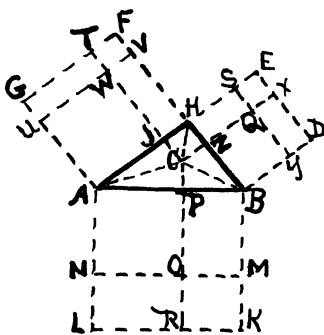


Fig. 97

Draw the bisectors of angles A, B and H, and from their common point C draw the perp's CR, CX and CT; take AN = AU = AP, and BZ = BP, and draw lines UV par. to AH, NM par. to AB and SY par. to BH. Let AJ = AP = x, BZ = BP = y, and HZ = HJ = z = CJ = CP = CZ.

$$\begin{aligned} \text{Now 2 tri. ABH} &= \text{HB} \\ \times \text{HA} &= (x + z)(y + z) = xy \\ &+ xz + yz + z^2 = \text{rect. PM} \\ &+ \text{rect. HW} + \text{rect. HQ} + \text{sq. SX.} \end{aligned}$$

But 2 tri. ABH = $2AP \times CP + 2BP \times CP + (2 \text{ sq. HC} = 2PC^2) = 2xz + 2yz + 2z^2$

$$= 2 \text{ rect. HW} + 2 \text{ rect. HQ} + 2 \text{ sq. SX.}$$

\therefore rect. PM = rect. HW + rect. HQ + sq. KX.

Now sq. AK = (sq. AO = sq. AW) + (sq. OK = sq. BQ) + (2 rect. PM = rect. HW + 2 rect. HQ + 2 sq. SX) = sq. HG + sq. HD. $\therefore h^2 = a^2 + b^2$.

a. This proof was produced by Mr. F. S. Smedley, a photographer, of Berea, O., June 10, 1901.

Also see Jury Wipper, 1880, p. 34, fig. 31, credited to E. Möllmann, as given in "Archives d. Mathematik, u. Ph. Grunert," 1851, for fundamentally the same proof.

One Hundred Three

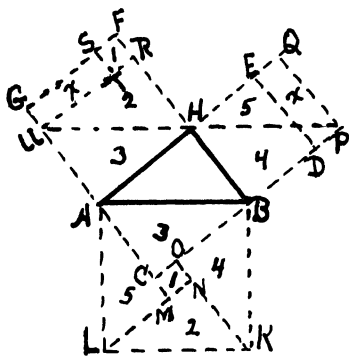


Fig. 98

Let $HR = HE = a = SG$.

Then rect. GT = rect. EP,
and rect. RA = rect. QB.

\therefore tri's 2, 3, 4 and 5 are all equal. \therefore sq. AK = $h^2 = (\text{area of 4 tri. ABH} + \text{area sq. OM}) = 2ba + (b - a)^2 = 2ab + b^2 - 2ba + a^2 = b^2 + a^2$. $\therefore h^2 = a^2 + b^2$. Q.E.D.

a. See Math. Mo., 1858-9, Vol. I, p. 361, where above proof is given by Dr. Hutton (tracts, London, 1812, 3 vol's, 820) in his History of Algebra.

One Hundred Four

Take AN and AQ = AR, KM and KR = BH, and through P and Q draw PM and QL parallel to AB; also draw OR and NS par. to AC. Then $CR = h - a$, $SK = h - b$ and $RS = a + b - h$.

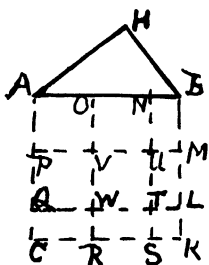


Fig. 99

Now sq. $AK = CK^2 = CS^2 + RK^2$
 $- RS^2 + 2CR \times SK$, or $h^2 = b^2 + a^2$
 $- (a + b - h)^2 + 2(h - a) \times (h - b)$
 $= b^2 + a^2 - a^2 - b^2 - h^2 - 2ab + 2ah$
 $+ 2bh + 2h^2 - ah - 2bh + 2ab$ $\therefore 2CR$
 $\times SK = RS^2$, or $2(h - a)(h - b)$
 $= (a + b - h)^2$, or $2h^2 + 2ab - 2ah$
 $- 2bh = a^2 + b^2 + h^2 + 2ab + 2ah$
 $- 2bh$. $\therefore h^2 = a^2 + b^2$.

a. Original with the author,
 April 23, 1926.

G.--Algebraic-Geometric Proofs Through Similar Polygons Other Than Squares.

1st.--Similar Triangles

One Hundred Five

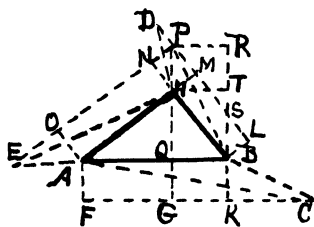


Fig. 100

Tri's ACB, BDH and HEA are three similar tri's constructed upon AB, BH and HA, and AK, BM and HO are three corresponding rect's, double in area to tri's ACB, BDH and HEA respectively.

Tri. ACB : tri. BDH
 : tri. HEA = $h^2 : a^2 : b^2$
 $= 2 \text{ tri. ACB} : 2 \text{ tri. BDA}$
 $= 2 \text{ tri. HEA} = \text{rect. AK}$

: rect. BM : rect. HO. Produce LM and ON to their intersection P, and draw PHG. It is perp. to AB, and by the Theorem of Pappus, see fig. 143, PH = QG. \therefore , by said theorem, rect. BM + rect. HO = rect. AK. \therefore tri. BDH + tri. HEA = tri. ACB. $\therefore h^2 = a^2 + b^2$.

a. Devised by the author Dec. 7, 1933.

One Hundred Six

In fig. 100 extend KB to R, intersecting LM at S, and draw PR and HT par. to AB. Then rect. BLMH = paral. BSPH = 2 tri. BPH = 2 tri(BPH = PH \times QB) = rect. QK. In like manner, 2 tri. HEA = rect. AG.

Now tri. ABH : tri. BHQ : tri. HAQ = $h^2 : a^2 : b^2$
 = tri. ACB : tri. BDH : tri. HEA.

But tri. ABH = tri. BHQ + tri. HAQ. \therefore tri.
 ACB = tri. BDH + tri. HEA. $\therefore h^2 = a^2 + b^2$. Q.E.D.

a. Devised by author Dec. 7, 1933.

One Hundred Seven

Since in any triangle with sides a , b and c -- c being the base, and h' the altitude--the formula for h' is:

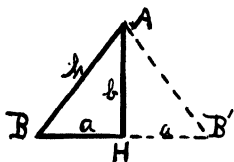


Fig. 101

$$h'^2 = \frac{2s \times 2(s-a) \times 2(s-b) \times 2(s-c)}{4c'^2}$$

and having, as here, $c' = 2a$, $h' = b$,
 $a' = b' = h$, by substitution in
 formula for h'^2 , we get, after re-

ducing, $b^2 = h^2 - a^2$. $\therefore h^2 = a^2 + b^2$.

a. See Versluys, p. 86, fig. 96, where, taken from "De Vriend des Wiskunde" it is attributed to J. J. Posthumus.

2nd.--Similar Polygons of More Than Four Sides.

Regular Polygons

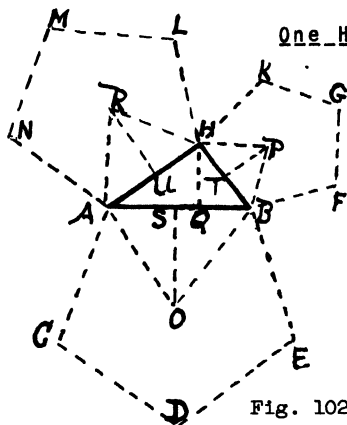


Fig. 102

One Hundred Eight

Any regular polygons can be resolved into as many equal isosceles tri's as the polygon has sides. As the tri's are similar tri's so whatever relations are established among these tri's AOB, BPH and HRA, the same relations will exist among the polygons O, P and R.

As tri's AOB, BPH and HRA are similar isosceles tri's, it follows that these tri's are a particular case of proof One Hundred Six.

And as tri. ABH : tri. BHQ : tri. HAQ = h^2 : a^2 : b^2 = tri. AOB : tri. BPH : tri. HRA = pentagon O : pentagon P : pentagon R, since tri. ABH = tri. BHQ + tri. HAQ. \therefore polygon O = polygon P + polygon R. $\therefore h^2 = a^2 + b^2$.

a. Devised by the author Dec. 7, 1933.

One Hundred Nine

Upon the three sides of the rt. tri. ABH are constructed the three similar polygons (having five or more sides--five in fig. 103), ACDEB, BFGKH and HLMNA. Prove algebraically that $h^2 = a^2 + b^2$, through proving that the sum of the areas of the two lesser polygons = the area of the greater polygon.

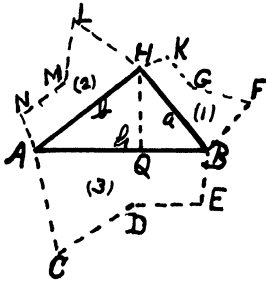


Fig. 103

In general, an algebraic proof is impossible before transformation. But granting that $h^2 = a^2 + b^2$, it is easy to prove that polygon (1) + polygon (2) = polygon (3), as we know that polygon (1) : polygon (2) : polygon (3) = a^2 : b^2 : h^2 . But from this it does not follow that $a^2 + b^2 = h^2$.

See Beman and Smith's *New Plane and Solid Geometry* (1899), p. 211, exercise 438.

But an algebraic proof is always possible by transforming the three similar polygons into equivalent similar paral's and then proceed as in proof One Hundred Six.

Knowing that tri. ABH : tri. BHQ : tri. HAQ = h^2 : a^2 : b^2 . ---(1)

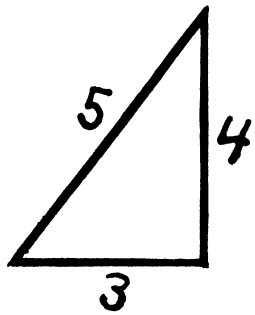
and that P. (3) : P. (1) : P. (2). [P = polygon] = h^2 : a^2 : b^2 . ---(2); by equating tri. ABH : tri. BHQ : tri. HAQ = P. (3) : P. (1) : P. (2). But

tri. ABH = tri. BHQ + tri. HAQ. \therefore P. (3) = P. (1)
+ P. (2). $\therefore h^2 = a^2 + b^2$. Q.E.D.

a. Devised by the author Dec. 7, 1933.

b. Many more algebraic proofs are possible.

To evolve an original demonstration and put it in a form free from criticism is not the work of a tyro.



II. GEOMETRIC PROOFS

All geometric demonstrations must result from the comparison of areas--the foundation of which is superposition.

As the possible number of algebraic proofs has been shown to be limitless, so it will be conclusively shown that the possible number of geometric proofs through dissection and comparison of congruent or equivalent areas is also "absolutely unlimited."

The geometric proofs are classified under ten type forms, as determined by the figure, and only a limited number, from the indefinite many, will be given; but among those given will be found all heretofore (to date, June 1940), recorded proofs which have come to me, together with all recently devised or new proofs.

The references to the authors in which the proof, or figure, is found or suggested, are arranged chronologically so far as possible.

The idea of throwing the suggested proof into the form of a single equation is my own; by means of it every essential element of the proof is set forth, as well as the comparison of the equivalent or equal areas.

The wording of the theorem for the geometric proof is: *The square described upon the hypotenuse of a right-angled triangle is equal to the sum of the squares described upon the other two sides.*

TYPES

It is obvious that the three squares constructed upon the three sides of a right-angled triangle can have eight different positions, as per selections. Let us designate the square upon the

hypotenuse by h , the square upon the shorter side by a , and the square upon the other side by b , and set forth the eight arrangements; they are:

- A. All squares h , a and b exterior.
- B. a and b exterior and h interior.
- G. h and a exterior and b interior.
- D. h and b exterior and a interior.
- E. a exterior and h and b interior.
- F. b exterior and h and a interior.
- G. h exterior and a and b interior.
- H. All squares h , a and b interior.

The arrangement designated above constitute the first eight of the following ten geometric types, the other two being:

- I. A translation of one or more squares.
- J. One or more squares omitted.

Also for some selected figures for proving Euclid I, Proposition 47, the reader is referred to H. d'Andre, N. H. Math. (1846), Vol. 5, p. 324.

Note. By "exterior" is meant constructed outwardly.

By "interior" is meant constructed overlapping the given right triangle.

A

This type includes all proofs derived from the figure determined by constructing squares upon each side of a right-angled triangle, each square being constructed outwardly from the given triangle.

The proofs under this type are classified as follows:

(a) Those proofs in which pairs of the dissected parts are congruent.

Congruency implies superposition, the most fundamental and self-evident truth found in plane geometry.

As the ways of dissection are so various, it follows that the number of "dissection proofs" is unlimited.

(b) Those proofs in which pairs of the dissected parts are shown to be equivalent.

As geometers at large are not in agreement as to the symbols denoting "congruency" and "equivalency" (personally the author prefers \cong for congruency, and $=$ for equivalency), the symbol used herein shall be $=$, the context deciding its import.

(a) PROOFS IN WHICH PAIRS OF THE DISSECTED PARTS ARE CONGRUENT.

Paper Folding "Proofs," Only Illustrative

One

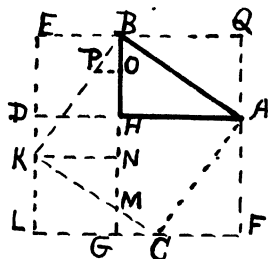


Fig. 104

Cut out a square piece of paper EF, and on its edge, using the edge of a second small square of paper, EH, as a measure, mark off EB, ED, LK, LG, FC and QA.

Fold on DA, BG, KN, KC, CA, AB and BK. Open the sq. EF and observe three sq's, EH, HF and BC, and that sq. EH = sq. KG.

With scissors cut off tri. CFA from sq. HF, and lay it on sq. BC in position BHA, observing that it covers tri. BHA of sq. BC;

next cut off KLC from sq's NL and HF and lay it on sq. BC in position of KNB so that MG falls on PO. Now observe that tri. KMN is part of sq. KG and sq. BC and that the part HMCA is part of sq. HF and sq. BC, and that all of sq. BC is now covered by the two parts of sq. KG and the two parts of sq. HF.

Therefore the (sq. EH = sq. KG) + sq. HF = the sq. BC. Therefore the sq. upon the side BA which is sq. BC = the sq. upon the side BH which is

sq. BD + the sq. upon the side HA which is sq. HF.
 $\therefore h^2 = a^2 + b^2$, as shown with paper and scissors,
and observation.

a. See "Geometric Exercises in Paper Folding," (T. Sundra Row's), 1905, p. 14, fig. 13, by Beman and Smith; also School Visitor, 1882, Vol. III, p. 209; also F. C. Boon, B.H., in "A Companion to Elementary School Mathematics," (1924), p. 102, proof 1.

Two

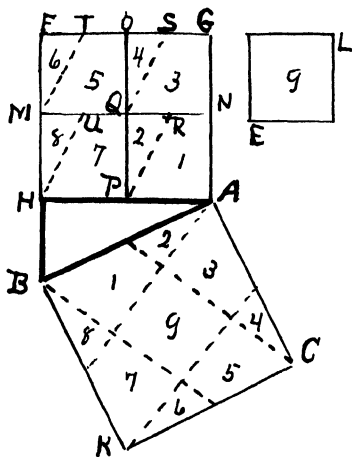


Fig. 105

Cut out three sq's EL whose edge is HB, FA whose edge HA, and BC whose edge is AB, making $AH = 2HB$.

Then fold sq. FA along MN and OP, and separate into 4 sq's MP, QA, ON and FQ each equal to sq. EL.

Next fold the 4 paper sq's (U, R, S and T being middle pt's), along HU, PR, QS and MT, and cut, forming parts, 1, 2, 3, 4, 5, 6, 7 and 8.

Now place the 8 parts on sq. BC in positions as indicated, reserving sq. 9 for last place. Observe that sq. FA and EL

exactly cover sq. BC. \therefore sq. upon BA = sq. upon (HB = EL) + sq. upon AH. $\therefore h^2 = a^2 + b^2$. Q.E.F.

a. Beman and Smith's Row's (1905), work, p. 15, fig. 14; also School Visitor, 1882, Vol. III, p. 208; also F. C. Boon, p. 102, proof 1.

Three

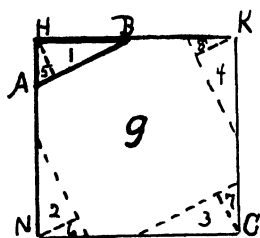


Fig. 106

Cut out three sq's as in fig. 105. Fold small sq. 9 (fig. 105) along middle and cut, forming 2 rect's; cut each rect. along diagonal, forming 4 rt. tri's, 1, 2, 3 and 4. But from each corner of sq. FA (fig. 105), a rt. tri. each having a base HL = $\frac{1}{2}$ HP (fig. 105; FT = $\frac{1}{2}$ FM), giving 4 rt. tri's 5, 6, 7 and 8 (fig. 106), and a center part 9 (fig. 106), and arrange the pieces as in fig. 106, and observe that sq. HC = sq. EL + sq. HG, as in fig. 105. $\therefore h^2 = a^2 + b^2$.

a. See "School Visitor," 1882, Vol. III, p. 208.

b. Proofs Two and Three are particular and illustrative--not general--but useful as a paper and scissors exercise.

c. With paper and scissors, many other proofs, true under all conditions, may be produced, using figs. 110, 111, etc., as models of procedure.

Four

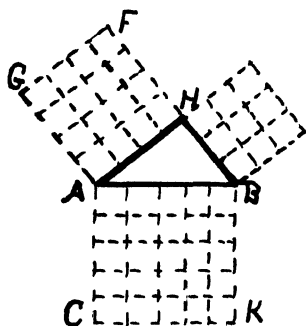


Fig. 107

Particular case--illustrative rather than demonstrative.

The sides are to each other as 3, 4, 5 units. Then sq. AK contains 25 sq. units, HD 9 sq. units and HG 16 sq. units. Now it is evident that the no. of unit squares in the sq. AK = the sum of the unit squares in the squares HD and HG.

\therefore square AK = sq. HD + sq. HG.

a. That by the use of the lengths 3, 4, and 5, or length having the ratio of 3 : 4 : 5, a right-angled triangle is formed was known to the Egyptians as early as 2000 B.C., for at that time there existed professional "rope-fasteners"; they were employed to construct right angles which they did by placing three pegs so that a rope measuring off 3, 4 and 5 units would just reach around them. This method is in use today by carpenters and masons; sticks 6 and 8 feet long form the two sides and a "ten-foot" stick forms the hypotenuse, thus completing a right-angled triangle, hence establishing the right angle.

But granting that the early Egyptians formed right angles in the "rule of thumb" manner described above, it does not follow, in fact it is not believed, that they knew the area of the square upon the hypotenuse to be equal to the sum of the areas of the squares upon the other two sides.

The discovery of this fact is credited to Pythagoras, a renowned philosopher and teacher, born at Samos about 570 B.C., after whom the theorem is called "The Pythagorean Theorem." (See p. 3).

b. See Hill's *Geometry for Beginners*, p. 153; Ball's *History of Mathematics*, pp. 7-10; Heath's *Math. Monographs*, No. 1, pp. 15-17; *The School Visitor*, Vol. 20, p. 167.

Five

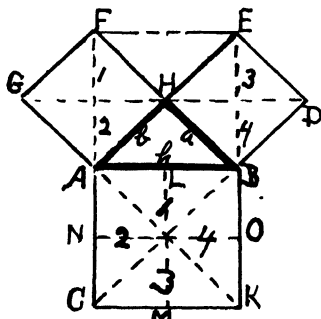


Fig. 108

Another particular case is illustrated by fig. 108, in which $BH = HA$, showing 16 equal triangles.

Since the sq. AK contains 8 of these triangles, \therefore sq. AK = sq. HD + sq. HG. $\therefore h^2 = a^2 + b^2$.

a. For this and many other demonstrations by dissection, see H. Perigal, in *Messenger of Mathematics*,

1873, V. 2, p. 103; also see Fourrey, p. 68.

b. See Beman and Smith's *New Plane and Solid Geometry*, p. 103, fig. 1.

c. Also R. A. Bell, Cleveland, O., using sq. AK and lines AK and BC only.

Six

In fig. 108, omit lines AF, BE, LM and NO, and draw line FE; this gives the fig. used in "Grand Lodge Bulletin," Grand Lodge of Iowa, A.F. and A.M., Vol. 30, Feb. 1929, No. 2, p. 42. The proof is obvious, for the 4 equal isosceles rt. tri's which make up sq. FB = sq. AK. $\therefore h^2 = a^2 + b^2$.

a. This gives another form for a folding paper proof.

Seven

In fig. 108, omit lines as in proof Six, and it is obvious that tri's 1, 2, 3 and 4, in sq's HG and HD will cover tri's 1, 2, 3 and 4 in sq. AK, or sq. AK = sq. HD + sq. HG. $\therefore h^2 = a^2 + b^2$.

a. See Versluys (1914), fig. 1, p. 9 of his 96 proofs.

Eight

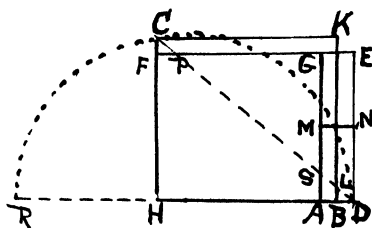


Fig. 109

In fig. 109, let HAGF denote the larger sq. HG. Cut the smaller sq. EL into two equal rectangles AN and ME, fig. 109, and form with these and the larger sq. the rect. HDEF. Produce DH so that HR = HF. On RD as a diameter describe a semicircle DCR. Produce

HF to C in the arc. Join CD, cutting FG in P, and AG in S. Complete the sq. HK.

Now tri's CPF and LBD are congruent as are tri's CKL and PED. Hence sq. KH = (sq. EL, fig. 105 = rect. AN + rect. ME, fig. 109) + (sq. HG, fig. 105 = quad. HASPF + tri. SGP, fig. 109). $\therefore h^2 = a^2 + b^2$.

a. See School Visitor, 1882, Vol. III, p. 208.

b. This method, embodied in proof Eight, will transform any rect. into a square.

c. Proofs Two to Eight inclusive are illustrative rather than demonstrative.

Demonstrative Proofs

Nine

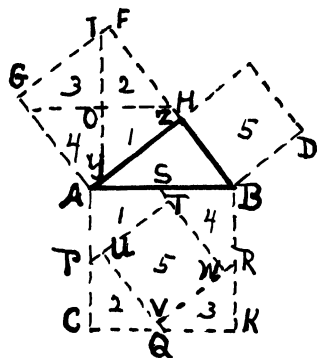


Fig. 110

(Sq. AK = 4 quad. APTS + sq. TV) = (sq. HG = 4 quad. OYHZ) + sq. HD. \therefore sq. on AB = sq. on BH + sq. on AH. $\therefore h^2 = a^2 + b^2$.

a. See Mess. Math., Vol. 2, 1873, p. 104, by Henry Perigal, F. R. A. S., etc., Macmillan and Co., London and Cambridge. Here H. Perigal shows the great value of proof by dissection, and suggests its application to other theorems also. Also see Jury

In fig. 110, through P, Q, R and S, the centers of the sides of the sq. AK draw PT and RV par. to AH, and QU and SW par. to BH, and through O, the center of the sq. HG, draw XH par. to AB and IY par. to AC, forming 8 congruent quadrilaterals; viz., 1, 2, 3 and 4 in sq. AK, and 1, 2, 3 and 4 in sq. HG, and sq. 5 in sq. AK = sq. (5 = HD). The proof of their congruency is evident, since, in the paral. OB, (SB = SA) = (OH = OG = AP since AP = AS).

Wipper, 1880, p. 50, fig. 46; Ebene Geometrie, Von G. Mahler, Leipzig, 1897, p. 58, fig. 71, and School Visitor, V. III, 1882, p. 208, fig. 1, for a particular application of the above demonstration; Versluys, 1914, p. 37, fig. 37 taken from "Plane Geometry" of J. S. Mackay, as given by H. Perigal, 1830; Fourrey, p. 86; F. C. Boon, proof 7, p. 105; Dr. Leitzmann, p. 14, fig. 16.

b. See Todhunter's Euclid for a simple proof extracted from a paper by De Morgan, in Vol. I of the Quarterly Journal of Math., and reference is also made there to the work "Der Pythagoraische Lehrsatz," Mainz, 1821, by J. J. I. Hoffmann.

c. By the above dissection any two squares may be transformed into one square, a fine puzzle for pupils in plane geometry.

d. Hence any case in which the three squares are exhibited, as set forth under the first 9 types of II, Geometric Proofs, A to J inclusive (see Table of Contents for said types) may be proved by this method.

c. Proof Nine is unique in that the smaller sq. HD is not dissected.

Ièn

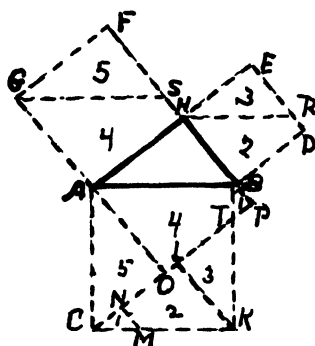


Fig. 111

In fig. 111, on CK construct tri. CKL = tri. ABH; produce CL to P making LP = BH and take LN = BH; draw NM, AO and BP each perp. to CP; at any angle of the sq. GH, as F, construct a tri. GSF = tri. ABH, and from any angle of the sq. HD, as H, with a radius = KM, determine the pt. R and draw HR, thus dissecting the sq's, as per figure.

It is readily shown

that sq. AK = (tri. CMN = tri. BTP) + (trap. NMKL = trap. DRHB) + (tri. KTL = tri. HRE) + (quad. AOTB + tri. BTP = trap. GAHS) + (tri. ACO = tri. GSF) = (trap. DRHB + tri. HRE = sq. BE) + (trap. GAHS + tri. GSF = sq. AF) = sq. BE + sq. AF. \therefore sq. upon AB = sq. upon BH + sq. upon AH. $\therefore h^2 = a^2 + b^2$.

a. This dissection and proof were devised by the author, on March 18, 1926, to establish a Law of Dissection, by which, no matter how the three squares are arranged, or placed, their resolution into the respective parts as numbered in fig. 111, can be readily obtained.

b. In many of the geometric proofs herein the reader will observe that the above dissection, wholly or partially, has been employed. Hence these proofs are but variation of this general proof.

Eleven

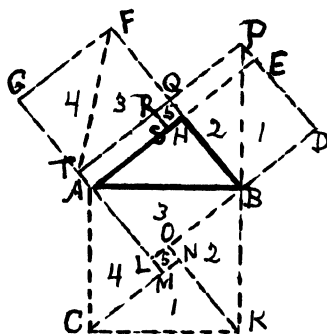


Fig. 112

In fig. 112, conceive rect. TS cut off from sq. AF and placed in position of rect. QE, AS coinciding with HE; then DEP is a st. line since these rect. were equal by construction. The rest of the construction and dissection is evident.

sq. AK = (tri. CKN = tri. PBD) + (tri. KBO = tri. BPQ) + (tri. BAL = tri. TFQ) + (tri. ACM = tri. FTG)

+ (sq. LN = sq. RH) = sq. BE + rect. QE + rect. GQ + sq. RH = sq. BE + sq. GH. \therefore sq. upon AB = sq. upon BH + sq. upon AH. $\therefore h^2 = a^2 + b^2$.

a. Original with the author after having carefully analyzed the esoteric implications of Bhaskara's "Behold!" proof--see proof Two Hundred Twenty-Four, fig. 325.

b. The reader will notice that this dissection contains some of the elements of the preceding dissection, that it is applicable to all three-square figures like the preceding, but that it is not so simple or fundamental, as it requires a transposition of one part of the sq. GH,--the rect. TS--, to the sq. HD,--the rect. in position QE--, so as to form the two congruent rect's GQ and QD.

c. The student will note that all geometric proofs hereafter, which make use of dissection and congruency, are fundamentally only variations of the proofs established by proofs Nine, Ten and Eleven and that all other geometric proofs are based, either partially or wholly on the equivalency of the corresponding pairs of parts of the figures under consideration.

Twelve

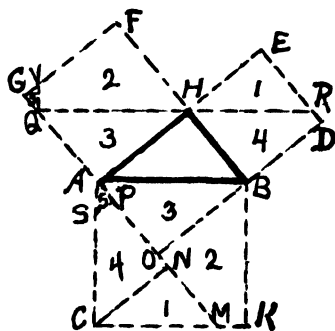


Fig. 113

This proof is a simple variation of the proof Ten above. In fig. 113, extend GA to M, draw CN and BO perp. to AM, take NP = BD and draw PS par. to CN, and through H draw QR par. to AB. Then since it is easily shown that parts 1 and 4 of sq. AK = parts 1 and 4 of sq. HD, and parts 2 and 3 of sq. AK = 2 and 3 of sq. HG, \therefore sq. upon AB = sq. upon BH + sq. upon AH.

a. Original with the author March 28, 1926 to obtain a figure more readily constructed than fig. 111.

b. See School Visitor, 1882, Vol. III, p. 208-9; Dr. Leitzmann, p. 15, fig. 17, 4th Ed'n.

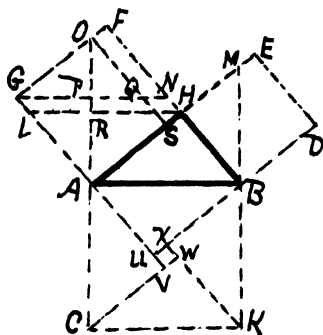
Thirteen

Fig. 114

In fig. 114, produce CA to O, KB to M, GA to V, making AV = AG, DB to U, and draw KX and CW par. resp. to BH and AH, GN and HL par. to AB, and OT par. to FB.

$$\begin{aligned} \text{Sq. AK} &= [\text{tri. CKW} = \text{tri. (HLA} = \text{trap. BDEM} + \text{tri. NST)}] \\ &+ [\text{tri. KBX} = \text{tri. GNF} \\ &= (\text{trap. OQNF} + \text{tri. BMH})] \\ &+ (\text{tri. BAU} = \text{tri. OAT}) \\ &+ (\text{tri. ACV} = \text{tri. AOG}) \\ &+ (\text{sq. VX} = \text{paral. SN}) \\ &= \text{sq. BE} + \text{sq. HG. } \therefore \text{sq.} \end{aligned}$$

upon AB = sq. upon BH + sq. upon AH. $\therefore h^2 = a^2 + b^2$.

a. Original with author March 28, 1926, 9:30

p.m.

b. A variation of the proof Eleven above.

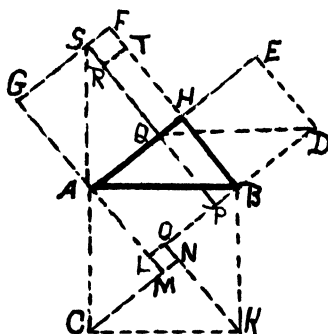
Fourteen

Fig. 115

Produce CA to S, draw SP par. to FB, take HT = HB, draw TR par. to HA, produce GA to M, making AM = AG, produce DB to L, draw KO and CN par. resp. to BH and AH, and draw QD. Rect. RH = rect. QB. Sq. AK

$$\begin{aligned} &= (\text{tri. CKN} = \text{tri. ASG}) \\ &+ (\text{tri. KBO} = \text{tri. SAQ}) \\ &+ (\text{tri. BAL} = \text{tri. DQP}) \\ &+ (\text{tri. ACM} = \text{tri. QDE}) \\ &+ (\text{sq. LN} = \text{sq. ST}) = \text{rect.} \\ &\text{PE} + \text{rect. GQ} + \text{sq. ST} = \text{sq.} \\ &\text{BE} + \text{rect. QB} + \text{rect. GQ} \end{aligned}$$

+ sq. ST = sq. BE + sq. GH. \therefore sq. upon AB = sq. upon BH + sq. upon AH. $\therefore h^2 = a^2 + b^2$.

- a. Original with author March 28, 1926, 10 a.m.
 b. This is another variation of fig. 112.

Fifteen

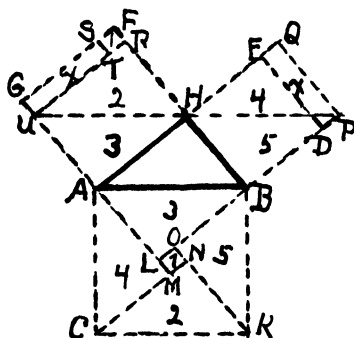


Fig. 116

Take $HR = HE$ and $FS = FR = EQ = DP$.

Draw RU par. to AH , ST par. to FH , QP par. to BH , and UP par. to AB . Extend GA to M , making $AM = AG$, and DB to L and draw CN par. to AH and KO par. to BH .

Place rect. GT in position of EP . Obvious that: $Sq. AK =$ parts $(1 + 2 + 3) + (4 + 5$ of rect. $HP)$. $\therefore Sq.$ upon $AB = sq.$ upon $BH + sq.$ upon AH .
 $\therefore h^2 = a^2 + b^2$.

a. Math. Mo., 1858-9, Vol. I, p. 231, where this dissection is credited to David W. Hoyt, Prof. Math. and Mechanics, Polytechnic College, Phila., Pa.; also to Pliny Earle Chase, Phila., Pa.

b. The Math. Mo. was edited by J. D. Runkle, A.M., Cambridge Eng. He says this demonstration is essentially the same as the Indian demonstration found in "Bija Gaita" and referred to as the figure of "The Brides Chair."

c. Also see said Math. Mo., p. 361, for another proof; and Dr. Hutton (tracts, London, 1812, in his History of Algebra).

Sixteen

In fig. 117, the dissection is evident and shows that parts 1, 2 and 3 in sq. AK are congruent to parts 1, 2 and 3 in sq. HG ; also that parts 4 and

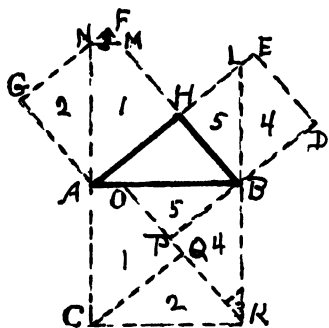


Fig. 117

p. 17, 27th proof, by C. W. Tyron, Louisville, Ky.; Beman and Smith's *Plane and Solid Geom.*, 1895, p. 88, fig. 5; *Am. Math. Mo.*, V. IV, 1897, p. 169 proof XXXIX; and Heath's *Math. Monographs*, No. 2, p. 33, proof XXII. Also *The School Visitor*, V. III, 1882, p. 209, for an application of it to a particular case; Fourrey, p. 87, by Ozanam, 1778, R. Wolf, 1869.

b. See also "Recreations in Math. and Physics," by Ozanam; "Curiosities of Geometry," 1778, by Zie E. Fourrey; M. Kröger, 1896; Versluys, p. 39, fig. 39, and p. 41, fig. 41, and a variation is that of Versluys (1914), p. 40, fig. 41.

Seventeen

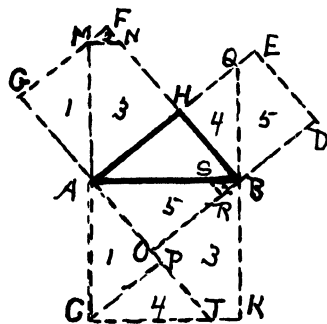


Fig. 118

5 in sq. AK are congruent to parts 4 and 5 in sq. HD.

\therefore (sq. AK = parts 1 + 2 + 3 + 4 + 5) = (sq. HG = parts 1 + 2 + 3) + (sq. HD = parts 4 + 5). \therefore sq. on AB = sq. on BH + sq. on AH. $\therefore h^2 = a^2 + b^2$.

a. See Jury Wipper, 1880, p. 27, fig. 24, as given by Dr. Rudolf Wolf in "Handbook der Mathematik, etc.," 1869; *Journal of Education*, V. XXVIII, 1888,

Extend CA to M and KB to Q, draw MN par. to AB. Extend GA to T and DB to O. Draw CP par. to AB. Take OR = HB and draw RS par. to HB.

Obvious that sq. AK = sum of parts (4 + 5) + (1 + 2 + 3) = sq. HD + sq. HG. \therefore sq. upon AB = sq. upon BH + sq. upon HA. $\therefore h^2 = a^2 + b^2$. Q.E.D.

a. Conceived by the author, at Nashville, O., March 26, 1933, for a high school girl there, while present for the funeral of his cousin; also see School Visitor, Vol. 20, p. 167.

b. Proof and fig. 118, is practically the same as proof Sixteen, fig. 117.

On Dec. 17, 1939, there came to me this: Der Pythagoreische Lehrsatz von Dr. W. Leitzmann, 4th Edition, of 1930 (1st Ed'n, 1911, 2nd Ed'n, 1917, 3rd Ed'n,), in which appears no less than 23 proofs of the Pythagorean Proposition, of which 21 were among my proof herein.

This little book of 72 pages is an excellent treatise, and the bibliography, pages 70, 71, 72, is valuable for investigators, listing 21 works re this theorem.

My manuscript, for 2nd edition, credits this work for all 23 proof therein, and gives, as new proof, the two not included in the said 21.

Eighteen

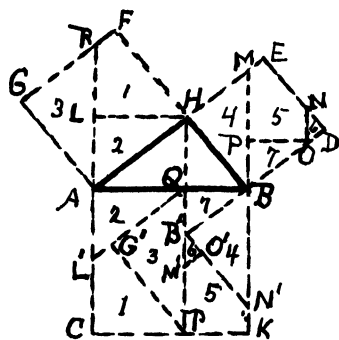


Fig. 119

In fig. 119, the dissection is evident and shows that parts 1, 2 and 3 in sq. HG are congruent to parts 1, 2 and 3 in rect. QC; also that parts 4, 5, 6 and 7 in sq. HD are congruent to parts 4, 5, 6 and 7 in rect. QR.

Therefore, sq. upon AB = sq. upon HB + sq. upon HA. $\therefore h^2 = a^2 + b^2$. Q.E.D.

a. See dissection, Tafel II, in Dr. W. Leitzmann's work, 1930 ed'n--on last leaf of said work. Not

credited to any one, but is based on H. Dobriner's proofs.

Nineteen

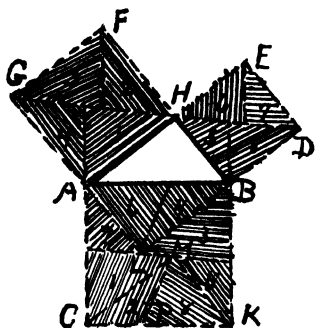


Fig. 120

in fig. 120 draw GD , and from F and E draw lines to GD par. to AC ; then extend DB and GA , forming the rect. AB ; through C and K draw lines par. respectively to AH and BH , forming tri's equal to tri. ABH . Through points L and M draw line par. to GD . Take $KP = BD$, and draw MP , and through L draw a line par. to MP .

Number the parts as in the figure. It is obvious that the dissected sq's HG and HD , giving 8 triangles, can be arranged in sq. AK as numbered; that is, the 8 tri's in sq. AK can be superimposed by their 8 equivalent tri's in sq's HG and HD . \therefore sq. $AK = \text{sq. } HD + \text{sq. } HG$.

$\therefore h^2 = a^2 + b^2$. Q.E.D.

a. See dissection, Tafel I, in Dr. W. Leitzmann work, 1930 ed'n, on 2nd last leaf. Not credited to any one, but is based on J. E. Böttcher's work.

Twenty

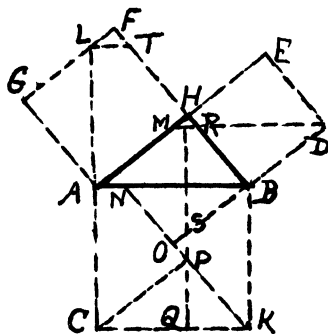


Fig. 121

In fig. 121 the construction is readily seen, as also the congruency of the corresponding dissected parts, from which sq. AK

$$= (\text{quad. } CPNA = \text{quad. } LAHT) + (\text{tri. } CKP = \text{tri. } ALG) + (\text{tri. } BOK = \text{quad. } DEHR + \text{tri. } TFL) + (\text{tri. } NOB = \text{tri. } RBD).$$

\therefore sq. upon $AB = \text{sq. upon } BH + \text{sq. upon } AH$.

a. See Math. Mo., V. IV, 1897, p. 169, proof XXXVIII.

Twenty-One

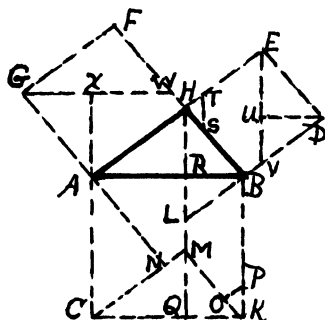


Fig. 122

The construction and dissection of fig. 122 is obvious and the congruency of the corresponding parts being established, and we find that $\text{sq. AK} = (\text{quad. ANMR} = \text{quad. AHWX}) + (\text{tri. CNA} = \text{tri. WFG}) + (\text{tri. CQM} = \text{tri. AXG}) + (\text{tri. MQK} = \text{tri. EDU}) + (\text{tri. POK} = \text{tri. THS}) + (\text{pentagon BLMOP} = \text{pentagon ETSBV}) + (\text{tri. BRL} = \text{tri. DUV})$. $\therefore \text{sq. upon AB} = \text{sq. upon BH} + \text{sq. upon AH}$. $\therefore h^2 = a^2 + b^2$.

a. Original with the author of this work, August 9, 1900. Afterwards, on July 4, 1901, I found same proof in Jury Wipper, 1880, p. 28, fig. 25, as given by E. von Littrow in "Popularen Geometrie," 1839; also see Versluys, p. 42, fig. 43.

Twenty-Two

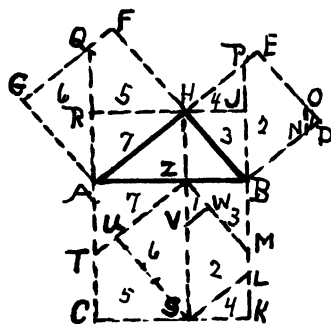


Fig. 123

Extend CA to Q, KB to P, draw RJ through H, par. to AB, HS perp. to CK, SU and ZM par. to BH, SL and ZT par. to AH and take SV = BP, DN = PE, and draw VW par. to AH and NO par. to BP.

Sq. AK = parts (1 + 2 + 3 + 4 = sq. HD) + parts (5 + 6 + 7 = sq. HG); so dissected parts of sq. HD + dissected parts of sq. HG (by superposition), equals the dissected parts of sq. AK.

\therefore Sq. upon AB = sq. upon BH + sq. upon AH.
 $\therefore h^2 = a^2 + b^2$. Q.E.D.

a. See Versluys, p. 43, fig. 44.

b. Fig. and proof, of Twenty-Two is very much like that of Twenty-One.

Twenty-Three

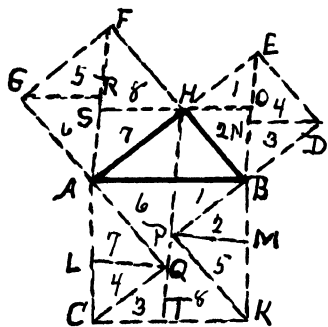


Fig. 124

After showing that each numbered part found in the sq's HD and HG is congruent to the corresponding numbered part in sq. AK, which is not difficult, it follows that the sum of the parts in sq. AK = the sum of the parts of the sq. HD + the sum of the parts of the sq. HG.

\therefore the sq. upon AK
 = the sq. upon HD + the sq. upon HA. $\therefore h^2 = a^2 + b^2$.
 Q.E.D.

a. See Geom. of Dr.

H. Dobriner, 1898; also Versluys, p. 45, fig. 46, from Chr. Nielson; also Leitzmann, p. 13, fig. 15, 4th Ed'n.

Twenty-Four

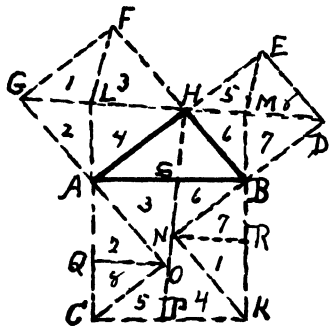


Fig. 125

Proceed as in fig. 124 and after congruency is established, it is evident that, since the eight dissected parts of sq. AK are congruent to the corresponding numbered parts found in sq's HD and HG, parts (1 + 2 + 3 + 4 + 5 + 6 + 7 + 8 in sq. AK) = parts (5 + 6 + 7 + 8) + (1 + 2 + 3 + 4) in sq's HB and HG.

\therefore sq. upon AB = sq. upon HD + sq. upon HA.
 $\therefore h^2 = a^2 + b^2$.

a. See Paul Epstein's (of Straatsberg), collection of proofs; also Versluys, p. 44, fig. 45; also Dr. Leitzmann's 4th ed'n, p. 13, fig. 14.

Twenty-Five

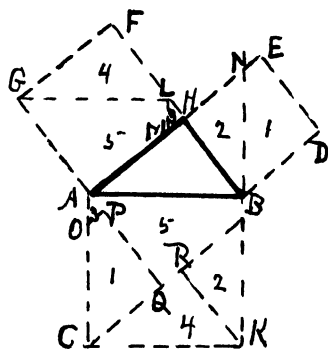


Fig. 126

Establish congruency of corresponding parts; then it follows that: sq. AK (= parts 1 and 2 of sq. HD + parts 3, 4 and 5 of sq. HG) = sq. HD + sq. HG. \therefore sq. upon AB = sq. upon HD + sq. upon HA. $\therefore h^2 = a^2 + b^2$.
 Q.E.D.

a. See Versluys, p. 38, fig. 38. This fig. is similar to fig. 111.

Twenty-Six

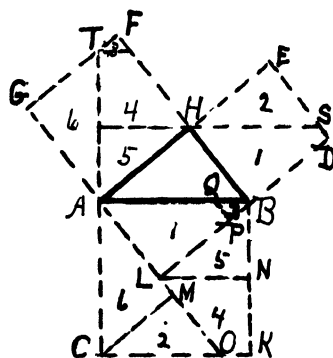


Fig. 127

Since parts 1 and 2 of sq. HD are congruent to like parts 1 and 2 in sq. AK, and parts 3, 4, 5 and 6 of sq. HG to like parts 3, 4, 5 and 6 in sq. AK. \therefore sq. upon AB = sq. upon HB + sq. upon HA. $\therefore h^2 = a^2 + b^2$.
 Q.E.D.

a. This dissection by the author, March 26, 1933.

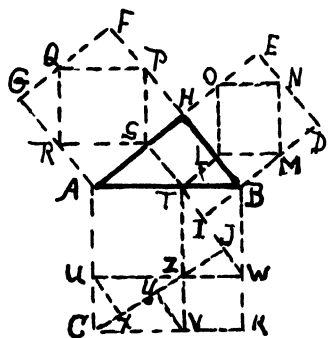
Twenty-Seven

Fig. 128

Take AU and CV = BH and draw UW par. to AB and VT par. to BK; from T draw TL par. to AH and TS par. to BH, locating pts. L and S; complete the sq's LN and SQ, making sides SR and LM par. to AB. Draw SW par. to HB and CJ par. to AH. The 10 parts found in sq's HD and HG are congruent to corresponding parts in sq. AK. \therefore the sq. upon AB = sq. upon HB + sq. upon HA. $\therefore h^2 = a^2 + b^2$. Q.E.D.

a. This proof, and dissection, was sent to me by J. Adams, Chassestreet 31, The Hague, Holland, April 1933.

b. All lines are either perp. or par. to the sides of the tri. ABH--a unique dissection.

c. It is a fine paper and scissors exercise.

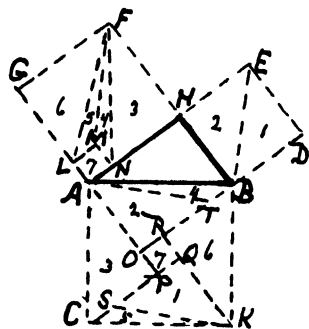
Twenty-Eight

Fig. 129

Draw AF and BE; produce GA to P making AP = AG; produce DB to O; draw CQ par. to AH and KR par. to BH; construct sq. LN = sq. OQ; draw FL and FN; take AT and KS = to FM. Congruency of corresponding numbered parts having been established, as is easily done, it follows that: sq. upon AB = sq. upon HB + sq. upon HA. $\therefore h^2 = a^2 + b^2$. Q.E.D.

a. Benijr von Gutheil, oberlehrer at Nurnberg, Germany, produced the above proof. He died in the trenches in France, 1914. So wrote J. Adams (see a, fig. 128), August 1933.

b. Let us call it the B. von Gutheil World War Proof.

c. Also see Dr. Leitzmann, p. 15, fig. 18, 1930 ed'n.

Twenty-Nine

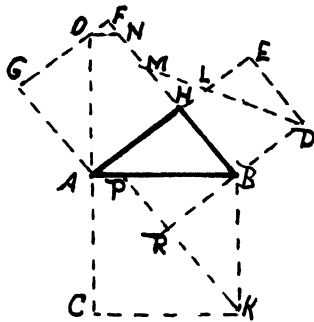


Fig. 130

In fig. 130, extend CA to O, and draw ON and KP par. to AB and BH respectively, and extend DB to R. Take BM = AB and draw DM. Then we have sq. AK = (trap. ACKP = trap. OAHN) + (tri. BRK = trap. BDLH + tri. MHL = tri. OPN) + (tri. PRB = tri. LED). \therefore sq. upon AB = sq. upon BH + sq. upon AH. $\therefore h^2 = a^2 + b^2$.

a. See Math. Mo., V. IV, 1897, p. 170, proof XLIV.

Thirty

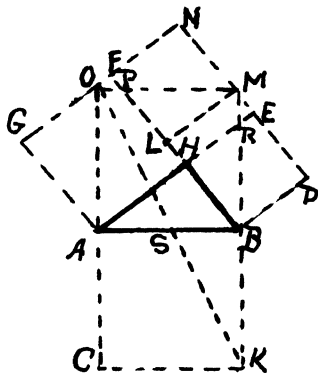


Fig. 131

Fig. 131 objectifies the lines to be drawn and how they are drawn is readily seen.

Since tri. OMN = tri. ABH, tri. MPL = tri. BRH, tri. BML = tri. AOG, and tri. OSA = tri. KBS (K is the pt. of intersection of the lines MB and OS) then sq. AK = trap. ACKS + tri. KSB = tri. KOM = trap. BMOS + tri. OSA = quad. AHPO + tri. ABH

+ tri. BML + tri. MPL = quad. AHPO + tri. OMN + tri. AOG + tri. BRH = (pentagon AHPOG + tri. OPF) + (trap. PMNF = trap. RBDE) + tri. BRH = sq. HG + sq. HD. \therefore sq. upon AB = sq. upon HD + sq. upon AH. $\therefore h^2 = a^2 + b^2$.

a. See Sci. Am. Sup., V. 70, p. 383, Dec. 10, 1910. It is No. 14 of A. R. Colburn's 108 proofs.

Thirty-One

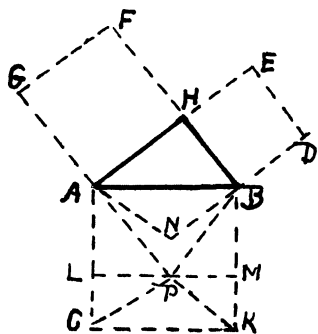


Fig. 132

Extend GA making AP = AG; extend DB making BN = BD = CP. Tri. CKP = tri. ANB = $\frac{1}{2}$ sq. HD = $\frac{1}{2}$ rect. LK. Tri. APB = $\frac{1}{2}$ sq. HG = $\frac{1}{2}$ rect. AM. Sq. AK = rect. AM + rect. LK.

\therefore sq. upon AB = sq. upon HB + sq. upon AH. $\therefore h^2 = a^2 + b^2$. Q.E.D.

a. This is Huygens' proof (1657); see also Ver-sluis, p. 25, fig. 22.

Thirty-Two

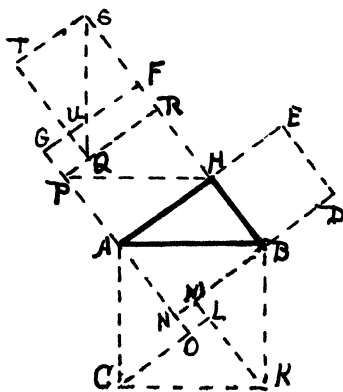
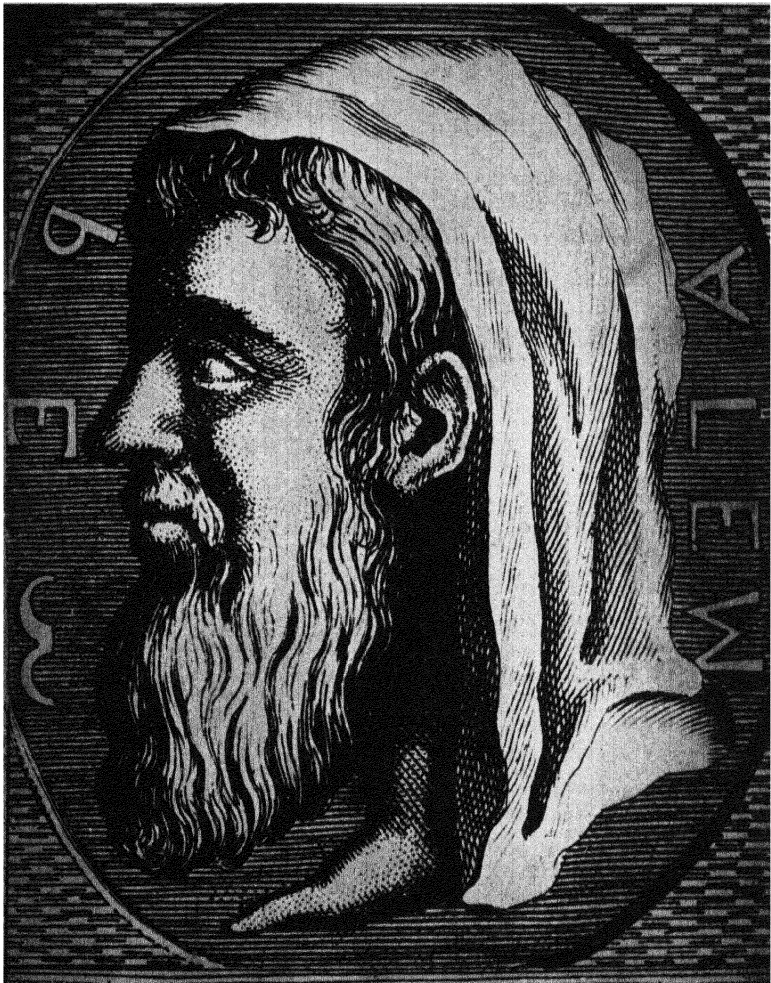


Fig. 133

Extend GA making AD = AO. Extend DB to N, draw CL and KM. Extend BF to S making FS = HB, complete sq. SU, draw HP par. to AB, PR par. to AH and draw SQ.

Then, obvious, sq. AK = 4 tri. BAN + sq. NL = rect. AR + rect. TR + sq. GQ = rect. AR + rect. QF + sq. GQ + (sq. TF = sq. ND) = sq. HG + sq. HD. \therefore sq. upon AB = sq. upon BH + sq. upon AH. $\therefore h^2 = a^2 + b^2$. Q.E.D.



EUCLID

Lived about 300 B.C.

a. This proof is credited to Miss E. A. Coolidge, a blind girl. See *Journal of Education*, V. XXVIII, 1888, p. 17, 26th proof.

b. The reader will note that this proof employs exactly the same dissection and arrangement as found in the solution by the Hindu mathematician, Bhaskara. See fig. 324, proof Two Hundred Twenty-Five.

(b) THOSE PROOFS IN WHICH PAIRS OF THE DISSECTED PARTS ARE SHOWN TO BE EQUIVALENT.

As the triangle is fundamental in the determination of the equivalency of two areas, Euclid's proof will be given first place.

Thirty-Three

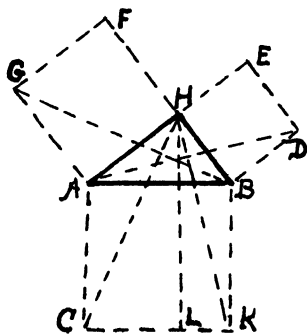


Fig. 134

Draw HL perp. to CK,
and draw HC, HK, AD and BG.
Sq. AK = rect. AL + rect. BL
= 2 tri. HAC + 2 tri. HBC
= 2 tri. GAB + 2 tri. DBA
= sq. GH + sq. HD. \therefore sq. upon
AB = sq. upon BH + sq. upon AH
a. Euclid, about 300

B.C. discovered the above proof, and it has found a place in every standard text on geometry. Logically no better proof can be devised than Euclid's.

For the old descriptive form of this proof see *Elements of Euclid* by Todhunter, 1887, Prop. 47, Book I. For a modern model proof, second to none, see Beman and Smith's *New Plane and Solid Geometry*, 1899, p. 102, Prop. VIII, Book II. Also see Heath's *Math. Monographs*, No. 1, 1900, p. 18, proof I; Versluys, p. 10, fig. 3, and p. 76, proof 66 (algebraic); Fourrey, p. 70, fig. a;

also The New South Wales Freemason, Vol. XXXIII, No. 4, April 1, 1938, p. 178, for a fine proof of Wor. Bro. W. England, F.S.P., of Auckland, New Zealand. Also Dr. Leitzmann's work (1930), p. 29, fig's 29 and 30.

b. I have noticed lately two or three American texts on geometry in which the above proof does not appear. I suppose the author wishes to show his originality or independence--possibly up-to-dateness. He shows something else. The leaving out of Euclid's proof is like the play of Hamlet with Hamlet left out.

c. About 870 there worked for a time, in Bagdad, Arabia, the celebrated physician, philosopher and mathematician *Ṭābit ibn Qurra ibn Mervān* (826-901), *Abū-Ḥasan, al-Ḥarrānī*, a native of Ḥarrān in Mesopotamia. He revised *Ishāq ibn Ḥoneiu*'s translation of Euclid's Elements, as stated at foot of the photostat.

See David Eugene Smith's "History of Mathematics," (1923), Vol. I, pp. 171-3.

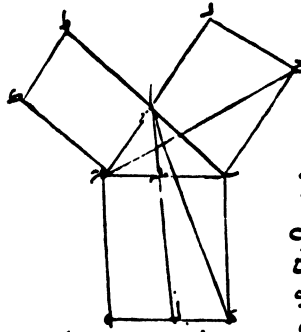
d. The figure of Euclid's proof, Fig. 134 above, is known by the French as pon asinorum, by the Arabs as the "Figure of the Bride."

e. "The mathematical science of modern Europe dates from the thirteenth century, and received its first stimulus from the Moorish Schools in Spain and Africa, where the Arab works of Euclid, Archimedes, Apollonius and Ptolemy were not uncommon...."

"First, for the geometry. As early as 1120 an English monk, named Adelhard (of Bath), had obtained a copy of a Moorish edition of the Elements of Euclid; and another specimen was secured by Gerard of Cremona in 1186. The first of these was translated by Adelhard, and a copy of this fell into the hands of Giovanni Campano or Companus, who in 1260 reproduced it as his own. The first printed edition was taken from it and was issued by Ratdolt at Venice in 1482." A History of Mathematics at Cambridge, by W. W. R. Ball, edition 1889, pp. 3 and 4.

مسلم كوكب

بعض الناس يفترون على
المسلمين في دعوتهم



مسلمك
بأسرع لغتها
وغير ذلك
تبرهن أن مسطح
بأسرع
حزق فاذا مربع
لمس وأس مربع
من أجاز ودلك

ما اردنا ان نذكر وجهدنا ان كل من يريد ان يعرف ان
يجعل ومنه المرات ان المثلث تقسم بمخارج اختلف
المثلث ونجد ذلك في كتابه اذ يذكر ان كل من
مرس انما يسهل في الاثبات كما يشاء وتفضل اليك
من ان قد فتت نكتة الزاوية والى ربا لا يحسح خط المس
المواسب ورا بالابلت مرنة القندين عليها اولا يعم بال
اصلا باب سهل مربع مجموعها وتقبل احدها واما اشبه لا
ان كذا في وان كان نحو قويا الى نظرك كما قول اذا اردنا
ان يكون مربع احد ضلعي النما مربع الجهة الاخرى من المثلث
ايه نكرن مطلقا على المثلث ولكن المثلث ومرح وتر القاب
وخط الالموازيه لها ولا مطلق مربع انت ومرة
فيا اما انك ورس ج ا او يكون الطول منه او انظر القبع
تربحها اما مطلقا على ا او خارجة عن ا او على
ورفع الى ا ف فدان را وبس اب ج ه س تا ف يمان ورا و
م ربع مشترك فبقية را وبس ا ج ح س تا هتا ويتين فتم
ن منسوب ا ج ح س تا مطلق اب ف ورا ورا الف مانه
لغرضه ج تا ورا ورا ج س تا على انما تر كبرت وادبه

PYTHAGOREAN THEOREM IN ṬĀBIT IBN QORRA'S TRANSLATION OF EUCLID

The translation was made by Ishâq ibn Ḥonein (died 910) but was revised by Ṭābit ibn Qorra, c. 890. This manuscript was written in 1350.

Thirty-Four

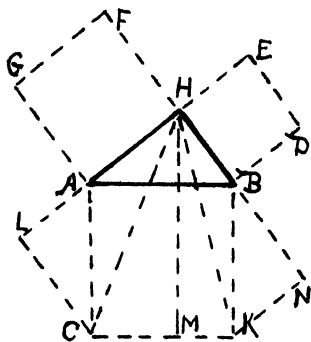


Fig. 135

Extend HA to L making
 $AL = HE$, and HB to N making
 $BN = HF$, draw the perp. HM,
 and join LC, HC, and KN. Ob-
 viously tri's ABH, CAL and
 BKN are equal. \therefore sq. upon AK
 $=$ rect. AM + rect. BM = 2 tri.
 HAC + 2 tri. HBK = $HA \times CL$
 $+ HB \times KN =$ sq. HG + sq. HD.
 \therefore sq. upon AB = sq. upon HB
 $+ \text{sq. upon HA. } \therefore h^2 = a^2 + b^2.$

a. See Edwards' Geom.,
 p. 155, fig. (4); Versluys,
 p. 16, fig. 12, credited to
 De Gelder (1806).

b. "To illumine and enlarge the field of consciousness, and to extend the growing self, is one reason why we study geometry."

"One of the chief services which mathematics has rendered the human race in the past century is to put 'common sense' where it belongs, on the top-most shelf next to the dusty canister labeled 'discarded nonsense.'" Bertrand Russell.

c. "Pythagoras and his followers found the ultimate explanation of things in their mathematical relations."

Of Pythagoras, as of Omar Khayyam:

"Myself when young did eagerly frequent
 Doctor and Saint, and heard great argument
 About it and about; but evermore
 Came out by the same door where in I went."

HISTORY SAYS:

1. "Pythagoras, level-headed, wise man, went quite mad over seven. He found seven sages, seven wonders of the world, seven gates to Thebes, seven heroes against Thebes, seven sleepers of Ephesus, seven dwarfs beyond the mountains--and so on up to seventy times seven."
2. "Pythagoras was inspired--a saint, prophet, founder of a fanatically religious society."
3. "Pythagoras visited Ionia, Phoenicia and Egypt, studied in Babylon, taught in Greece, committed nothing to writing and founded a philosophical society."
4. "Pythagoras declared the earth to be a sphere, and had a movement in space."
5. "Pythagoras was one of the nine saviors of civilization."
6. "Pythagoras was one of the four protagonists of modern science."
7. "After Pythagoras, because of the false dicta of Plato and Aristotle, it took twenty centuries to prove that this earth is neither fixed nor the center of the universe."
8. "Pythagoras was something of a naturalist--he was 2500 years ahead of the thoughts of Darwin."
9. "Pythagoras was a believer in the Evolution of man."
10. "The teaching of Pythagoras opposed the teaching of Ptolemy."
11. "The solar system as we know it today is the one Pythagoras knew 2500 years ago."
12. "What touched Copernicus off? Pythagoras who taught that the earth moved around the sun, a great central ball of fire."
13. "The cosmology of Pythagoras contradicts that of the Book of Genesis--a barrier to free thought and scientific progress."
14. "Pythagoras saw man--not a cabbage, but an animal--a bundle of possibilities--a rational animal."
15. "The teaching of Pythagoras rests upon the Social, Ethical and Aesthetical Laws of Nature."

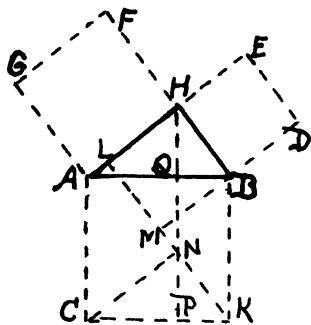
Thirty-Five

Fig. 136

Draw HN par. to AC ,
 KL par. to BF , CN par. to AH ,
 and extend DB to M . It is
 evident that sq. $AK =$ hexa-
 gon $ACNKBH =$ par. $ACNH +$ par.
 $HNKB = AH \times LN + BH \times HL$
 $=$ sq. $HG +$ sq. HD .

\therefore sq. upon $AB =$ sq.
 upon $BH +$ sq. upon AH .

a. See Edwards' *Geom.*,
 1895, p. 161, fig. (32); Ver-
 sluys, p. 23, fig. 21, cred-
 ited to Van Vieth (1805);
 also, as an original proof,

by Joseph Zelson a sophomore in West Phila., Pa.,
 High School, 1937.

b. In each of the 39 figures given by Edwards
 the author hereof devised the proofs as found herein.

Thirty-Six

In fig. 136, produce HN to P . Then sq. AK
 $=$ (rect. $BP =$ paral. $BHNC =$ sq. HD) + (rect. AP
 $=$ paral. $HACN =$ sq. HG).

\therefore sq. upon $AB =$ sq. upon $BH +$ sq. upon AH .
 $\therefore h^2 = a^2 + b^2$.

a. See *Math. Mo.* (1859), Vol. 2, Dem. 17,
 fig. 1.

Thirty-Seven

In fig. 137, the construction is evident.
 Sq. $AK =$ rect. $BL +$ rect. $AL =$ paral. $BM +$ paral. AM
 $=$ paral. $BN +$ paral. $AO =$ sq. $BE +$ sq. AF .

\therefore sq. upon $AB =$ sq. upon $BH +$ sq. upon AH .

a. See Edwards' *Geom.*, 1895, p. 160, fig.
 (28); Ebene Geometrie von G. Mahler, Leipzig, 1897,

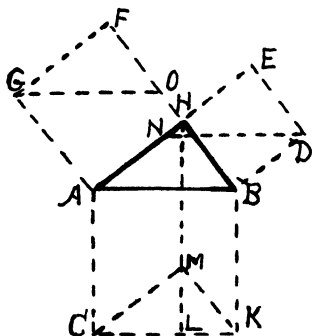


Fig. 137

p. 80, fig. 60; and Math. Mo., V. IV, 1897, p. 168, proof XXXIV; Versluys, p. 57, fig. 60, where it is credited to Hauff's work, 1803.

Thirty-Eight

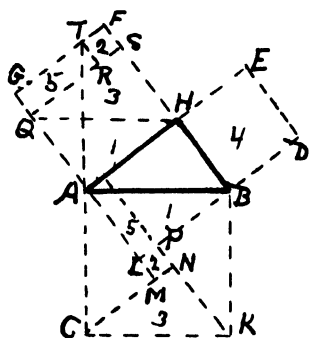


Fig. 138

In fig. 138, the construction is evident, as well as the parts containing like numerals.

Sq. AK = tri. BAL
 + tri. CKN + sq. LN + (tri. ACM
 + tri. KBP) + tri. HQA + tri.
 QHS + sq. RF + (rect. HL = sq.
 HP + rect. AP = sq. HD + rect.
 GR) = sq. HD + sq. HG.

∴ sq. upon AB = sq.
 upon BH + sq. upon AH.

a. See Heath's Math. Monographs, No. 2, p. 33, proof XXI.

Thirty-Nine

Produce CA to P, draw PHN, join NE, draw HO perp. to CR, CM par. to AH, join MK and MA and produce DB to L. From this dissection there results:
 Sq. AK = rect. AO + rect. BO = (2 tri. MAC = 2 tri. ACM = 2 tri. HAM = 2 tri. AHP = sq. HG) + (rect. BHMK = 2 tri. NHL = 2 tri. HLN = 2 tri. NEH = sq. HD).

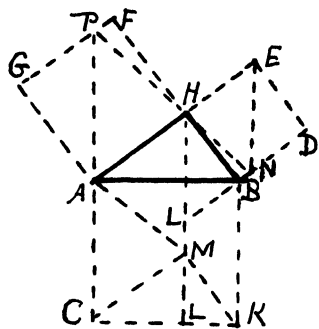


Fig. 139

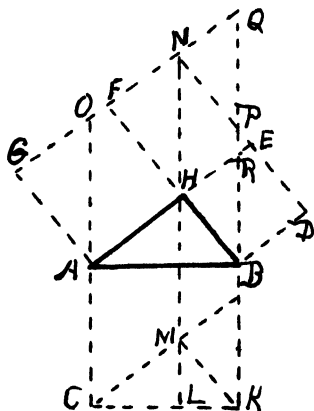


Fig. 140

\therefore sq. upon AB = sq. upon HB + sq. upon HA. $\therefore h^2 = a^2 + b^2$. Q.E.D.

a. Devised by the author Nov. 16, 1933.

Forty

Fig. 140 suggests its construction, as all lines drawn are either perp. or par. to a side of the given tri. ABH. Then we have sq. AK = rect. BL + rect. AL = paral. BHMK + paral. AHMC = paral. BHNP + paral. AHNO = sq. HD + sq. HG. \therefore sq. upon AB = sq. upon BH + sq. upon AH.

a. This is known as Haynes' proof; see Math. Magazine, Vol. I, 1882, p. 25, and School Visitor, V. IX, 1888, p. 5, proof IV; also see Fourrey, p. 72, fig. a, in Edition arabe des Elements d'Euclides.

Forty-One

Draw BQ perp. to AB meeting GF extended, HN par. to BQ, NP par. to HF, thus forming OARQ; draw OL par. to AB, CM par. to AH, AS and KT perp. to CM, and SU par. to AB, thus dissecting sq. AK into parts 1, 2, 3, 4 and 5.

Sq. AK = paral. AEQO, for sq. AK = [(quad. ASMB = quad. AHLO) + (tri. CSA = tri. NFH = tri. OGH) + (tri. SUT = tri. OLF)] = sq. HG] + [(trap. CKUS

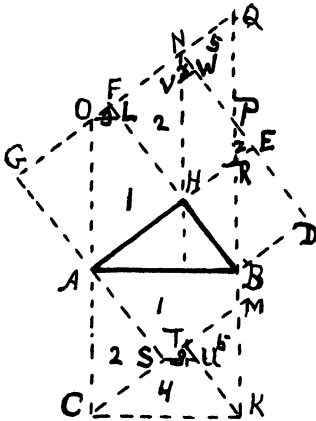


Fig. 141

= trap. NHRP = tri. NVW
 + trap. EWHV, since tri. EPR
 = tri. WNV = trap. BDER)
 + (tri. NPQ = tri. HBR) = sq.
 HD] = sq. HG + sq. HD.
 \therefore sq. upon AB = sq.
 upon BH + sq. upon HA. $\therefore h^2$
 = $a^2 + b^2$.

a. This proof and fig. was formulated by the author Dec. 12, 1933, to show that, having given a paral. and a sq. of equal areas, and dimensions of paral. = those of the sq., the paral. can be dissected into parts, each equivalent to a like part in the square.

Forty-two

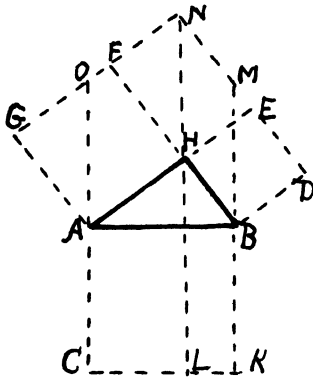


Fig. 142

The construction of fig. 142 is easily seen.
 Sq. AK = rect. BL + rect. AL
 = paral. HBMN + paral. AHNO
 = sq. HD + sq. HG. \therefore sq.
 upon AB = sq. upon BH + sq.
 upon AH. $\therefore h^2 = a^2 + b^2$.

a. This is Lecchio's proof, 1753. Also see Math. Mag., 1859, Vol. 2, No. 2, Dem. 3, and credited to Charles Young, Hudson, O., (afterwards Prof. Astronomy, Princeton College, N.J.); Jury Wipper, 1880, p. 26, fig. 22 (Historical Note);

Olney's Geom., 1872, Part III, p. 251, 5th method; Jour. of Education, V. XXV, 1887, p. 404, fig. III; Hopkins' Plane Geom., 1891, p. 91, fig. II; Edwards'

Geom., 1895, p. 159, fig. (25); Am. Math. Mo., V. IV, 1897, p. 169, XL; Heath's Math. Monographs, No. 1, 1900, p. 22, proof VI; Versluys, 1914, p. 18, fig. 14.

b. One reference says: "This proof is but a particular case of Pappus' Theorem."

c. Pappus was a Greek Mathematician of Alexandria, Egypt, supposed to have lived between 300 and 400 A.D.

d. Theorem of Pappus: "If upon any two sides of any triangle, parallelograms are constructed, (see fig. 143), their sum equals the possible resulting parallelogram determined upon the third side of the triangle."

e. See Chauvenet's Elem'y Geom. (1890), p. 147, Theorem 17. Also see F. C. Boon's proof, 8a, p. 106.

f. Therefore the so-called Pythagorean Proposition is only a particular case of the theorem of Pappus; see fig. 144 herein.

Theorem of Pappus

Let ABH be any triangle; upon BH and AH construct any two dissimilar parallelograms BE and HG ; produce GF and DE to C , their point of intersection; join C and H and produce CH to L making $KL = CH$; through A and B draw MA to N making $AN = CH$, and OB to P making $BP = CH$.

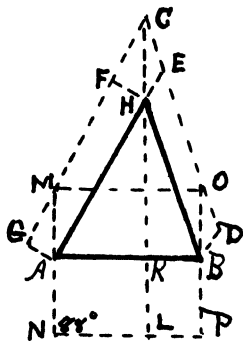


Fig. 143

Since tri. $GAM =$ tri. FHC , being equiangular and side $GA = FH$. $\therefore MA = CH = AN$; also $BO = CH = BP = KL$. Paral. $EHBD +$ paral. $HFGA =$ paral. $CHBO +$ paral. $HCMA =$ paral. $KLBP +$ paral. $ANLK =$ paral. AP .

Also paral. $HD +$ paral. $HG =$ paral. MB , as paral. $MB =$ paral. AP .

a. As paral. HD and paral. HG are not similar, it follows that $BH^2 + HA^2 \neq AB^2$.

b. See Math. Mo. (1858), Vol. I, p. 358, Dem. 8, and Vol. II, pp. 45-52, in which this theorem is given by Prof. Charles A. Young, Hudson, O., now Astronomer, Princeton, N.J. Also David E. Smith's Hist. of Math., Vol. I, pp. 136-7.

c. Also see Masonic Grand Lodge Bulletin, of Iowa, Vol. 30 (1929), No. 2, p. 44, fig.; also Fourrey, p. 101, Pappus, Collection, IV, 4th century, A.D.; also see p. 105, proof 8, in "A Companion to Elementary School Mathematics," (1924), by F. C. Boon, A.B.; also Dr. Leitzmann, p. 31, fig. 32, 4th Edition; also Heath, History, II, 355.

d. See "Companion to Elementary School Mathematics," by F. C. Boon, A.B. (1924), p. 14; Pappus lived at Alexandria about A.D. 300, though date is uncertain.

e. This Theorem of Pappus is a generalization of the Pythagorean Theorem. Therefore the Pythagorean Theorem is only a corollary of the Theorem of Pappus.

Forty-Three

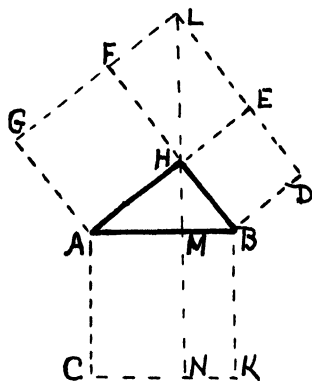


Fig. 144

By theorem of Pappus, $MN = LH$. Since angle BHA is a rt. angle, HD and HG are rectangular, and assumed squares (Euclid, Book I, Prop. 47). But by Theorem of Pappus, paral. HD + paral. HG = paral. AK.

\therefore sq. upon AB = sq. upon BH + sq. upon HG. $\therefore h^2 = a^2 + b^2$.

a. By the author,
Oct. 26, 1933.

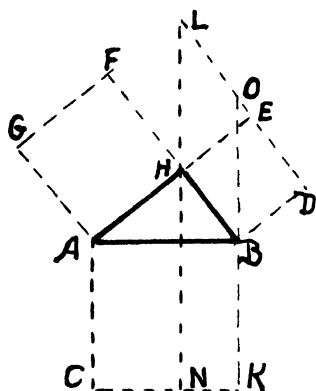
Forty-Four

Fig. 145

Produce DE to L making $EL = HF$, produce KB to O, and draw LN perp. to CK. Sq. $AK = \text{rect. } MK + \text{rect. } MC = [\text{rect. } BL \text{ (as } LH = MN)] = \text{sq. } HD] + (\text{similarly, sq. } HG)$.

$\therefore \text{sq. upon } AB = \text{sq. upon } HB + \text{sq. upon } HG. \therefore h^2 = a^2 + b^2.$

a. See Versluys, p. 19, fig. 15, where credited to Nasir-Ed-Din (1201-1274); also Fourrey, p. 72, fig. 9.

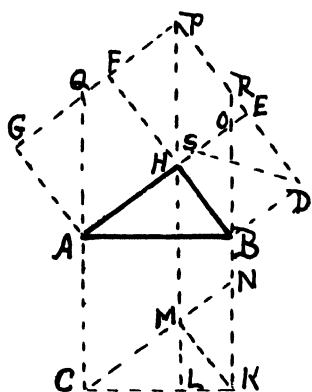
Forty-Five

Fig. 146

In fig. 146 extend DE and GF to P, CA and KB to Q and R respectively, draw CN par. to AH and draw PL and KM perp. to AB and CN respectively. Take $ES = HO$ and draw DS.

Sq. $AK = \text{tri. } KNM + \text{hexagon } ACKMNB = \text{tri. } BOH + \text{pentagon } ACNBH = \text{tri. } DSE + \text{pentagon } QAORP = \text{tri. } DES + \text{paral. } AHPQ + \text{quad. } PHOR = \text{sq. } HG + \text{tri. } DES + \text{paral. } BP - \text{tri. } BOH = \text{sq. } HG + \text{tri. } DES + \text{trap. } HBDS = \text{sq. } HG + \text{sq. } HD.$

$\therefore \text{sq. upon } AB = \text{sq. upon } BH + \text{sq. upon } AH.$

a. See Am. Math. Mo., V. IV, 1897, p. 170, proof XLV.

Forty-Six

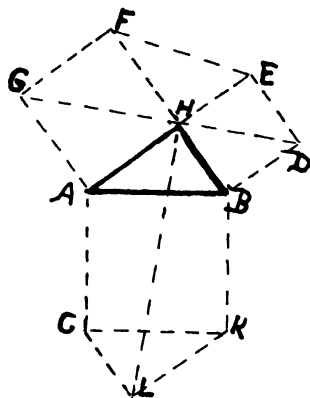


Fig. 147

The construction needs no explanation; from it we get sq. AK + 2 tri. ABH = hexagon ACLKBH = 2 quad. ACLH = 2 quad. FEDG = hexagon ABDEFG = sq. HD + sq. HA + 2 tri. ABH.

$$\therefore \text{sq. upon AB} = \text{sq. upon BH} + \text{sq. upon AH.} \therefore h^2 = a^2 + b^2.$$

a. According to F. C. Boon, A.B. (1924), p. 107 of his "Miscellaneous Mathematics," this proof is that of Leonardo da Vinci (1452-1519).

b. See Jury Wipper, 1880, p. 32, fig. 29, as

found in "Aufangsgrunden der Geometrie" von Tempelhoff, 1769; Versluys, p. 56, fig. 59, where Tempelhoff, 1769, is mentioned; Fourrey, p. 74. Also proof 9, p. 107, in "A Companion to Elementary School Mathematics," by F. C. Boon, A.B.; also Dr. Leitzmann, p. 18, fig. 22, 4th Edition.

Forty-Seven

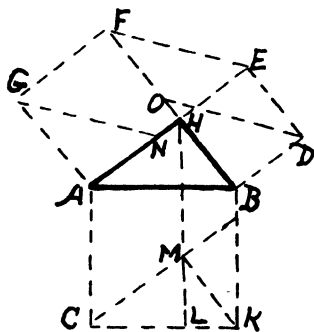


Fig. 148

In fig. 148 take BO = AH and AN = BH, and complete the figure; Sq. AK = rect. BL + rect. AL = paral. HMKB + paral. ACMH = paral. FODE + paral. GNEF = sq. DH + sq. GH.

$$\therefore \text{sq. upon AB} = \text{sq. upon BH} + \text{sq. upon AH.} \therefore h^2 = a^2 + b^2.$$

a. See Edwards' Geom., 1895, p. 158, fig. (21), and

Am. Math. Mo., V. IV, 1897, p. 169 proof XLI.

Forty-Eight

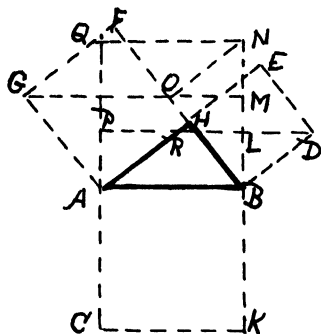


Fig. 149

In fig. 149 extend CA to Q and complete sq. QB. Draw GM and DP each par. to AB, and draw NO perp. to BF. This construction gives sq. $AB = \text{sq. AN} = \text{rect. AL} + \text{rect. PN} = \text{paral. BDRA} + (\text{rect. AM} = \text{paral. GABO}) = \text{sq. HD} + \text{sq. HG}$.

$\therefore \text{sq. upon AB} = \text{sq. upon BH} + \text{sq. upon AH} \therefore h^2 = a^2 + b^2$.

a. See Edwards' Geom., 1895, p. 158, fig. (29), and Am. Math. Mo., V. IV, 1897, p. 168, proof XXXV.

Forty-Nine

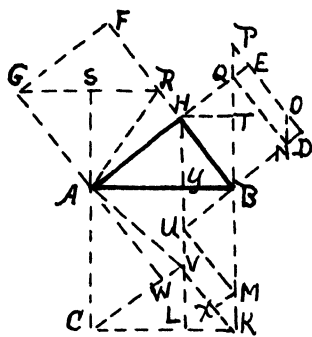


Fig. 150

In fig. 150 extend KB to meet DE produced at P, draw QN par. to DE, NO par. to BP, GR and HT par. to AB, extend CA to S, draw HL par. to AC, CV par. to AH, KV and MU par. to BH, MX par. to AH, extend GA to W, DB to U, and draw AR and AV. Then we will have $\text{sq. AK} = \text{tri. ACW} + \text{tri. CVL} + \text{quad. AWVY} + \text{tri. VKL} + \text{tri. KMX} + \text{trap. UVXM} + \text{tri. MBU} + \text{tri. BUY} = (\text{tri. GRF} + \text{tri. AGS} + \text{quad. AHRS}) + (\text{tri. BHT} + \text{tri. OND} + \text{trap. NOEQ} + \text{tri. QDN} + \text{tri. HQT}) = \text{sq. BE} + \text{sq. AF}$.

\therefore sq. upon AB = sq. upon BH + sq. upon AH.
 $\therefore h^2 = a^2 + b^2$.

a. This is E. von Littrow's proof, 1839; see also Am. Math. Mo., V. IV, 1897, p. 169, proof XXXVII.

Fifty

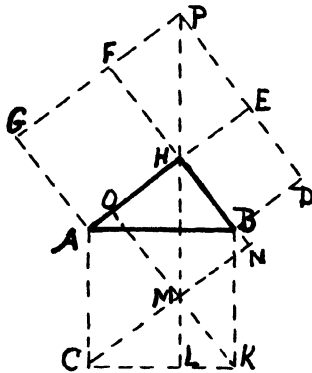


Fig. 151

Extend GF and DE to P, draw PL perp. to CK, CN par. to AH meeting HB extended, and KO perp. to AH. Then there results: sq. AK [(trap. ACNH - tri. MNH = paral. ACMH = rect. AL) = (trap. AHPG - tri. HPF = sq. AG)] + [(trap. HOKB - tri. OMH = paral. HMKB = rect. BL) = (trap. HBDP - tri. HEP = sq. HD)].

\therefore sq. upon AB = sq. upon BH + sq. upon AH. $\therefore h^2 = a^2 + b^2$.

a. See Am. Math. Mo., V. IV, 1897, p. 169, proof XLII.

Fifty-One

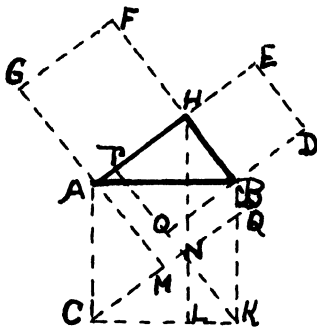


Fig. 152

Extend GA to M making AM = AH, complete sq. HM, draw HL perp. to CK, draw CM par. to AH, and KN par. to BH; this construction gives: sq. AK = rect. BL + rect. AL = paral. HK + paral. HACN = sq. BP + sq. HM = sq. HD + sq. HG.

\therefore sq. upon AB = sq. upon BH + sq. upon AH. $\therefore h^2 = a^2 + b^2$.

a. Vieth's proof--see Jury Wipper, 1880, p. 24, fig. 19, as given by Vieth, in "Aufangsgrunden der Mathematik," 1805; also Am. Math. Mo., V. IV, 1897, p. 169, proof XXXVI.

Fifty-Two

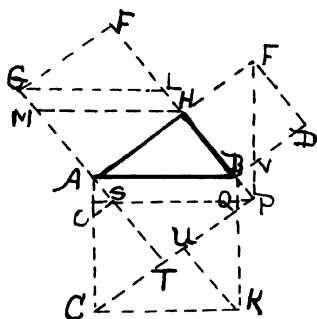


Fig. 153

= $a^2 + b^2$. Q.E.D.

a. After three days of analyzing and classifying solutions based on the A type of figure, the above dissection occurred to me, July 16, 1890, from which I devised above proof.

Fifty-Three

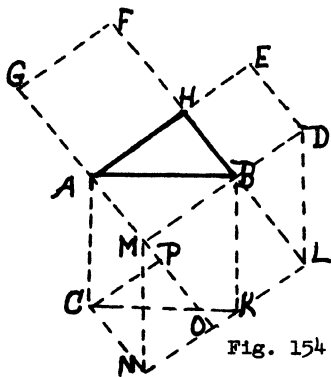


Fig. 154

In fig. 153 construct the sq. HT, draw GL, HM, and PN par. to AB; also KU par. to BH, OS par. to AB, and join EP. By analysis we find that sq. AK = (trap. CTSO + tri. KRU) + [tri. CKU + quad. STRQ + (tri. SON + tri. PRQ) + rect. AQ] = (trap. EHBV + tri. EVD) + [tri. GLF + tri. HMA + (paral. SB = paral. ML)] = sq. HD + sq. AF.

\therefore sq. upon AB = sq. upon BH + sq. upon AH. $\therefore h^2$

In fig. 154 through K draw NL par. to AH, extend HB to L, GA to O, DB to M, draw DL and MN par. to BK, and CN par. to AO.

Sq. AK = hexagon ACNKBM = paral. CM + paral. KM = sq. CO + sq. ML = sq. HD + sq. HG.

\therefore sq. upon AB = sq. upon BH + sq. upon AH.

(16). a. See Edwards' *Geom.*, 1895, p. 157, fig.

Fifty-Four

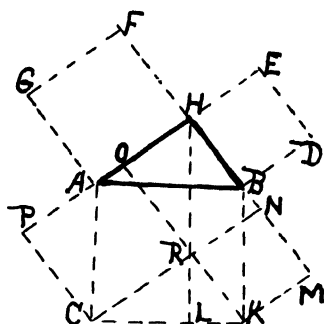


Fig. 155

In fig. 155 extend HB to M making $BM = AH$, HA to P making $AP = BH$, draw CN and KM each par. to AH, CP and KO each perp. to AH, and draw HL perp. to AB. Sq. AK = rect. BL + rect. AL = paral. RKBH + paral. CRHA = sq. RM + sq. CO = sq. HD + sq. HG. \therefore sq. upon AB = sq. upon BH + sq. upon AH. $\therefore h^2 = a^2 + b^2$.

a. See *Am. Math. Mo.*, V. IV, 1897, p. 169, proof XLIII.

Fifty-Five

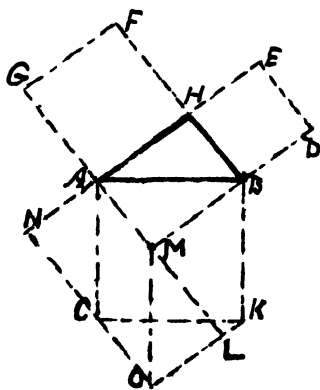


Fig. 156

Extend HA to N making $AN = HB$, DB and GA to M, draw, through C, NO making $CO = BH$, and join MO and KO.

Sq. AK = hexagon ACOKBM = para. COMA + paral. OKBM = sq. HD + sq. HG. \therefore sq. upon AB = sq. upon BH + sq. upon AH. $\therefore h^2 = a^2 + b^2$.

a. This proof is credited to C. French, Winchester, N.H. See *Journal of Education*, V. XXVIII, 1888, p. 17, 23d proof; Edwards' *Geom.*, 1895, p. 159, fig. (26); Heath's *Math. Monographs*, No. 2, p. 31, proof XVIII.

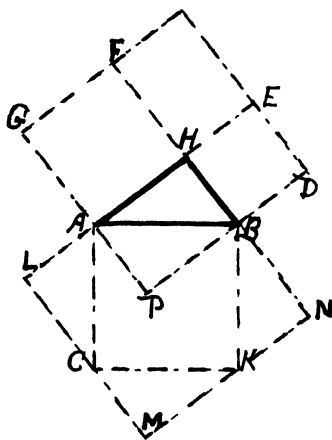
Fifty-Six

Fig. 157

Complete the sq's OP
and HM, which are equal.

Sq. AK = sq. LN - 4
tri. ABH = sq. OP - 4 tri.
ABH = sq. HD + sq. HG. \therefore sq.
upon AB = sq. upon BH + sq.
upon HA. $\therefore h^2 = a^2 + b^2$.
Q.E.D.

a. See Versluys, p.
54, fig. 56, taken from Del-
boeuf's work, 1860; Math. Mo.,
1859, Vol. II, No. 2, Dem. 18,
fig. 8; Fourrey, Curios.
Geom., p. 82, fig. e, 1683.

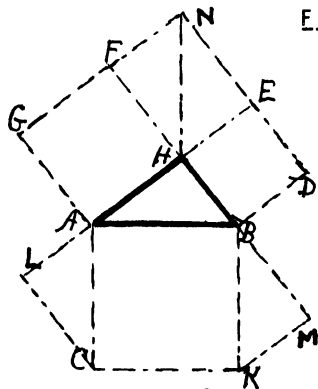
Fifty-Seven

Fig. 158

Complete rect. FE and
construct the tri's ALC and
KMB, each = tri. ABH.

It is obvious that
sq. AK = pentagon CKMHL - 3
tri. ABH = pentagon ABDNG
- 3 tri. ABH = sq. HD + sq.
HG. \therefore sq. upon AB = sq. upon
HD + sq. upon HA. $\therefore h^2 = a^2$
+ b^2 .

a. See Versluys, p. 55,
fig. 57.

Fifty-Eight

In fig. 159 complete the squares AK, HD and
HG, also the paral's FE, GC, AO, PK and BL. From

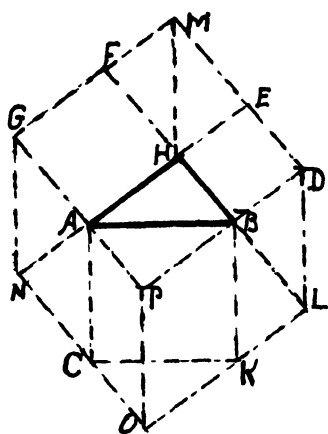


Fig. 159

these we find that sq. AK
 = hexagon ACOKBP = paral.
 OPGN - paral. CAGN + paral.
 POLD - paral. BKLD = paral.
 LDMH - (tri. MAE + tri. LDB)
 + paral. GNHM - (tri. GNA
 + tri. HMF) = sq. HD + sq. HG.
 \therefore sq. upon AB = sq. upon BH
 + sq. upon AH. $\therefore h^2 = a^2 + b^2$.

a. See Olney's Geom.,
 University Edition, 1872, p.
 251, 8th method; Edwards'
 Geom., 1895, p. 160, fig.
 (30); Math. Mo., Vol. II
 1859, No. 2, Dem. 16, fig. 8,
 and W. Rupert, 1900.

Fifty-Nine

In fig. 159, omit lines GN, LD, EM, MF and
 MH, then the dissection comes to: sq. AK = hexagon
 ANULBP - 2 tri. ANO = paral. PC + paral. PK = sq. HD
 + sq. HG. \therefore sq. upon AB = sq. upon HD + sq. upon HA.
 $\therefore h^2 = a^2 + b^2$. Q.E.D.

a. See Versluys, p. 66, fig. 70.

Sixty

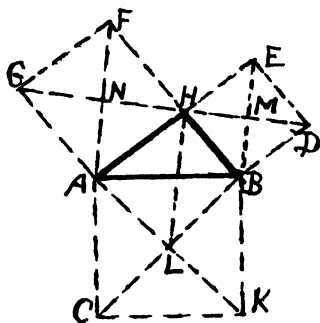


Fig. 160

In the figure draw
 the diag's of the sq's and
 draw HL. By the arguments
 established by the dissec-
 tion, we have quad. ALBH
 = quad. ABMN (see proof, fig.
 334).

Sq. AK = 2 (quad. AKBH
 - tri. ABH) = 2 (quad. ABDG
 - tri. ABH) = $\frac{1}{2}$ sq. EB + $\frac{1}{2}$ sq.
 FA) = sq. HD + sq. HG. \therefore sq.
 upon AB = sq. upon HD + sq.
 upon HA. $\therefore h^2 = a^2 + b^2$.

a. See E. Fourrey's *Curios. Geom.*, p. 96,
fig. a.

Sixty-One

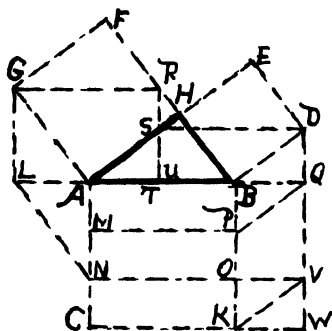


Fig. 161

GL and DW are each
perp. to AB, LN par. to HB,
QP and VK par. to BD, GR, DS,
MP, NO and KW par. to AB and
ST and RU perp. to AB. Tri.
DKV = tri. BPQ. $\therefore AN = MC$.

Sq. AK = rect. AP
+ rect. AO = (paral. ABDS
= sq. HD) + (rect. GU = paral.
GABR = sq. GH). \therefore sq. upon
AB = sq. upon HB + sq. upon
HA. $\therefore h^2 = a^2 + b^2$. Q.E.D.

a. See Versluys, p.
28, fig. 24--one of Werner's
coll'n, credited to Dobriner.

Sixty-Two

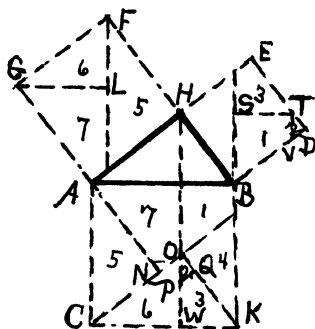


Fig. 162

Constructed and num-
bered as here depicted, it
follows that sq. AK = [(trap.
XORB = trap. SBTD) + (tri.
OPQ = tri. TVD) + (quad. PWKQ
= quad. USTE) = sq. HD]
+ [(tri. ACN = tri. FMH)
+ (tri. CWO = tri. GLF)
+ (quad. ANOX = quad. GAML)
= sq. HG].

\therefore sq. upon AB = sq.
upon BH + sq. upon HA. $\therefore h^2$
= $a^2 + b^2$. Q.E.D.

a. See Versluys, p.
33, fig. 32, as given by
Jacob de Gelder, 1806.

Sixty-Three

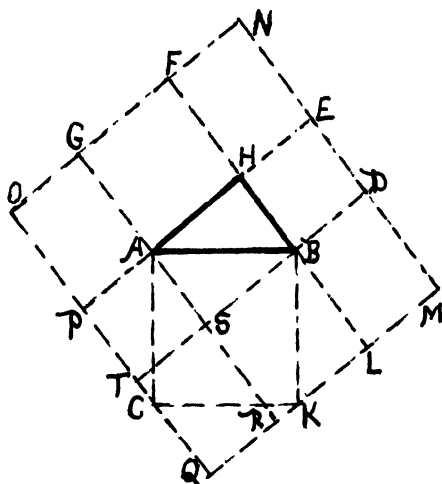


Fig. 163

Extend GF and DE to N, complete the square NQ, and extend HA to P, GA to R and HB to L.

From these dissected parts of the sq. NQ we see that sq. AK + (4 tri. ABH + rect. HM + rect. GE + rect. OA) = sq. NQ = (rect. PR = sq. HD + 2 tri. ABH) + (rect. AL = sq. HG + 2 tri. ABH) + rect. HM + rect. GE + rect. AO = sq. AK + (4 tri. ABH + rect. HM

+ rect. GE + rect. OA - 2 tri. ABH - 2 tri. ABH - rect. HM - rect. GE - rect. OA = sq. HD + sq. HG.

\therefore sq. AK = sq. HD + sq. HG.

\therefore sq. upon AB = sq. upon BH + sq. upon AH.

$\therefore h^2 = a^2 + b^2$.

a. Credited by Hoffmann, in "Der Pythagoräische Lehrsatz," 1821, to Henry Bood, of London, Eng. See Jury Wipper, 1880, p. 18, fig. 12; Ver-sluis, p. 53, fig. 55; also see Dr. Leitzmann, p. 20, fig. 23.

b. Fig. 163 employs 4 congruent triangles, 4 congruent rectangles, 2 congruent small squares, 2 congruent HG squares and sq. AK, if the line TB be inserted. Several variations of proof Sixty-Three may be produced from it, if difference is sought, especially if certain auxiliary lines are drawn.

Sixty-Four

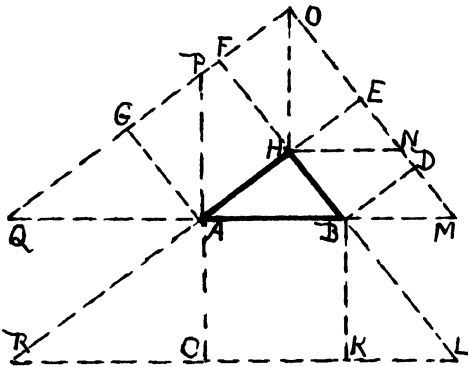


Fig. 164

= sq. HG) + (paral. HBMN = sq. HD).

\therefore sq. upon AB = sq. upon HB + sq. upon HA.

$\therefore h^2 = a^2 + b^2$.

a. See Jury Wipper, 1880, p. 30, fig. 28a; Versluys, p. 57, fig. 61; Fourrey, p. 82, Fig. c and d, by H. Bond, in *Geometry*, Londres, 1683 and 1733, also p. 89.

Sixty-Five

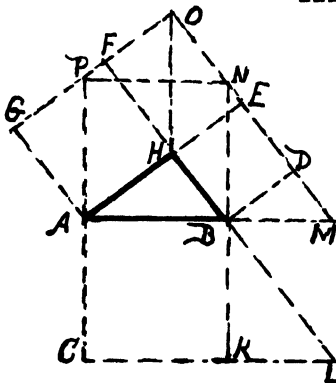


Fig. 165

In fig. 164, produce HB to L, HA to R meeting CK prolonged, DE and GF to O, CA to P, ED and FG to AB prolonged. Draw HN par. to, and OH perp. to AB. Obviously sq. AK = tri. RLH - (tri. RCA + tri. BKL + tri. ABH) = tri. QMO - (tri. QAP + tri. OHD + tri. ABH) = (paral. PANO

In fig. 165 extend HB and CK to L, AB and ED to M, DE and GF to O, CA and KB to P and N respectively and draw PN. Now observe that sq. AK = (trap. ACLB - tri. BLK) = [quad. AMNP = hexagon AHBNOP - (tri. NMB = tri. BLK) = paral. BO = sq. HD) + (paral. AO = sq. AF)].

\therefore sq. upon AB = sq. upon BH + sq. upon AH.

a. Devised by the author, July 7, 1901, but suggested by fig. 28b, in Jury Wipper, 1880, p. 31.

b. By omitting, from the fig., the sq. AK, and the tri's BLK and BMD, an algebraic proof through the mean proportional is easily obtained.

Sixty-Six

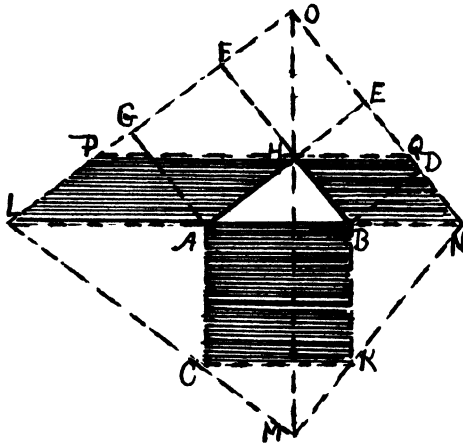


Fig. 166

In the construction make $CM = HA = PL$, $LC = FP$, $MK = DE = NQ$. $\therefore OL = LM$ and $MN = NO$. Then sq. $AK = \text{tri. } NLM - (\text{tri. } LCA + \text{tri. } CMK + \text{tri. } KNB) = \text{tri. } LNO - (\text{tri. } OPH + \text{tri. } HAB + \text{tri. } QOH) = \text{paral. } PLAG + \text{paral. } HBNQ = \text{sq. } HG + \text{sq. } HD$. $\therefore \text{sq. upon } AB = \text{sq. upon } BH + \text{sq. upon } HA$. $\therefore h^2 = a^2 + b^2$. Q.E.D.

a. See Versluys, p. 22, fig. 19, by J. D. Kruitbosch.

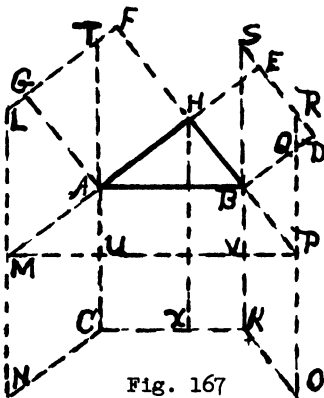


Fig. 167

Sixty-Seven

Make $AM = AH$, $BP = BH$, complete paral. MC and PK . Extend FG and NM to L , DE and KB to S , CA to T , OP to R , and draw MP .

Sq. $AK = \text{paral. } MC + \text{paral. } PK = \text{paral. } LA + \text{paral. } RB = \text{sq. } GH + \text{sq. } HD$.

\therefore sq. upon AB = sq. upon HB + sq. upon HA.
 $\therefore h^2 = a^2 + b^2$.

a. Math. Mo. (1859), Vol. II, No. 2, Dem. 19,
 fig. 9.

Sixty-Eight

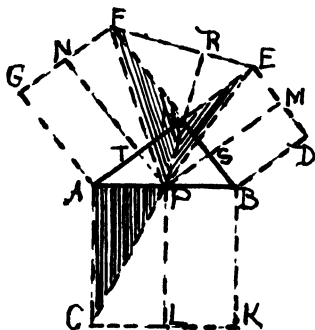


Fig. 168

as their altitudes: tri. (HPE = EHP = sq. HD + 4)
 : tri. (PHF = sq. HG + 4) = ER : FR. \therefore tri. HPE
 + tri. PHF : tri. PHF = (ER + FR = AC) : FR. $\therefore \frac{1}{4}$ sq.
 HD + $\frac{1}{4}$ sq. HG : tri. PHF = AC : FR. But (tri. PAC
 = $\frac{1}{4}$ sq. AK) : tri. PHF = AC : FR. $\therefore \frac{1}{4}$ sq. HD + $\frac{1}{4}$ sq.
 HG : $\frac{1}{4}$ sq. AK = tri. PHE : tri. PHF. $\therefore \frac{1}{4}$ sq. HD
 + $\frac{1}{4}$ sq. HG = $\frac{1}{4}$ sq. AK.

\therefore sq. upon AB = sq. upon HB + sq. upon HA.
 $\therefore h^2 = a^2 + b^2$. Q.E.D.

a. Fig. 168 is unique in that it is the first
 ever devised in which all auxiliary lines and all
 triangles used originate at the middle point of the
 hypotenuse of the given triangle.

b. It was devised and proved by Miss Ann
 Condit, a girl, aged 16 years, of Central Junior-
 Senior High School, South Bend, Ind., Oct. 1938. This
 16-year-old girl has done what no great mathematician,
 Indian, Greek, or modern, is ever reported to have
 done. It should be known as the Ann Condit Proof.

Sixty-Nine

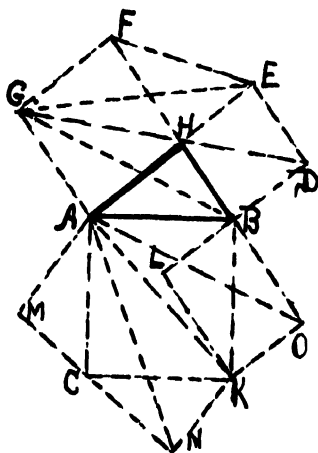


Fig. 169

Prolong HB to O making $BO = HA$; complete the rect. OL; on AC const. tri. $ACM = \text{tri. } ABH$; on CK const. tri. $CKN = \text{tri. } ABH$. Join AN, AK, AO, GB, GD, GE and FE.

It is obvious that $\text{tri. } ACN = \text{tri. } ABO = \text{tri. } ABG = \text{tri. } EFG$; and since $\text{tri. } DEG = [\frac{1}{2}(DE) \times (AE = AH + HE)] = \text{tri. } DBG = [\frac{1}{2}(DB = DE) \times (BF = AE)] = \text{tri. } AKO = [\frac{1}{2}(KO = DE) \times (HO = AE)] = \text{tri. } AKN = [\frac{1}{2}(KN = DE) \times (AN = AE)]$, then hexagon $ACNKO B - (\text{tri. } CNK + \text{tri. } BOK)$

$= (\text{tri. } ACN = \text{tri. } ABO = \text{tri. } ABG = \text{tri. } EFG) + (\text{tri. } AKN = \text{tri. } AKO = \text{tri. } GBD = \text{tri. } GED) - (\text{tri. } CNK + \text{tri. } BOK) = 2 \text{ tri. } ACN + 2 \text{ tri. } ABO - 2 \text{ tri. } CNK = 2 \text{ tri. } GAB + 2 \text{ tri. } ABD - 2 \text{ tri. } ABH = \text{sq. } AK = \text{sq. } HG + \text{sq. } HD.$

$\therefore \text{sq. upon } AB = \text{sq. upon } HB + \text{sq. upon } HA.$
 $\therefore h^2 = a^2 + b^2. \text{ Q.E.D.}$

a. This fig., and proof, is original; it was devised by Joseph Zelson, a junior in West Phila., Pa., High School, and sent to me by his uncle, Louis G. Zelson, a teacher in a college near St. Louis, Mo., on May 5, 1939. It shows a high intellect and a fine mentality.

b. The proof Sixty-Eight, by a girl of 16, and the proof Sixty-Nine, by a boy of 18, are evidences that deductive reasoning is not beyond our youth.

Seventy

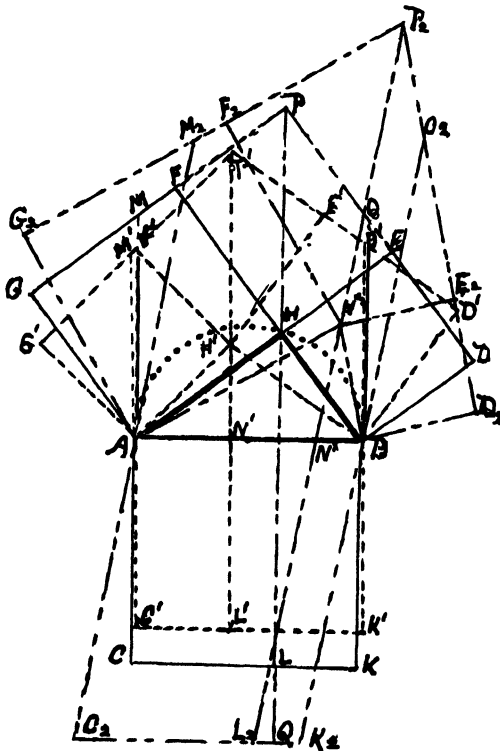


Fig. 170

Theorem.

If upon any convenient length, as AB , three triangles are constructed, one having the angle opposite AB obtuse, the second having that angle right, and the third having that opposite angle acute, and upon the sides including the obtuse, right and acute angle squares are constructed, then the sum of the three squares are, less than, equal to, or greater than the square constructed upon AB , according as the angle is obtuse, right or acute.

In fig. 170, upon AB as diameter describe the semicircumference BHA . Since all triangles whose vertex H' lies within the circumference BHA is obtuse at H' , all triangles whose vertex H lies on that circumference is right at H , and all triangles whose vertex H_2 lies without said circumference is acute at H_2 , let ABH' , ABH and ABH_2 be such triangles, and on sides BH' and AH' complete the squares $H'D'$ and $H'G'$; on sides BH and AH complete squares HD and HG ; on

sides BH_2 and AH_2 complete squares H_2D_2 and H_2G_2 . Determine the points P' , P and P_2 and draw $P'H'$ to L' making $N'L' = P'H'$, PH to L making $NL = PH$, and P_2H_2 to L_2 making $N_2L_2 = P_2H_2$.

Through A draw AC' , AC and AC_2 ; similarly draw BK' , BK and BK_2 ; complete the parallelograms AK' , AK and AK_2 .

Then the paral. $AK' = \text{sq. } H'D + \text{sq. } H'A'$. (See d under proof Forty-Two, and proof under fig. 143); the paral. (sq.) $AK = \text{sq. } HD + \text{sq. } HG$; and paral. $AK_2 = \text{sq. } H_2D_2 + \text{sq. } H_2G_2$.

Now the area of AK' is less than the area of AK if ($N'L' = P'H'$) is less than ($NL = PH$) and the area of AK_2 is greater than the area of AK if ($N_2L_2 = P_2H_2$) is greater than ($NL = PH$).

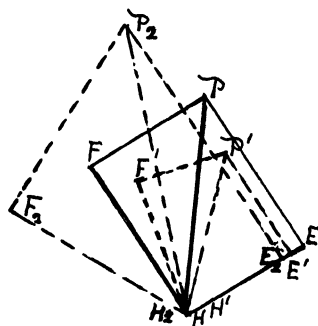


Fig. 171

In fig. 171 construct rect. $FHEP =$ to the rect. $FHEP$ in fig. 170, take $HF' = H'F$ in fig. 170, and complete $F'H'E'P'$; in like manner construct $F_2H_2E_2P_2$ equal to same in fig. 170. Since angle $AH'B$ is always obtuse, angle $E'H'F'$ is always acute, and the more acute $E'H'F'$ becomes, the shorter $P'H'$ becomes. Likewise, since angle AH_2B is always acute, angle $E_2H_2F_2$ is obtuse, and the more obtuse it becomes the

longer P_2H_2 becomes.

So first: As the variable acute angle $F'H'E'$ approaches its superior limit, 90° , the length $H'P'$ increases and approaches the length HP ; as said variable angle approaches, in degrees, its inferior limit, 0° , the length of $H'P'$ decreases and approaches, as its inferior limit, the length of the longer of the two lines $H'A$ or $H'B$, P' then coinciding with either E' or F' , and the distance of P' (now E' or F') from a line drawn through H' parallel to AB , will be the second dimension of the parallelogram AK' on AB ; as

said angle F'H'E' continues to decrease, H'P' passes through its inferior limit and increases continually and approaches its superior limit ∞ , and the distance of P' from the parallel line through the corresponding point of H' increases and again approaches the length HP.

\therefore said distance is always less than HP and the parallelogram AK' is always less than the sq. AK.

And secondly: As the obtuse variable angle $E_2H_2F_2$ approaches its inferior limit, 90° , the length of H_2P_2 decreases and approaches the length of HP; as said variable angle approaches its superior limit, 180° , the length of H_2P_2 increases and approaches ∞ in length, and the distance of P_2 from a line through the corresponding H_2 parallel to AB increases from the length HP to ∞ , which distance is the second dimension of the parallelogram A_2K_2 on AB.

\therefore the said distance is always greater than HP and the parallelogram AK_2 is always greater than the sq. AK.

\therefore the sq. upon AB = the sum of no other two squares except the two squares upon HB and HA.

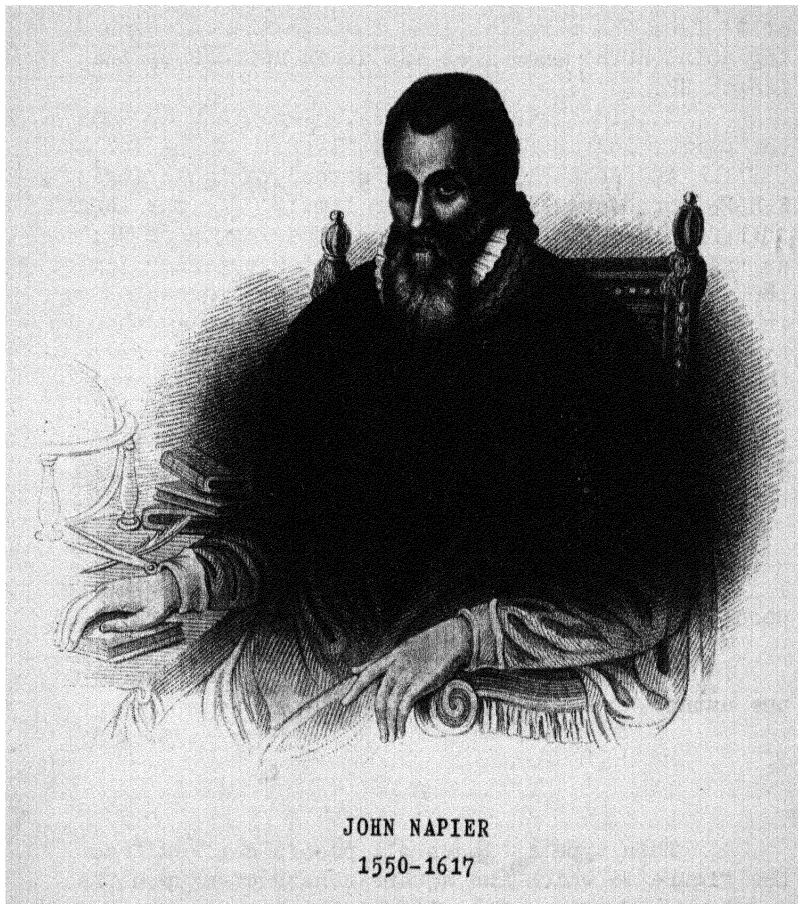
\therefore the sq. upon AB = the sq. upon BH + the sq. upon AH.

$$\therefore h^2 = a^2 + b^2, \text{ and never } a'^2 + b'^2.$$

a. This proof and figure was formulated by the author, Dec. 16, 1933.

B

This type includes all proofs derived from the figure in which the square constructed upon the hypotenuse overlaps the given triangle and the squares constructed upon the legs as in type A, and the proofs are based on the principle of equivalency.



JOHN NAPIER

1550-1617

Seventy-One

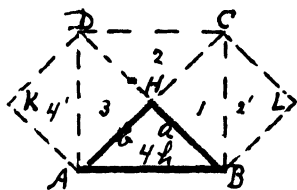


Fig. 172

Fig. 172 gives a particular proof. In rt. tri. ABH, legs AH and BH are equal. Complete sq. AC on AB, overlapping the tri. ABH, and extend AH and BH to C and D, and there results 4 equal equivalent tri's 1, 2, 3 and 4.

The sq. AC = tri's [(1 + 2 + 3 + 4), of which tri. 1 + tri. (2 = 2') = sq. BC, and tri. 3 + tri. (4 = 4') = sq. AD].
 \therefore sq. upon AB = sq. upon BH + sq. upon AH.
 $\therefore h^2 = a^2 + b^2$.

a. See fig. 73b and fig. 91 herein.

b This proof (better, illustration), by Richard . Bell, Feb. 22, 1938. He used only ABCD of fig. 172; also credited to Joseph Houston, a high school boy of South Bend, Ind., May 18, 1939. He used the full fig.

Seventy-Two

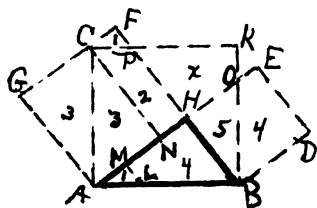


Fig. 173

Take AL = CP and draw LM and CN perp. to AH.

Since quad. CMNP = quad. KCOH, and quad. CNHP is common to both, then quad. PHOK = tri. CMN, and we have: sq. AK = (tri. ALM = tri. CPF of sq. HG) + (quad. LBHM = quad. OBDE of sq. HD) + (tri. OHB common to sq's AK and HD) + (quad. PHOK = tri. CGA of sq. HG) + (quad. CMHP common to sq's AK and HG) = sq. HD + sq. HG.
 \therefore sq. upon AB = sq. upon BH + sq. upon HA. $\therefore h^2 = a^2 + b^2$. Q.E.D.

a. This proof, with fig., discovered by the author March 26, 1934, 1 p.m.

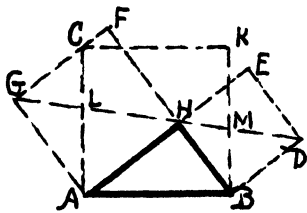
Seventy-Three

Fig. 174

Assuming the three squares constructed, as in fig. 174, draw GD--it must pass through H.

$$\begin{aligned} \text{Sq. AK} &= 2 \text{ trap. ABML} \\ &= 2 \text{ tri. AHL} + 2 \text{ tri. ABH} \\ &+ 2 \text{ tri. HBM} = 2 \text{ tri. AHL} \\ &+ 2(\text{tri. ACG} = \text{tri. ALG} + \text{tri. GLC}) \\ &+ 2 \text{ tri. HBM} = (2 \text{ tri. AHL} \\ &+ 2 \text{ tri. ALG}) + (2 \text{ tri. GLC} \\ &+ 2 \text{ tri. DMB}) + 2 \text{ tri. HBM} \end{aligned}$$

$$= \text{sq. AF} + \text{sq. BE.}$$

$$\therefore \text{sq. upon AB} = \text{sq. upon BH} + \text{sq. upon AH.}$$

$$\therefore h^2 = a^2 + b^2.$$

a. See Am. Math. Mo., V. IV, 1897, p. 250, proof XLIX.

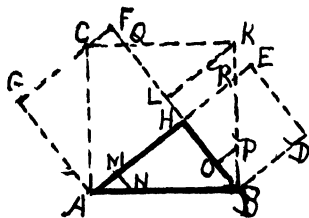
Seventy-Four

Fig. 175

Take $HM = HB$, and draw KL par. to AH and MN par. to BH .

$$\begin{aligned} \text{Sq. AK} &= \text{tri. ANM} \\ &+ \text{trap. MNBH} + \text{tri. BKL} + \text{tri. KQL} \\ &+ \text{quad. AHQC} = (\text{tri. CQF} \\ &+ \text{tri. ACG} + \text{quad. AHQC}) \\ &+ (\text{trap. RBDE} + \text{tri. BRH}) \\ &= \text{sq. AF} + \text{sq. HD.} \end{aligned}$$

$$\therefore \text{sq. upon AB} = \text{sq. upon BH} + \text{sq. upon AH.} \quad \therefore h^2 = a^2 + b^2.$$

a. See Am. Math. Mo., V. IV, 1897, p. 250, proof L.

b. If OP is drawn in place of MN , ($LO = HB$), the proof is prettier, but same in principle.

c. Also credited to R. A. Bell, Feb. 28, 1938.

Seventy-Five

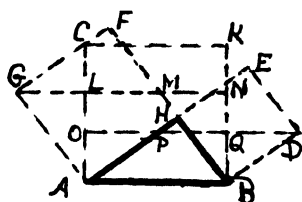


Fig. 176

In fig. 176, draw GN and OD par. to AB.

Sq. AK = rect. AQ + rect. OK = paral. AD + rect. AN = sq. BE + paral. AM = sq. HD + sq. HG.

\therefore sq. upon AB = sq. upon BH + sq. upon AH. $\therefore h^2 = a^2 + b^2$.

a. See Am. Math. Mo., V. IV, 1897, p. 250, XLVI.

Seventy-Six

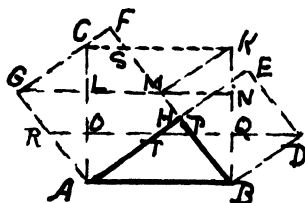


Fig. 177

In fig. 177, draw GN and DR par. to AB and LM par. to AH. R is the pt. of intersection of AG and DO.

Sq. AK = rect. AQ + rect. ON + rect. LK = (paral. DA = sq. BE) + (paral. RM = pentagon RTHMG + tri. CSF) + (paral. GMKC = trap. GMSC + tr. TRA) = sq. BE + sq. AF.

\therefore sq. upon AB = sq. upon BH + sq. upon AH. $\therefore h^2 = a^2 + b^2$.

a. See Am. Math. Mo., V. IV, 1897, p. 250, proof XLVII; Versluys, 1914, p. 12, fig. 7.

Seventy-Seven

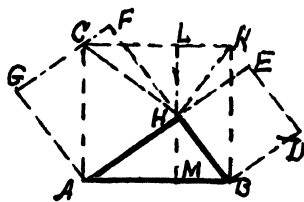


Fig. 178

In fig. 178, draw LM through H perp. to AB, and draw HK and HC.

Sq. AK = rect. LB + rect. LA = 2 tri. KHB + 2 tri. CAH = sq. AD + sq. AF.

\therefore sq. upon AB = sq. upon BH + sq. upon AH.

$$\therefore h^2 = a^2 + b^2.$$

a. Versluys, 1914, p. 12, fig. 7; Wipper, 1880, p. 12, proof V; Edw. Geometry, 1895, p. 159, fig. 23; Am. Math. Mo., Vol. IV, 1897, p. 250, proof LXVIII; E. Fourrey, Curiosities of Geometry, 2nd Ed'n, p. 76, fig. e, credited to Peter Warins, 1762.

Seventy-Eight

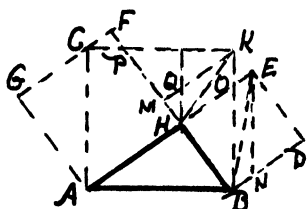


Fig. 179

Draw HL par. to BK, KM par. to HA, KH and EB.

$$\begin{aligned} \text{Sq. AK} &= (\text{tri. ABH} \\ &= \text{tri. ACG}) + \text{quad. AHPC com-} \\ &\text{mon to sq. AK and sq. AF} \\ &+ (\text{tri. HQM} = \text{tri. CPF}) + (\text{tri.} \\ &\text{KPM} = \text{tri. END}) + [\text{paral. QHOK} \\ &= 2(\text{tri. HOK} = \text{tri. KHB} - \text{tri.} \\ &\text{OHB} = \text{tri. EHB} - \text{tri. OHB} \\ &= \text{tri. EOB}) = \text{paral. OBNE}] \end{aligned}$$

+ tri. OHB common to sq. AK and sq. HD.

$$\therefore \text{sq. AK} = \text{sq. HD} + \text{sq. AF.}$$

$$\therefore \text{sq. upon AB} = \text{sq. upon BH} + \text{sq. upon AH.}$$

$$\therefore h^2 = a^2 + b^2.$$

a. See Am. Math. Mo., V. IV, 1897, p. 250, proof LI.

b. See Sci. Am. Sup., V. 70, 1910, p. 382, for a geometric proof, unlike the above proof, but based upon a similar figure of the B type.

Seventy-Nine

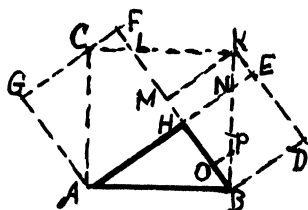


Fig. 180

In fig. 180, extend DE to K, and draw KM perp. to FB.

$$\begin{aligned} \text{Sq. AK} &= (\text{tri. ABH} \\ &= \text{tri. ACG}) + \text{quad. AHLK com-} \\ &\text{mon to sq. AK and sq. AF} \\ &+ [(\text{tri. KLM} = \text{tri. BNH}) \\ &+ \text{tri. BKM} = \text{tri. KBD} = \text{trap.} \\ &\text{BDEN} + (\text{tri. KNE} = \text{tri. CLF})]. \\ \therefore \text{sq. AK} &= \text{sq. BE} + \text{sq. AF.} \end{aligned}$$

\therefore sq. upon AB = sq. upon BH + sq. upon AH.
 $\therefore h^2 = a^2 + b^2$.

a. See Edwards' Geom., 1895, p. 161, fig. (36); Am. Math. Mo., V. IV, 1897, p. 251, proof LII; Versluys, 1914, p. 36, fig. 35, credited to Jenny de Buck.

Eighty

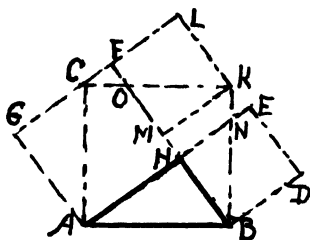


Fig. 181

In fig. 181, extend GF to L making FL = HB and draw KL and KM respectively par. to BH and AH.

Sq. AK = (tri. ABH = tri. CKL " trap. BDEN + tri. COF) + (tri. BKM = tri. ACG) + (tri. KOM = tri. BNH) + quad. AHOC common to sq. AK and sq. HD + sq. HG.

\therefore sq. upon AB = sq. upon BH + sq. upon AH. $\therefore h^2 = a^2 + b^2$.

a. See Am. Math. Mo., V. IV, 1897, p. 251, proof LVII.

Eighty-One

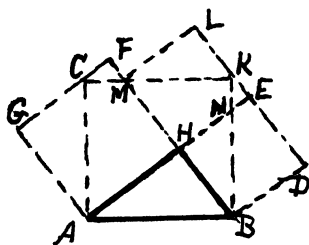


Fig. 182

In fig. 182, extend DE to L making KL = HN, and draw ML.

Sq. AK = (tri. ABH = tri. ACG) + (tri. BMK = $\frac{1}{2}$ rect. BL = [trap. BDEN + (tri. MKL = tri. BNH)]) + quad. AHMC common to sq. AK and sq. AF = sq. HD + sq. HG.

\therefore sq. upon AB = sq. upon BH + sq. upon AH. $\therefore h^2 = a^2 + b^2$.

a. See Edwards' Geom., 1895, p. 158, fig.

(18).

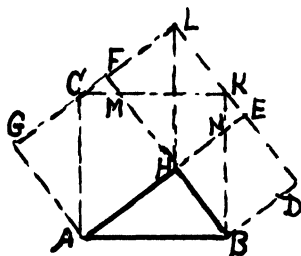
Eighty-Two

Fig. 183

In fig. 183, extend GF and DE to L and draw LH.

Sq. AK = hexagon AHBKLC
+ paral. HK + paral. HC = sq.
HD + sq. HG.

\therefore sq. upon AB = sq.
upon BH + sq. upon AH. $\therefore h^2$
= $a^2 + b^2$.

a. Original with the author, July 7, 1901; but old for it appears in Olney's Geom., university edition, 1872, p.

250, fig. 374; Jury Wipper, 1880, p. 25, fig. 20b, as given by M. v. Ash, in "Philosophical Transactions," 1683; Math. Mo., V. IV, 1897, p. 251, proof LV; Heath's Math. Monographs, No. 1, 1900, p. 24, proof IX; Versluys, 1914, p. 55, fig. 58, credited to Henry Bond. Based on the Theorem of Pappus. Also see Dr. Leitzmann, p. 21, fig. 25, 4th Edition.

b. By extending LH to AB, an algebraic proof can be readily devised, thus increasing the no. of simple proofs.

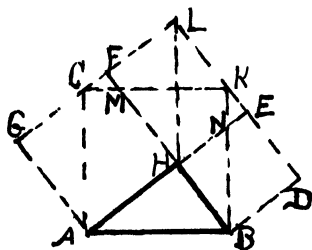
Eighty-Three

Fig. 184

In fig. 184, extend GF and DE to L, and draw LH.

Sq. AK = pentagon ABDLG
- (3 tri. ABH = tri. ABH + rect.
LH) + sq. HD + sq. AF.

\therefore sq. upon AB = sq.
upon BH + sq. upon AH. $\therefore h^2$
= $a^2 + b^2$.

a. See Journal of Education, 1887, V. XXVI, p. 21, fig. X; Math. Mo., 1855, Vol. II, No. 2, Dem. 12, fig. 2.

Eighty-Four

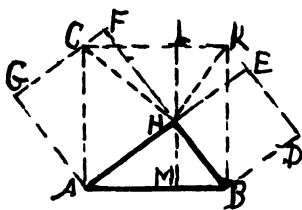


Fig. 185

In fig. 185, extend H draw LM perp. to AB, and draw HK and HC.

$$\begin{aligned} \text{Sq. AK} &= \text{rect. LB} \\ + \text{rect. LA} &= 2 \text{ tri. HBK} + 2 \text{ tri.} \\ \text{AHC} &= \text{sq. HD} + \text{sq. HG.} \\ \therefore \text{sq. upon AB} &= \text{sq.} \\ \text{upon BH} + \text{sq. upon AH.} &\therefore h^2 \\ &= a^2 + b^2. \end{aligned}$$

a. See Sci. Am. Sup., V. 70, p. 383, Dec. 10, 1910, being No. 16 in A. R. Colburn's 108 proofs; Fourrey, p. 71, fig. e.

Eighty-Five

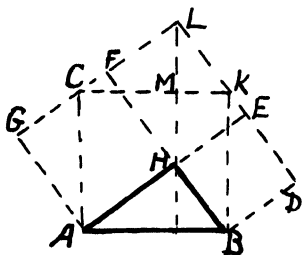


Fig. 186

In fig. 186, extend GF and DE to L, and through H draw LN, N being the pt. of intersection of NH and AB.

$$\begin{aligned} \text{Sq. AK} &= \text{rect. MB} \\ + \text{rect. MA} &= \text{paral. HK} + \text{paral.} \\ \text{HC} &= \text{sq. HD} + \text{sq. HG.} \\ \therefore \text{sq. upon AB} &= \text{sq.} \\ \text{upon BH} + \text{sq. upon AH.} &\therefore h^2 \\ &= a^2 + b^2. \end{aligned}$$

a. See Jury Wipper, 1880, p. 13, fig. 5b, and p. 25, fig. 21, as given by Klage1 in "Encyclopaedie," 1808; Edwards' Geom., 1895, p. 156, fig. (7); Ebene Geometrie, von G. Mahler, 1897, p. 87, art. 11; Am. Math. Mo., V. IV, 1897, p. 251, LIII; Math. Mo., 1859, Vol. II, No. 2, fig. 2, Dem. 2, pp. 45-52, where credited to Charles A. Young, Hudson, O., now Dr. Young, astronomer, Princeton, N.J. This proof is an application of Prop. XXXI, Book IV, Davies Legendre; also Ash, M. v. of Dublin; also Joseph Zelson, Phila., Pa., a student in West Chester High School, 1939.

b. This figure will give an algebraic proof.

Eighty-Six

In fig. 186 it is evident that sq. AK = hexagon ABDKCG - 2 tri. BDK = hexagon AHBKLC = (paral. KH = rect. KN) + paral. CH = rect. CN) = sq. HD + sq. HG. \therefore sq. upon AB = sq. upon BH + sq. upon AH. $\therefore h^2 = a^2 + b^2$. Q.E.D.

a. See Math. Mo., 1858, Vol. I, p. 354, Dem. 8, where it is credited to David Trowbridge.

b. This proof is also based on the Theorem of Pappus. Also this geometric proof can easily be converted into an algebraic proof.

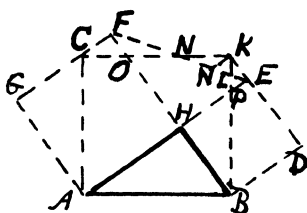
Eighty-Seven

Fig. 187

In fig. 187, extend DE to K, draw FE, and draw KM par. to AH.

Sq. AK = (tri. ABH = tri. ACG) + quad. AHOC common to sq. AK and sq. AK + tri. BLH common to sq. AK and sq. HD + [quad. OHLK = pentagon OHLPN + (tri. PMK = tri. PLE) + (tri. MKN = tri. ONF) = tri.

HEF = (tri. BDK = trap. BDEL + (tri. COF = tri. LEK)] = sq. HD + sq. HG.

\therefore sq. upon AB = sq. upon HD + sq. upon HG.

$\therefore h^2 = a^2 + b^2$. Q.E.D.

a. See Am. Math. Mo., V. IV, 1897, p. 251, proof LVI.

Eighty-Eight

In fig. 188, extend GF and BK to L, and through H draw MN par. to BK, and draw KM.

Sq. AK = paral. AOLC = paral. HL + paral. HC = (paral. HK = sq. AD) + sq. HG.

\therefore sq. upon AB = sq. upon BH + sq. upon AH.

$\therefore h^2 = a^2 + b^2$.

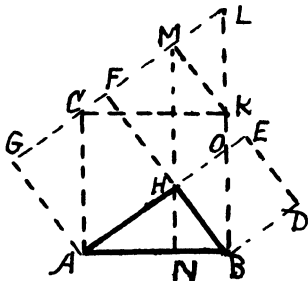


Fig. 188

a. See Jury Wipper, 1880, p. 27, fig. 23, where it says that this proof was given to Joh. Hoffmann, 1800, by a friend; also *Am. Math. Mo.*, 1897, V. IV, p. 251, proof LIV; Versluys, p. 20, fig. 16, and p. 21, fig. 18; Fourrey, p. 73, fig. b.

b. From this figure an algebraic proof is easily devised.

c. Omit line MN and we have R. A. Bell's fig. and a proof by congruency follows. He found it Jan. 31, 1922.

Eighty-Nine

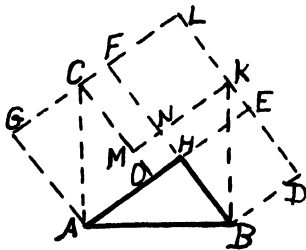


Fig. 189

Extend GF to L making FL = BH, draw KL, and draw CO par. to FB and KM par. to AH.

Sq. AK = (tri. ABH = tri. ACG) + tri. CAO common to sq's AK and HG + sq. MH common to sq's AK and HG + [pentagon MNBKC = rect. ML + (sq. NL = sq. HD)] = sq. HD + sq. HG.

\therefore sq. upon AB = sq. upon BH + sq. upon HA. $\therefore h^2 = a^2 + b^2$. Q.E.D.

a. Devised by the author, July 30, 1900, and afterwards found in Fourrey, p. 84, fig. c.

Ninety

In fig. 190 produce GF and DE to L, and GA and DB to M. Sq. AK + 4 tri. ABH = sq. GD = sq. HD + sq. HG + (rect. HM = 2 tri. ABH) + (rect. LH = 2 tri. ABH) whence sq. AK = sq. HD + sq. HG.

\therefore sq. upon AB = sq. upon BH + sq. upon AH. $\therefore h^2 = a^2 + b^2$.

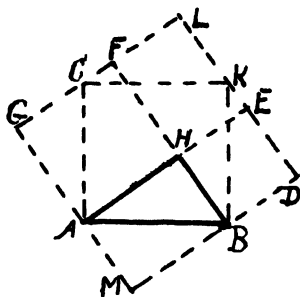
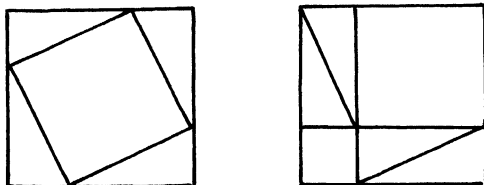


Fig. 190

Society of Canada, wherein the figure appears as follows:



LOOK

Fig. 191

Ninety-One

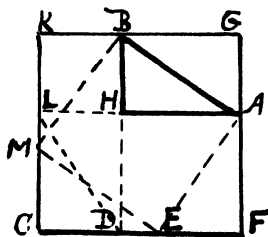


Fig. 192

Tri's BAG, MBK, EMC, AEF, LDH and DLC are each = to tri. ABH.
 \therefore sq. AM = (sq. KF - 4 tri. ABH) = [(sq. KH + sq. HF + 2 rect. GH) - 4 tri. ABH] = sq. KH + sq. HF.
 \therefore sq. upon AB = sq. upon HB + sq. upon HA. $\therefore h^2 = a^2 + b^2$.

a. See P. C. Cullen's pamphlet, 11 pages, with title,

"The Pythagorean Theorem; or a New Method of Demonstrating it." Proof as above. Also Fourrey, p. 80, as the demonstration of Pythagoras according to Bretschensneider; see Simpson, and Elements of Geometry, Paris, 1766.

b. In No. 2, of Vol. I, of Scientia Baccalaureus, p. 61, Dr. Wm. B. Smith, of the Missouri State University, gave this method of proof as new. But, see "School Visitor," Vol. II, No. 4, 1881, for same demonstration by Wm. Hoover, of Athens, O., as "adapted from the French of Dalseme." Also see "Math. Mo.," 1859, Vol. I, No. 5, p. 159; also the same journal, 1859, Vol. II, No. 2, pp. 45-52, where Prof. John M. Richardson, Collegiate Institute, Boudon, Ga., gives a collection of 28 proofs, among which, p. 47, is the one above, ascribed to Young.

See also Orlando Blanchard's Arithmetic, 1852, published at Cazenovia, N.Y., pp. 239-240; also Thomas Simpson's "Elements of Geometry," 1760, p. 33, and p. 31 of his 1821 edition.

Prof. Saradaranjan Ray of India gives it on pp. 93-94 of Vol. I, of his Geometry, and says it "is due to the Persian Astronomer Nasir-uddin who flourished in the 13th century under Jengis Khan."

Ball, in his "Short History of Mathematics," gives same method of proof, p. 24, and thinks it is probably the one originally offered by Pythagoras.

Also see "Math. Magazine," by Artemas Martin, LL.D., 1892, Vol. II, No. 6, p. 97. Dr. Martin says: "Probably no other theorem has received so much attention from Mathematicians or been demonstrated in so many different ways as this celebrated proposition, which bears the name of its supposed discoverer."

c. See T. Sundra Row, 1905, p. 14, by paper folding, "Reader, take two equal squares of paper and a pair of scissors, and quickly may you know that $AB^2 = BH^2 + HA^2$."

Also see Versluys, 1914, his 96 proofs, p. 41, fig. 42. The title page of Versluys is:

ZES EN NEGENTIG BEWIJZEN

Voor Het

THEOREMA VAN PYTHAGORAS

Verzameld en Gerangschikt

Door

J. VERSLUYS

Amsterdam--1914

- - -

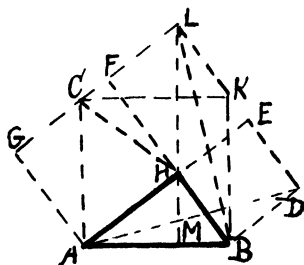
Ninety-Two

Fig. 193

In fig. 193, draw KL par. and equal to BH, through H draw LM par. to BK, and draw AD, LB and CH.

Sq. AK = rect. MK
 + rect. MC = (paral. HK = 2
 tri. BKL = 2 tri. ABD = sq.
 BE) + (2 tri. AHC = sq. AF).
 \therefore sq. upon AB = sq.
 upon BH + sq. upon AH. $\therefore h^2$
 $= a^2 + b^2$.

a. This figure and proof is taken from the following work, now in my library, the title page of which is shown on the following page.

The figures of this book are all grouped together at the end of the volume. The above figure is numbered 62, and is constructed for "Propositio XLVII," in "Librum Primum," which proposition reads, "In rectangulis triangulis, quadratum quod a latere rectum angulum subtendente describitur; aequale est eis, quae a lateribus rectum angulum continentibus describuntur quadratis."

"Euclides Elementorum Geometricorum
 Libros Tredecim
 Isidorum et Hypsiclem
 & Recentiores de Corporibus Regularibus, &
 Procli
 Propositiones Geometricas

- - - - -
 - - - - -
 - - - - -
 - - - - -

Claudius Richards

e Societate Jesu Sacerdos, patria Ornacensis in libero Comitatu
 Burgundae, & Regius Mathematicarum

Professor: dicantique

Philippo IIII. Hispaniarum et Indicarum Regi Cathilico.

Antwerpiae,

ex Officina Hiesonymi Verdussii. M.DC.XLV.

Cum Gratia & Privilegio"

- - -

Then comes the following sentence:

"Proclus in hunc librum, celebrat Pythagoram
 Authorem huius propositionis, pro cuius demonstra-
 tione dicitur Diis Sacrificasse hecatombam Taurorum."
 Following this comes the "Supposito," then the "Con-
 structio," and then the "Demonstratio," which con-
 densed and translated is: (as per fig. 193) triangle
 BKL equals triangle ABD; square BE equals twice tri-
 angle ABM and rectangle MK equals twice triangle BKL;
 therefore rectangle MK equals square BE. Also square
 AG equals twice triangle AHC; rectangle HM equals
 twice triangle CAH; therefore square AG equal rectan-
 gle HM. But square BK equals rectangle KM plus rec-
 tangle CM. Therefore square BK equals square AG plus
 square BD.

The work from which the above is taken is a book of 620 pages, 8 inches by 12 inches, bound in vellum, and, though printed in 1645 A.D., is well preserved. It once had a place in the Sunderland Library, Blenheim Palace, England, as the book plate shows--on the book plate is printed--"From the Sunderland Library, Blenheim Palace, Purchased, April, 1882."

The work has 408 diagrams, or geometric figures, is entirely in Latin, and highly embellished.

I found the book in a second-hand bookstore in Toronto, Canada, and on July 15, 1891, I purchased it. (E. S. Loomis.)

C

This type includes all proofs derived from the figure in which the square constructed upon the longer leg overlaps the given triangle and the square upon the hypotenuse.

Proofs by dissection and superposition are possible, but none were found.

Ninety-Three

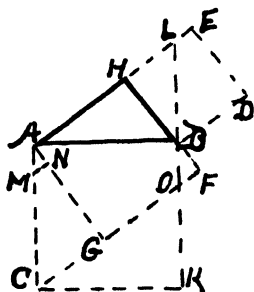


Fig. 194

In fig. 194, extend KB to L, take GN = BH and draw MN par. to AH. Sq. AK = quad. AGOB common to sq's AK and AF + (tri. COK = tri. ABH + tri. BLH) + (trap. CGNM = trap. BDEL) + (tri. AMN = tri. BOF) = sq. HD + sq. HG.

\therefore sq. upon AB = sq. upon BH + sq. upon AH. $\therefore h^2 = a^2 + b^2$.

a. See Am. Math. Mo., V.

IV, 1897, p. 268, proof LIX.

b. In fig. 194, omit MN and draw KR perp. to OC; then take KS = BL and draw ST perp. to OC. Then the fig. is that of Richard A.

Bell, of Cleveland, O., devised July 1, 1918, and given to me Feb. 28, 1938, along with 40 other proofs through dissection, and all derivation of proofs by Mr. Bell (who knows practically nothing as to Euclidian Geometry) are found therein and credited to him, on March 2, 1938. He made no use of equivalency.

Ninety-Four

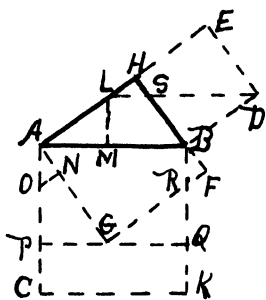


Fig. 195

In fig. 195, draw DL par. to AB, through G draw PQ par. to CK, take GN = BH, draw ON par. AH and LM perp. to AB.

Sq. AK = quad. AGRB common to sq's AK and AF + (tri. ANO = tri. BRF) + (quad. OPGN = quad. LMBS) + (rect. PK = paral. AB DL = sq. BE) + (tri. GRQ = tri. AML) = sq. BE + sq. AF.

\therefore sq. upon AB = sq. upon BH + sq. upon AH. $\therefore h^2 = a^2 + b^2$.

a. Devised by the author, July 20, 1900.

Ninety-Five

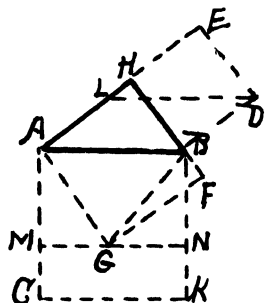


Fig. 196

In fig. 196, through G and D draw MN and DL each par. to AB, and draw GB.

Sq. AK = rect. MK + rect. MB = paral. AD + 2 tri. BAG = sq. BE + sq. AF.

\therefore sq. upon AB = sq. upon BH + sq. upon AH. $\therefore h^2 = a^2 + b^2$.

a. See Am. Math. Mo., V. IV, 1897, p. 268, proof LXII.

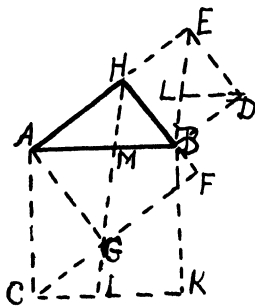
Ninety-Six

Fig. 197

In fig. 197, extend FG to G, draw EB, and through C draw HN, and draw DL par. to AB.

Sq. AK = 2[quad. ACNM
= (tri. CGN = tri. DBL) + tri.
AGM common to sq. AK and AF
+ (tri. ACG = tri. ABH = tri. AMH
+ tri. ELD)] = 2 tri. AGH + 2
tri. BDE = sq. HD + sq. HG.

\therefore sq. upon AB = sq. upon
BH + sq. upon AH. $\therefore h^2 = a^2 + b^2$.

a. See Am. Math. Mo., V.
IV, 1897, p. 268, proof LXIII.

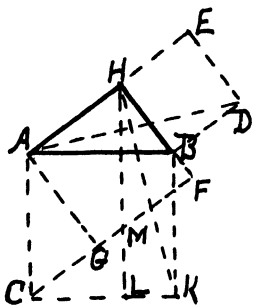
Ninety-Seven

Fig. 198

In fig. 198, extend FG to G, draw HL par. to AC, and draw AD and HK. Sq. AK = rect. BL + rect. AL = (2 tri. KBH = 2 tri. ABD + paral. ACMH) = sq. BE + sq. AF.

\therefore sq. upon AB = sq. upon
BH + sq. upon AH. $\therefore h^2 = a^2 + b^2$.

a. See Jury Wipper, 1880,
p. 11, II; Am. Math. Mo., V. IV,
1897, p. 267, proof LVIII; Four-
rey, p. 70, fig. b; Dr. Leitz-
mann's work (1920), p. 30, fig.
31.

Ninety-Eight

In fig. 199, through G draw MN par. to AB, draw HL perp. to CK, and draw AD, HK and BG.

Sq. AK = rect. MK + rect. AN = (rect. BL = 2 tri. KBH = 2 tri. ABD) + 2 tri. AGB = sq. BE + sq. AF.

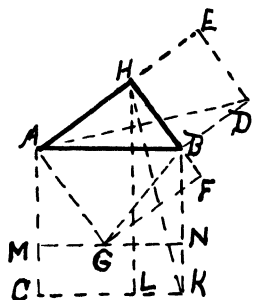


Fig. 199

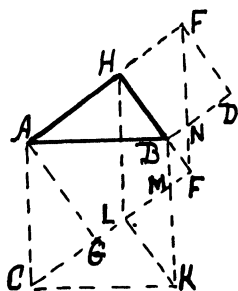


Fig. 200

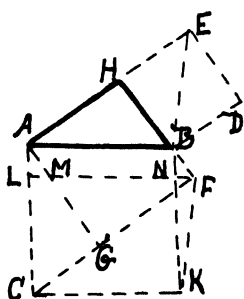


Fig. 201

\therefore sq. upon AB = sq. upon BH + sq. upon AH. $\therefore h^2 = a^2 + b^2$.

a. See Am. Math. Mo., V. IV, 1897, p. 268, proof LXI.

Ninety-Nine

In fig. 200, extend FG to C, draw HL par. to BK, and draw EF and LK. Sq. AK = quad. AGMB common to sq's AK and AF + (tri. ACG = tri. ABH) + (tri. CKL = trap. EHBN + tri. BMF) + (tri. KML = tri. END) = sq. HD + sq. HG.

\therefore sq. upon AB = sq. upon BH + sq. upon AH. $\therefore h^2 = a^2 + b^2$.

a. See Am. Math. Mo., V. IV, 1897, p. 268, proof LXIV.

One Hundred

In fig. 201, draw FL par. to AB, extend FG to C, and draw EB and FK. Sq. AK = (rect. LK = 2 tri. CKF = 2 tri. ABE = 2 tri. ABH + tri. HBE = tri. ABH + tri. FMG + sq. HD) + (rect. AN = paral. MB).

\therefore sq. upon AB = sq. upon BH + sq. upon AH. $\therefore h^2 = a^2 + b^2$.

a. See Am. Math. Mo., V. IV, 1897, p. 269, proof LXVII.

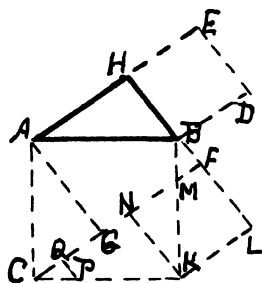


Fig. 202

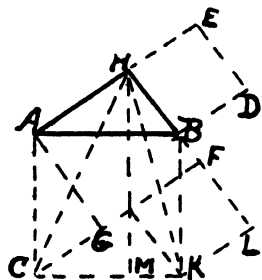


Fig. 203

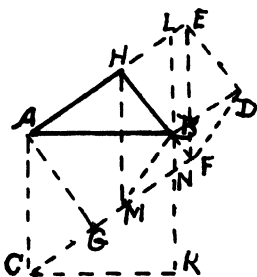


Fig. 204

One Hundred One

In fig. 202, extend FG to C, HB to L, draw KL par. to AH, and take NO = BH and draw OP and NK par. to BH.

Sq. AK = quad. AGMB common to sq's AK and AF + (tri. ACG = tri. ABH) + (tri. CPO = tri. BMF) + (trap. PKNO + tri. KMN = sq. NL = sq. HD) = sq. HD + sq. AF.

\therefore sq. upon AB = sq. upon BH + sq. upon AH. $\therefore h^2 = a^2 + b^2$.

a. See Edwards' Geom., 1895, p. 157, fig. (14).

One Hundred Two

In fig. 203, extend HB to L making FL = BH, draw HM perp. to CK and draw HC and HK.

Sq. AK = rect. BM + rect. AM = 2 tri. KBH + 2 tri. HAC = sq. HD + sq. HG.

\therefore sq. upon AB = sq. upon BH + sq. upon AH. $\therefore h^2 = a^2 + b^2$.

a. See Edwards' Geom., 1895, p. 161, fig. (37).

One Hundred Three

Draw HM, LB and EF par. to BK. Join CG, MB and FD.

Sq. AK = paral. ACNL = paral. HN + paral. HC = (2 tri. BHM = 2 tri. DEF = sq. HD) + sq. HG = sq. HD + sq. HG.

\therefore sq. upon AB = sq. upon BH + sq. upon AH. $\therefore h^2 = a^2 + b^2$.

a. See Am. Math. Mo., V. IV, 1897, p. 269, proof IXIX.

One Hundred Four

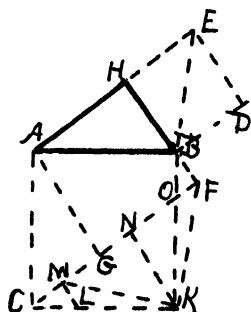


Fig. 205

In fig. 205, extend FG to C, draw KN par. to BH, take NM = BH, draw ML par. to HB, and draw MK, KF and BE.

Sq. AK = quad. AGOB common to sq's AK and AF + (tri. ACG = tri. ABH) + (tri. CLM = tri. BOF) + [(tri. LKM = tri. OKF) + tri. KON = tri. BEH] + (tri. MKN = tri. EBD) = (tri. BEH + tri. EBD) + (quad. AGOB + tri. BOF + tri. ABC) = sq. HD + sq. HG.

\therefore sq. upon AB = sq. upon BH + sq. upon AH. $\therefore h^2 = a^2 + b^2$.

a. See Math. Mo., V. IV, 1897, p. 269, proof LXVIII.

One Hundred Five

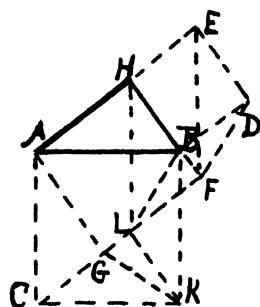


Fig. 206

In fig. 206, extend FG to H, draw HL par. to AC, KL par. to HB, and draw KG, LB, FD and EF.

Sq. AK = quad. AGLB common to sq's AK and AF + (tri. ACG = tri. ABH) + (tri. CKG = tri. EFD = $\frac{1}{2}$ sq. HD) + (tri. GKL = tri. BLF) + (tri. BLK = $\frac{1}{2}$ paral. HK = $\frac{1}{2}$ sq. HD) = ($\frac{1}{2}$ sq. HD + $\frac{1}{2}$ sq. HD) + (quad. AGLB + tri. ABH + tri. BLF) = sq. HD + sq. AF.

\therefore sq. upon AB = sq. upon BH + sq. upon AH. $\therefore h^2 = a^2 + b^2$.

a. See Am. Math. Mo., V. IV, 1897, p. 268, proof LXV.

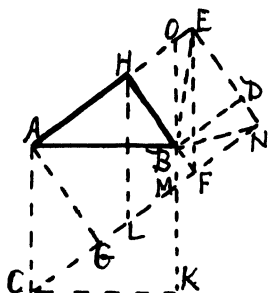
One Hundred Six

Fig. 207

In fig. 207, extend FG to C and N, making FN = BD, KB to O, (K being the vertex opp. A in the sq. CB) draw FD, FE and FB, and draw HL par. to AC.

Sq. AK = paral. ACMO
 = paral. HM + paral. HC = [(paral. EHLF = rect. EF) - (paral. EOMF = 2 tri. EBF = 2 tri. DBF = rect. DF)] = sq. HD + sq. AF.

\therefore sq. upon AB = sq. upon BH + sq. upon AH. $\therefore h^2 = a^2 + b^2$.

a. See Am. Math. Mo., V. IV, 1897, p. 268, proof LXVI.

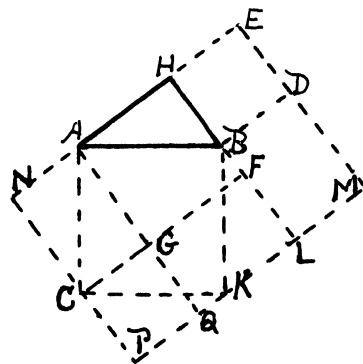
One Hundred Seven

Fig. 208

In fig. 208, through C and K draw NP and PM par. respectively to BH and AH, and extend ED to M, HF to L, AG to Q, HA to N and FG to C.

Sq. AK + rect. HM + 4 tri. ABH = rect. NM = sq. HD + sq. HG + (rect. NQ = rect. HM) + (rect. GL = 2 tri. ABH) + (rect. BM = 2 tri. ABH).

\therefore sq. AK = sq. HD + sq. HG. $\therefore h^2 = a^2 + b^2$.
 Q.E.D.

\therefore sq. upon AB = sq. upon BH + sq. upon AH.
 $\therefore h^2 = a^2 + b^2$.

a. Credited by Joh. Hoffmann, in "Der Pythagoräische Lehrsatz," 1821, to Henry Boad of London; see Jury Wipper, 1880, p. 19, fig. 13.

One Hundred Eight

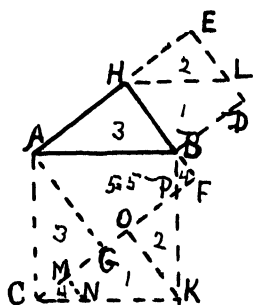


Fig. 209

By dissection. Draw HL par. to AB, CF par. to AH and KO par. to BH. Number parts as in figure.

Whence: sq. AK = parts [(1 + 2) = (1 + 2) in sq. HD]] + parts [(3 + 4 + 5) = (3 + 4 + 5) in sq. HG]] = sq. HD + sq. HG.
 \therefore sq. upon AB = sq. upon HD + sq. upon HA. $\therefore h^2 = a^2 + b^2$.
 Q.E.D.

a. Devised by the author to show a proof of Type-C figure, by dissection, Dec. 1933.

D

This type includes all proofs derived from the figure in which the square constructed upon the shorter leg overlaps the given triangle and the square upon the hypotenuse.

One Hundred Nine

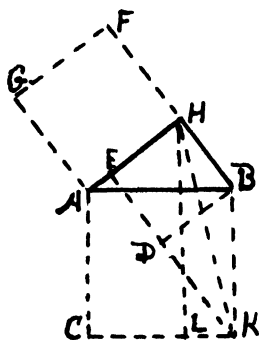


Fig. 210

In fig. 210, extend ED to K, draw HL perp. to CK and draw HK.

Sq. AK = rect. BL + rect. AL = (2 tri. BHK = sq. HD) + (sq. HE by Euclid's proof).
 \therefore sq. upon AB = sq. upon BH + sq. upon AH. $\therefore h^2 = a^2 + b^2$.

a. See Jury Wipper, 1880, p. 11, fig. 3; Versluys, p. 12, fig. 4, given by Hoffmann.

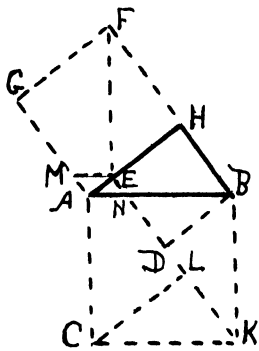
One Hundred Ten

Fig. 211

In fig. 211, extend ED to K, draw CL par. to AH, EM par. to AB and draw FE.

Sq. AK = (quad. ACLN
= quad. EFGM) + (tri. CKL = tri.
ABH = trap. BHEN + tri. EMA)
+ (tri. KBD = tri. FEH) + tri.
BND common to sq's AK and HD
= sq. HD + sq. AF.

\therefore sq. upon AB = sq. upon
BH + sq. upon AH. $\therefore h^2 = a^2 + b^2$.

a. See Edwards' Geom.,
1895, p. 155, fig. (2).

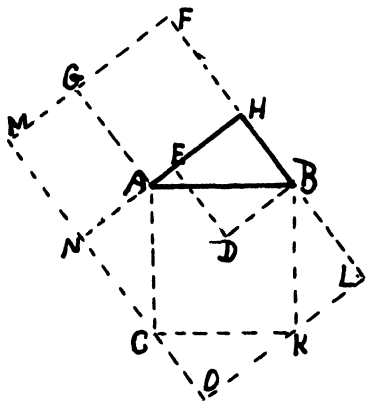
One Hundred Eleven

Fig. 212

In fig. 212, extend FB and FG to L and M making BL = AH and GM = BH, complete the rectangle FO and extend HA to N, and ED to K.

Sq. AK + rect. MH
+ 4 tri. ABH = rect. FO
= sq. HD + sq. HG + (rect.
NK = rect. MH) + (rect. MA
= 2 tri. ABH) + (rect. DL
= 2 tri. ABH); collecting
we have sq. AK = sq. HD
+ sq. HG.

\therefore sq. upon AB = sq.
upon BH + sq. upon AH.
 $\therefore h^2 = a^2 + b^2$.

a. Credited to Henry Boad by Joh. Hoffmann,
1821; see Jury Wipper, 1880, p. 20, fig. 14.

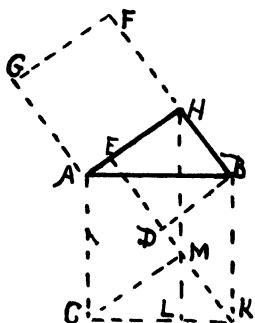
One Hundred Twelve


Fig. 213

In fig. 213, extend ED to K, draw HL par. to AC, and draw CM.

Sq. AK = rect. BL + rect. AL = paral. HK + paral. HC = sq. HD + sq. HG.

\therefore sq. upon AB = sq. upon BH + sq. upon AH. $\therefore h^2 = a^2 + b^2$.

a. Devised by the author, Aug. 1, 1900.

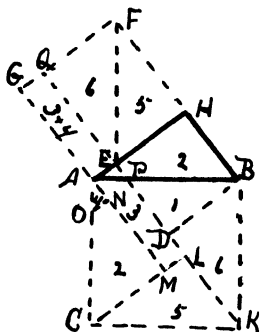
One Hundred Thirteen


Fig. 214

In fig. 214, extend ED to K and Q, draw CL perp. to EK, extend GA to M, take MN = BH, draw NO par. to AH, and draw FE.

Sq. AK = (tri. CKL = tri. FEH) + (tri. KBD = tri. EFQ) + (trap. AMLP + tri. AON = rect. GE) + tri. BPD common to sq's AK and BE + (trap. CMNO = trap. BHEP) = sq. HD + sq. HG.

\therefore sq. upon AB = sq. upon BH + sq. upon AH. $\therefore h^2 = a^2 + b^2$.

a. Original with the author, Aug. 1, 1900.

One Hundred Fourteen

Employ fig. 214, numbering the parts as there numbered, then, at once: sq. AK = sum of 6 parts [(1 + 2 = sq. HD) + (3 + 4 + 5 + 6 = sq. HG) = sq. HD + sq. HG].

\therefore sq. upon AB = sq. upon HB + sq. upon HA.
 $\therefore h^2 = a^2 + b^2$. Q.E.D.

a. Formulated by the author, Dec. 19, 1933.

One Hundred Fifteen

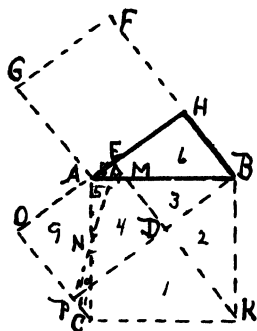


Fig. 215

In fig. 215, extend HA to O making OA = HB, ED to K, and join OC, extend BD to P and join EP. Number parts 1 to 11 as in figure. Now: sq. AK = parts 1 + 2 + 3 + 4 + 5; trapezoid EPCK = $\frac{EK + PC}{2} \times PD = KD \times PD = AH \times$

AG = sq. HG = parts 7 + 4 + 10

+ 11 + 1. Sq. HD = parts 3 + 6.

\therefore sq. AK = 1 + 2 + 3 + 4

+ 5 = 1 + (2 = 6 + 7 + 8) + 3 + 4

+ 5 = 1 + (6 + 3) + 7 + 8 + 4 + 5

= 1 + (6 + 3) + (7 + 8 = 11) + 4

+ 5 = 1 + (6 + 3) + 11 + 4 + 5

= 1 + (6 + 3) + 11 + 4 + (5 = 2 + 4, since 5 + 4 + 3

= 2 + 3) = 1 + (6 + 3) + 11 + 4 + 2 + 4 = 1 + (6 + 3)

+ 11 + 4 + (2 = 7 + 4 + 10) - 4 = 1 + (6 + 3) + 11

+ 4 + 7 + 10 = (7 + 4 + 10 + 11 + 1) + (6 + 3) = sq.

HG + sq. HD.

\therefore sq. upon AB = sq. upon HB + sq. upon HA.

$\therefore h^2 = a^2 + b^2$. Q.E.D.

a. This figure and proof formulated by Joseph Zelson, see proof Sixty-Nine, a, fig. 169. It came to me on May 5, 1939.

b. In this proof, as in all proofs received I omitted the column of "reasons" for steps of the demonstration, and reduced the argumentation from many (in Zelson's proof over thirty) steps to a compact sequence of essentials, thus leaving, in all cases, the reader to recast the essentials in the form as given in our accepted modern texts.

By so doing a saving of as much as 60% of page space results--also hours of time for thinker and printer.



ISAAC NEWTON

1642-1727

One Hundred Sixteen

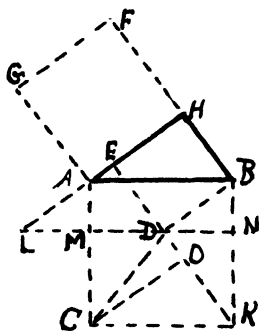


Fig. 216

In fig. 216, through D draw LN par. to AB, extend ED to K, and draw HL and CD.

Sq. AH = (rect. AN = paral. AD = sq. DH) + (rect. MK = 2 tri. DCK = sq. GH).

\therefore sq. upon AB = sq. upon BH + sq. upon AH. $\therefore h^2 = a^2 + b^2$.

a. Contrived by the author, August 1, 1900.

b. As in types A, B and C, many other proofs may be derived from the D type of figure.

E

This type includes all proofs derived from the figure in which the squares constructed upon the hypotenuse and the longer leg overlap the given triangle.

One Hundred Seventeen

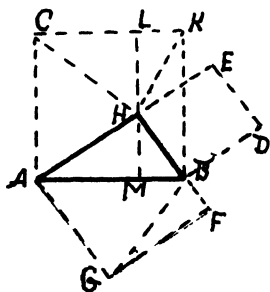


Fig. 217

In fig. 217, through H draw LM par. to KB, and draw GB, HK and HC.

Sq. AK = rect. LB + rect. LA = (2 tri. HBK = sq. HD) + (2 tri. CAH = 2 tri. BAG = sq. AF).

\therefore sq. upon AB = sq. upon BH + sq. upon AH. $\therefore h^2 = a^2 + b^2$.

a. See Jury Wipper, 1880, p. 14, VI; Edwards' Geom., 1895, p. 162, fig. (38); Am. Math. Mo., V. V, 1898, p. 74, proof LXXV; Versluys, p. 14, fig. 9, one of

Hoffmann's collection, 1818; Fourrey, p. 71, fig. g;
Math. Mo., 1859, Vol. II, No. 3, Dem. 13, fig. 5.

One Hundred Eighteen

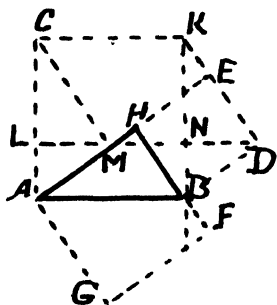


Fig. 218

In fig. 218, extend DE to K and draw DL and CM par. respectively to AB and BH.

Sq. AK = (rect. LB = paral. AD = sq. BE) + (rect. LK = paral. CD = trap. CMEK = trap. AGFB) + (tri. KDN = tri. CLM) = sq. BE + sq. AF.

\therefore sq. upon AB = sq. upon BH + sq. upon AH. $\therefore h^2 = a^2 + b^2$.

a. See Am. Math. Mo., V. V, 1898, p. 74, LXXIX.

One Hundred Nineteen

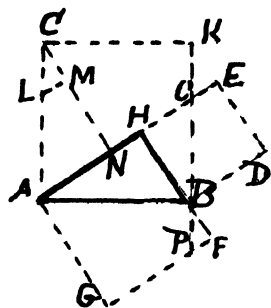


Fig. 219

In fig. 219, extend KB to P, draw CN par. to HB, take NM = HB, and draw ML par. to AH.

Sq. AK = (quad. NOKC = quad. GPBA) + (tri. CLM = tri. BPF) + (trap. ANML = trap. BDEO) + tri. ABH common to sq's AK and AF + tri. BOH common to sq's AK and HD = sq. HD + sq. AF.

\therefore sq. upon AB = sq. upon BH + sq. upon AH. $\therefore h^2 = a^2 + b^2$.

a. Am. Math. Mo., Vol. V, 1898, p. 74, proof LXXVII;

School Visitor, Vol. III, p. 208, No. 410.

One Hundred Twenty

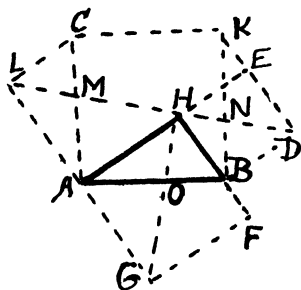


Fig. 220

In fig. 220, extend DE to K, GA to L, draw CL par. to AH, and draw LD and HG.

$$\begin{aligned} \text{Sq. AK} &= 2[\text{trap. ABNM} \\ &= \text{tri. AOH common to sq's AK} \\ &\text{and AF} + (\text{tri. AHM} = \text{tri. AGO}) \\ &+ \text{tri. HBN common to sq's AK} \\ &\text{and HD} + (\text{tri. BHO} = \text{tri. BDN})] \\ &= \text{sq. HD} + \text{sq. AF.} \end{aligned}$$

\therefore sq. upon AB = sq. upon BH + sq. upon AH.

a. See Am. Math. Mo., Vol. V, 1898, p. 74, proof LXXXVI.

One Hundred Twenty-One

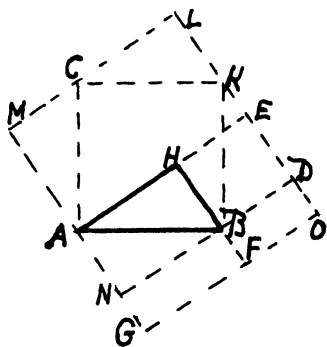


Fig. 221

Extend GF and ED to O, and complete the rect. MO, and extend DB to N.

$$\begin{aligned} \text{Sq. AK} &= \text{rect. MO} \\ &- (4 \text{ tri. ABH} + \text{rect. NO}) \\ &= \{(\text{rect. AL} + \text{rect. AO}) \\ &- (4 \text{ tri. AHB} + \text{rect. NO})\} \\ &= 2(\text{rect. AO} = \text{rect. AD} \\ &+ \text{rect. NO}) = (2 \text{ rect. AD} \\ &+ 2 \text{ rect. NO} - \text{rect. NO} \\ &- 4 \text{ tri. ABH}) - (2 \text{ rect. AD} \\ &+ \text{rect. NO} - 4 \text{ tri. ABH}) \\ &= (2 \text{ rect. AB} + 2 \text{ rect. HD} \\ &+ \text{rect. NF} + \text{rect. BO} - 4 \\ &\text{tri. ABH}) = [\text{rect. AB} \end{aligned}$$

$$\begin{aligned} &+ (\text{rect. AB} + \text{rect. NF}) + \text{rect. HD} + (\text{rect. HD} + \text{rect. BO}) - 4 \text{ tri. ABH} \\ &= 2 \text{ tri. ABH} + \text{sq. HG} + \text{sq. HD} \\ &+ 2 \text{ tri. ABH} - 4 \text{ tri. ABH} = \text{sq. HD} + \text{sq. HG.} \end{aligned}$$

\therefore sq. upon AB = sq. upon BH + sq. upon AH.

$$\therefore h^2 = a^2 + b^2.$$

a. This formula and conversion is that of the author, Dec. 22, 1933, but the figure is as given in Am. Math. Mo., Vol. V, 1898, p. 74, where see another somewhat different proof, No. LXXVIII. But same figure furnishes:

One Hundred Twenty-Two

In fig. 221, extend GF and ED to O and complete the rect. MO. Extend DB to N.

Sq. AK = rect. NO + 4 tri. ABH = rect. MO = sq. HD + sq. AF + rect. BO + [rect. AL = (rect. HN = 2 tri. ABH) + (sq. HG = 2 tri. ABH + rect. NF)], which coll'd gives sq. AK = sq. HD + sq. HG.

\therefore sq. upon AB = sq. upon BH + sq. upon AH.
 $\therefore h^2 = a^2 + b^2$.

a. Credited to Henry Boad by Joh. Hoffmann, in "Der Pythagoraische Lehrsatz," 1821; see Jury Wipper, 1880, p. 21, fig. 15.

One Hundred Twenty-Three

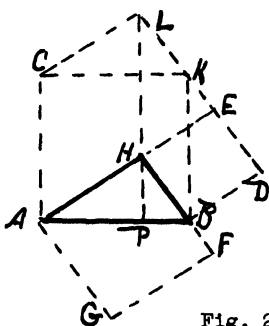


Fig. 222

In fig. 222, draw CL and KL par. respectively to AH and BH, and draw through H, LP.

Sq. AK = hexagon AHBKLC = paral. LB + paral. LA = sq. HD + sq. AF.

\therefore sq. upon AB = sq. upon BH + sq. upon AH. $\therefore h^2 = a^2 + b^2$.

a. Devised by the author, March 12, 1926.

One Hundred Twenty-Four

Rect. LM = [sq. AK = (parts 2 common to sq. AK and sq. HD + 3 + 4 + 5 common to sq. AK and sq. HG)

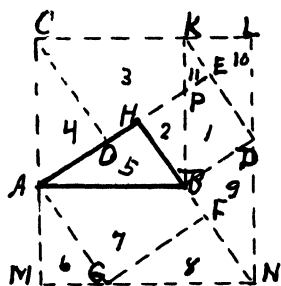


Fig. 223

+ parts 6 + (7 + 8 = sq. HG)
 + 9 + 1 + 10 + 11 = [sq. AK = sq.
 HG + parts {(6 = 2) + 1 = sq.
 HD} + parts (9 + 10 + 11 = 2 tri.
 ABN + tri. KPE)] = [(sq. AK = sq.
 HD + sq. HG) + (2 tri. ABH
 + tri. KPE)], or rect. LM - (2
 tri. ABH + tri. KPE) = [sq. AK
 = sq. HD + sq. HA].
 \therefore sq. AK = sq. HD + sq.
 HA. \therefore sq. upon AB = sq. upon
 HD + sq. upon HA. $\therefore h^2 = a^2$
 + b^2 . Q.E.D.

a. Original with the author, June 17, 1939.

b. See Am. Math. Mo., Vol. V, 1898, p. 74,
 proof LXXVIII for another proof, which is: (as per
 essentials):

One Hundred Twenty-Five

In fig. 223, extend CA, HB, DE and CK to M, N, K and L respectively, and draw MN, LN and CO respectively par. to AB, KB and HB.

Sq. AK + 2 tri. AGM + 3 tri. GNF + trap. AGFB = rect. CN = sq. HD + sq. HG + 2 tri. AGM + 3 tri. GNF + trap. COEK, which coll'd gives sq. AK = sq. HD + sq. HG.

\therefore sq. upon AB = sq. upon
 BH + sq. upon AH. $\therefore h^2 = a^2 + b^2$.

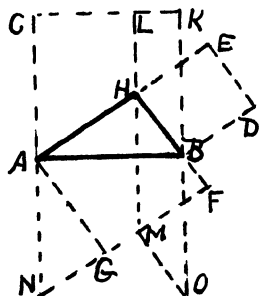


Fig. 224

One Hundred Twenty-Six

In fig. 224, extend KB and CA respectively to O and N, through H draw LM par. to KB, and draw GN and MO respectively par. to AH and BH.

Sq. AK = rect. LB + rect. LA = paral. BHMO + paral. HANM = sq. HD + sq. AF.

\therefore sq. upon AB = sq. upon BH + sq. upon AH.
 $\therefore h^2 = a^2 + b^2$.

a. Original with the author, August 1, 1900.

b. Many other proofs are derivable from this type of figure.

c. An algebraic proof is easily obtained from fig. 224.

F

This type includes all proofs derived from the figure in which the squares constructed upon the hypotenuse and the shorter leg overlap the given triangle.

One Hundred Twenty-Seven

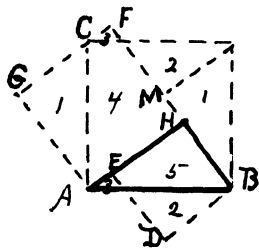


Fig. 225

In the fig. 225, draw KM par. to AH.

Sq. AK = (tri. BKM = tri. ACG) + (tri. KLM = tri. BND) + quad. AHLC common to sq's AK and AK + (tri. ANE = tri. CLF) + trap. NBHE common to sq's AK and EB = sq. HD + sq. HG.

\therefore sq. upon AB = sq. upon BH + sq. upon AH. $\therefore h^2 = a^2 + b^2$.

a. The Journal of Education, V. XXVIII, 1888, p. 17, 24th proof, credits this proof to J. M. McCready, of Black Hawk, Wis.; see Edwards' Geom., 1895, p. 89, art. 73; Heath's Math. Monographs, No. 2, 1900, p. 32, proof XIX; Scientific Review, Feb. 16, 1889, p. 31, fig. 30; R. A. Bell, July 1, 1938, one of his 40 proofs.

b. By numbering the dissected parts, an obvious proof is seen.

One Hundred Twenty-Eight

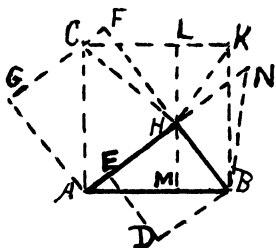


Fig. 226

In fig. 226, extend AH to N making $HN = HE$, through H draw LM par. to BK, and draw BN, HK and HC.

Sq. AK = rect. LB + rect. LA = (2 tri. HBK = 2 tri. HBN = sq. HD) + (2 tri. CAH = 2 tri. AHC = sq. HG) = sq. HD + sq. HG. \therefore sq. upon AB = sq. upon BH + sq. upon AH. $\therefore h^2 = a^2 + b^2$.

a. Original with the author, August 1, 1900.

b. An algebraic proof may be resolved from this figure.

c. Other geometric proofs are easily derived from this form of figure.

One Hundred Twenty-Nine

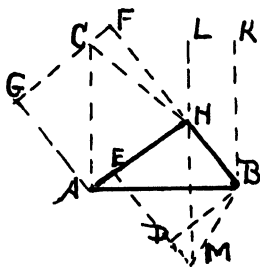


Fig. 227

In fig. 227, draw LH perp. to AB and extend it to meet ED produced and draw MB, HK and HC.

Sq. AK = rect. LB + rect. LA = (paral. HMBK = 2 tri. MBH = sq. BE) + (2 tri. CAH = 2 tri. AHC = sq. AF) = sq. BE + sq. AF. \therefore sq. upon AB = sq. upon BH + sq. upon AH. $\therefore h^2 = a^2 + b^2$.

a. See Jury Wipper, 1880, p. 14, fig. 7; Versluys, p. 14, fig. 10; Fourrey, p. 71, fig. f.

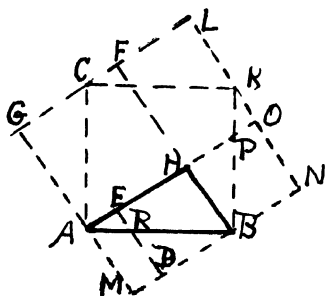
One Hundred Thirty

Fig. 228

In fig. 228, extend GA and BD to M, complete the square ML, and extend AH to O.

Sq. AK + 4 tri. ABH
 = sq. LM = sq. HD + sq. HG
 + 3 tri. ABH = (trap. BNOP
 + tri. ARE = tri. ABH), which
 collected gives sq. AK = sq.
 HD + sq. HG.

\therefore sq. upon AB = sq.
 upon BH + sq. upon AH. $\therefore h^2$
 = $a^2 + b^2$.

a. See Jury Wipper, 1880, p. 17, fig. 11, where it is credited, by Johann Hoffmann, in "Der Pythagoraische Lehrsatz," 1821, to Henry Boad.

G

This type includes all proofs derived from figures in which the squares constructed upon the two legs overlap the given triangle.

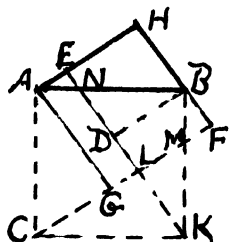
One Hundred Thirty-One

Fig. 229

In fig. 229, extend FG to C and draw KL par. to AG.

Sq. AK = quad. AGMB common
 to sq's AK and AF + (tri. ACG = tri.
 ABH) + (tri. CKL = trap. NBHE + tri.
 BMF) + (tri. KML = tri. BND) = sq.
 HD + sq. HG.

\therefore sq. upon AB = sq. upon BH
 + sq. upon AH. $\therefore h^2 = a^2 + b^2$.
 Q.E.D.

a. See Edwards' Geom., 1895, p. 161, fig. (33); Am. Math. Mo.,

V. V, 1898, p. 73, proof LXX; A. R. Bell, Feb. 24, 1938.

b. In Sci. Am. Sup., V. 70, p. 359, Dec. 3, 1910, is a proof by A. R. Colburn, by use of above figure, but the argument is not that given above.

One Hundred Thirty-Two

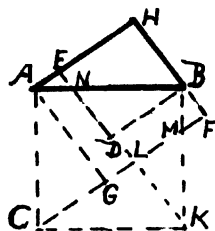


Fig. 230

In fig. 230, extend FG to C and ED to K.

Sq. AK = (tri. ACG = tri. ABH of sq. HG) + (tri. CKL = trap. NBHE + tri. BMF) + (tri. KBD = tri. BDN of sq. HD + trap. LMBD common to sq's AK and HG) + pentagon AGLDB common to sq's AK and HG) = sq. HD + sq. HG.

\therefore sq. upon AB = sq. upon BH + sq. upon AH. $\therefore h^2 = a^2 + b^2$.

a. See Edwards' Geom., 1895, p. 159, fig. (24); Sci. Am. Sup., V. 70, p. 382, Dec. 10, 1910, for a proof by A. R. Colburn on same form of figure.

One Hundred Thirty-Three

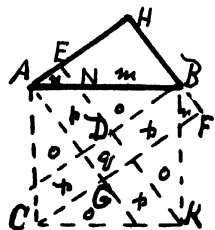


Fig. 231

The construction is obvious. Also that $m + n = o + p$; also that tri. ABH and tri. ACG are congruent. Then sq. AK = $4o + 4p + q = 2(o + p) + 2(o + p) + q = 2(m + n) + 2(o + p) + q = 2(m + o) + (m + 2n + o + 2p + q) = \text{sq. HD} + \text{sq. HA}$.

\therefore sq. upon AB = sq. upon HD + sq. upon HA. $\therefore h^2 = a^2 + b^2$. Q.E.D.

a. See Versluys, p. 48, fig. 49, where credited to R. Joan, Nepomucen Reichenberger, Philosophia et Mathesis Universa, Regensburg, 1774.

b. By using congruent tri's and trap's the algebraic appearance will vanish.

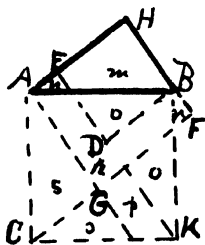
One Hundred Thirty-Four

Fig. 232

Having the construction, and the parts symbolized, it is evident that: $\text{sq. AK} = 3o + p + r + s = (3o + p) + (o + p = s) + r = 2(o + p) + 2o + r = (m + o) + (m + 2n + o + r) = \text{sq. HD} + \text{sq. HG}.$

$\therefore \text{sq. upon AB} = \text{sq. upon HD} + \text{sq. upon HA.} \therefore h^2 = a^2 + b^2.$

a. See Versluys, p. 48, fig. 50; Fourrey, p. 86.

b. By expressing the dimensions of m, n, o, p, r and s in terms of $a, b,$ and h an algebraic proof results.

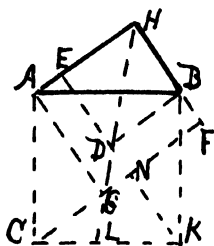
One Hundred Thirty-Five

Fig. 233

Complete the three sq's AK, HG and HD, draw CG, KN, and HL through G. Then

$\text{Sq. AK} = 2[\text{trap. ACLM} = \text{tri. GMA common to sq's AK and AF} + (\text{tri. ACG} = \text{tri. AMH of sq. AF} + \text{tri. HMB of sq. HD}) + (\text{tri. CLG} = \text{tri. BMD of sq. HD})] = \text{sq. HD} + \text{sq. HG.} \therefore h^2 = a^2 + b^2.$

$\therefore \text{sq. upon AB} = \text{sq. upon BH} + \text{sq. upon AH}.$

a. See Am. Math. Mo., V. V, 1898, p. 73, proof LXXII.

One Hundred Thirty-Six

Draw CL and LK par. respectively to HB and HA, and draw HL.

$\text{Sq. AK} = \text{hexagon ACLKBH} - 2 \text{ tri. ABH} = 2 \text{ quad. ACLH} - 2 \text{ tri. ABH} = 2 \text{ tri. ACG} + (2 \text{ tri. CLG} = \text{sq. HD})$

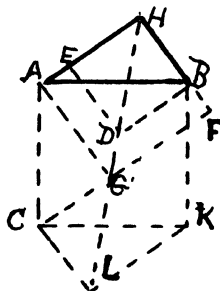


Fig. 234

$+ (2 \text{ tri. AGH} = \text{sq. HG}) - 2 \text{ tri. ABH}$
 $= \text{sq. HD} + \text{sq. HG} + (2 \text{ tri. ACG} = 2$
 $\text{tri. ABH} - 2 \text{ tri. ABH} = \text{sq. HD} - \text{sq.}$
 $\text{HG}.$

$\therefore \text{sq. upon AB} = \text{sq. upon HD}$
 $+ \text{sq. upon HA.} \therefore h^2 = a^2 + b^2.$
 Q.E.D.

a. Original by author Oct.
 25, 1933.

One Hundred Thirty-Seven

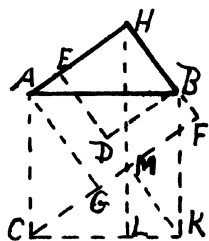


Fig. 235

In fig. 235, extend FG to C,
 ED to K and draw HL par. to BK.

$\text{Sq. AK} = \text{rect. BL} + \text{rect. AL}$
 $= (\text{paral. MKBH} = \text{sq. HD}) + (\text{paral.}$
 $\text{CMHA} = \text{sq. HG}) = \text{sq. HD} + \text{sq. HG}.$

$\therefore \text{sq. upon AB} = \text{sq. upon BH}$
 $+ \text{sq. upon AH.} \therefore h^2 = a^2 + b^2.$
 Q.E.D.

a. Journal of Education, V.
 XXVII, 1888, p. 327, fifteenth proof
 by M. Dickinson, Winchester, N.H.;
 Edwards' Geom., 1895, p. 158, fig.

(22); Am. Math. Mo., V. V, 1898, p. 73, proof LXXI;
 Heath's Math. Monographs, No. 2, p. 28, proof XIV;
 Versluys, p. 13, fig. 8--also p. 20, fig. 17, for
 same figure, but a somewhat different proof, a proof
 credited to Jacob Gelder, 1810; Math. Mo., 1859, Vol.
 II, No. 2, Dem. 11; Fourrey, p. 70, fig. d.

b. An algebraic proof is easily devised from
 this figure.

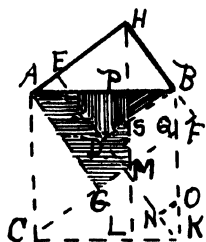
One Hundred Thirty-Eight

Fig. 236

Draw HL perp. to CK and extend ED and FG to K and C resp'ly.

$$\begin{aligned} \text{Sq. AK} &= \text{rect. BL} + \text{rect. AL} \\ &= (\text{tri. MLK} = \text{quad. RDSP} + \text{tri. PSB}) \\ &+ [\text{tri. BDK} - (\text{tri. SDM} = \text{tri. ONR}) \\ &= (\text{tri. BHA} - \text{tri. REA}) = \text{quad. RBHE}] \\ &+ [(\text{tri. CKM} = \text{tri. ABH}) + (\text{tri. CGA} \\ &= \text{tri. MFA}) + \text{quad. GMPA}] = \text{tri. RBD} \\ &+ \text{quad. RBHE} + \text{tri. APH} + \text{tri. MEH} \\ &+ \text{quad. GMPA} = \text{sq. HD} + \text{sq. HG}. \end{aligned}$$

$$\therefore \text{sq. upon AB} = \text{sq. upon BH} + \text{sq. upon AH.} \quad \therefore h^2 = a^2 + b^2. \quad \text{Q.E.D.}$$

a. See Versluys, p. 46, fig's 47 and 48, as given by M. Rogot, and made known by E. Fourrey in his "Curiosities of Geometry," on p. 90.

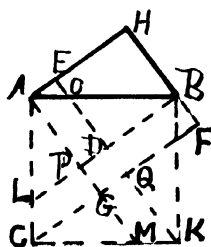
One Hundred Thirty-Nine

Fig. 237

In fig. 237, extend AG, ED, BD and FG to M, K, L and C respectively.

$$\begin{aligned} \text{Sq. AK} &= 4 \text{ tri. ALP} + 4 \text{ quad. LCGP} \\ &+ \text{sq. PQ} + \text{tri. AOE} - (\text{tri. BNE} = \text{tri. AOE}) \\ &= (2 \text{ tri. ALP} + 3 \text{ quad. LCGP} + \text{sq. PQ} \\ &+ \text{tri. AOE} = \text{sq. HG}) \\ &+ (2 \text{ tri. ALP} + \text{quad. LCGP} - \text{tri. AOE} = \text{sq. HD}) \\ &= \text{sq. HD} + \text{sq. HG}. \end{aligned}$$

$$\therefore \text{sq. upon AB} = \text{sq. upon BH} + \text{sq. upon AH.} \quad \therefore h^2 = a^2 + b^2.$$

a. See Jury Wipper, 1880, p. 29, fig. 26, as given by Reichenberger, in *Philosophia et Mathesis Universa*, etc., "Ratisbonae, 1774; Versluys, p. 48, fig. 49; Fourrey, p. 86.

b. Mr. Richard A. Bell, of Cleveland, O., submitted, Feb. 28, 1938, 6 fig's and proofs of the type G, all found between Nov. 1920 and Feb. 28, 1938. Some of his figures are very simple.

One Hundred Forty

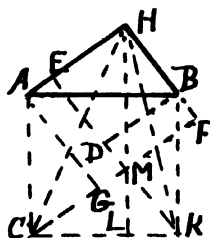


Fig. 238

In fig. 238, extend ED and FG to K and C respectively, draw HL perp. to CK, and draw HC and HK.

$$\begin{aligned} \text{Sq. AK} &= \text{rect. BL} + \text{rect. AL} \\ &= (\text{paral. MKBH} = 2 \text{ tri. KBH} = \text{sq. HD}) \\ &+ (\text{paral. CMHA} = 2 \text{ tri. CHA} = \text{sq. HG}) \\ &= \text{sq. HD} + \text{sq. HG}. \end{aligned}$$

$$\therefore \text{sq. upon AB} = \text{sq. upon BH} + \text{sq. upon AH.} \quad \therefore h^2 = a^2 + b^2.$$

a. See Jury Wipper, 1880, p. 12, fig. 4.

b. This proof is only a variation of the one preceding.

c. From this figure an algebraic proof is obtainable.

One Hundred Forty-One

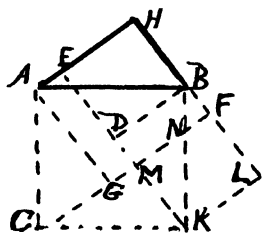


Fig. 239

In fig. 239, extend FG to C, HF to L making FL = HB, and draw KL and KM respectively par. to AH and BH.

$$\begin{aligned} \text{Sq. AK} &= \{[(\text{tri. CKM} \\ &= \text{tri. BKL}) - \text{tri. BNF} = \text{trap.} \\ &\text{OBHE}] + (\text{tri. KMN} = \text{tri. BOD}) \\ &= \text{sq. HD}\} + [(\text{tri. ACG} = \text{tri. ABH}) \\ &+ (\text{tri. BOD} + \text{hexagon AGNBDO}) \\ &= \text{sq. HG}] = \text{sq. HD} + \text{sq. HG}. \end{aligned}$$

$$\therefore \text{sq. upon AB} = \text{sq. upon BH} + \text{sq. upon AH.} \quad \therefore h^2 = a^2 + b^2.$$

a. As taken from "Philosophia et Mathesis Universa, etc.," Ratisbonae, 1774, by Reichenberger; see Jury Wipper, 1880, p. 29, fig. 27.

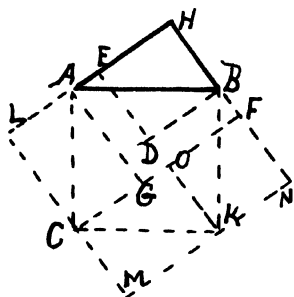
One Hundred Forty-Two

Fig. 240

In fig. 240, extend HF and HA respectively to N and L, and complete the sq. HM, and extend ED to K and BG to C.

Sq. AK = sq. HM - 4 tri. ABH = (sq. FK = sq. HD) + sq. HG + (rect. LG = 2 tri. ABH) + (rect. OM = 2 tri. ABH) = sq. HD + sq. HG + 4 tri. ABH - 4 tri. ABH = sq. HD + sq. HG.

\therefore sq. upon AK = sq. upon BH + sq. upon AH.
 $\therefore h^2 = a^2 + b^2$.

a. Similar to Henry Boad's proof, London, 1733; see Jury Wipper, 1880, p. 16, fig. 9; Am. Math. Mo., V. V, 1898, p. 74, proof LXXIV.

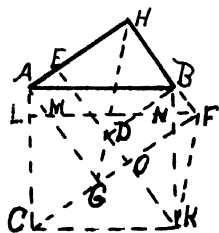
One Hundred Forty-Three

Fig. 241

In fig. 241, extend FG and ED to C and K respectively, draw FL par. to AB, and draw HD and FK.

Sq. AK = (rect. AN = paral. MB) + (rect. LK = 2 tri. CKF = 2 tri. CKO + 2 tri. FOK = tri. FMG + tri. ABH + 2 tri. DBH) = sq. HD + sq. HG.

\therefore sq. upon AB = sq. upon BH + sq. upon AH. $\therefore h^2 = a^2 + b^2$.
 Q.E.D.

a. See Am. Math. Mo., Vol. V, 1898, p. 74, proof LXXIII.

One Hundred Forty-Four

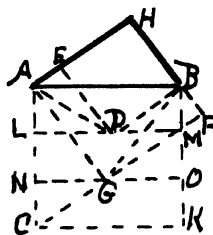


Fig. 242

In fig. 242, produce FG to C, through D and G draw LM and NO par. to AB, and draw AD and BG.

$$\begin{aligned} \text{Sq. AK} &= \text{rect. NK} + \text{rect. AO} \\ &= (\text{rect. AM} = 2 \text{ tri. ADB} = \text{sq. HD}) \\ &+ (2 \text{ tri. GBA} = \text{sq. HG}) = \text{sq. HD} \\ &+ \text{sq. HG.} \end{aligned}$$

$$\begin{aligned} \therefore \text{sq. upon AB} &= \text{sq. upon BH} \\ &+ \text{sq. upon AH.} \quad \therefore h^2 = a^2 + b^2. \end{aligned}$$

a. This is No. 15 of A. R. Colburn's 108 proofs; see his proof in Sci. Am. Sup., V. 70, p. 383,

Dec. 10, 1910.

b. An algebraic proof from this figure is easily obtained.

$$2 \text{ tri. BAD} = hx = a^2. \quad \text{--- (1)}$$

$$2 \text{ tri. BAG} = h(h - x) = b^2. \quad \text{--- (2)}$$

$$(1) + (2) = (3) h^2 = a^2 + b^2. \quad (\text{E.S.L.})$$

One Hundred Forty-Five

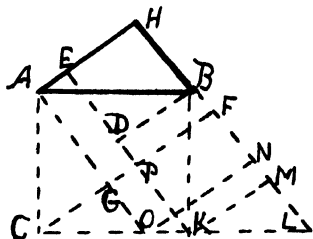


Fig. 243

In fig. 243, produce HF and CK to L, ED to K, and AG to O, and draw KM and ON par. to AH.

$$\begin{aligned} \text{Sq. AK} &= \text{paral. AOLB} \\ &= [\text{trap. AGFB} + (\text{tri. OLM} \\ &= \text{tri. ABH}) = \text{sq. HG}] + \{\text{rect.} \\ &\text{GN} = \text{tri. CLF} - (\text{tri. COG} \\ &= \text{tri. KLM}) - (\text{tri. OLN} \\ &= \text{tri. CKP})\} = \text{sq. FK} = \text{sq.} \\ &\text{HD} \} = \text{sq. HD} + \text{sq. HG.} \end{aligned}$$

$$\therefore \text{sq. upon AB} = \text{sq. upon BH} + \text{sq. upon AH.} \quad \therefore h^2 = a^2 + b^2.$$

a. This proof is due to Prin. Geo. M. Phillips, Ph.D., of the West Chester State Normal School, Pa., 1875; see Heath's Math. Monographs, No. 2, p. 36, proof XXV.

One Hundred Forty-Six

In fig. 244, extend CK and HF to M, ED to K, and AG to O making $GO = HB$, draw ON par. to AH , and draw GN .

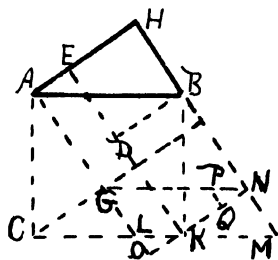


Fig. 244

Sq. $AK = \text{paral. } ALMB = \text{paral. } GM + \text{paral. } AN = [(\text{tri. } NGO - \text{tri. } NPO = \text{trap. } RBHE) + (\text{tri. } KMN = \text{tri. } BRD)] = \text{sq. } HD + \text{sq. } HG.$

$\therefore \text{sq. upon } AB = \text{sq. upon } BH + \text{sq. upon } AH. \therefore h^2 = a^2 + b^2.$

a. Devised by the author, March 14, 1926.

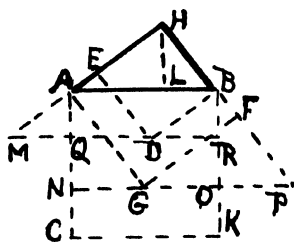
One Hundred Forty-Seven

Fig. 245

Through D draw DR par. AB meeting HA at M , and through G draw NO par. to AB meeting HB at P , and draw HL perp. to AB .

Sq. $AK = (\text{rect. } NK = \text{rect. } AR = \text{paral. } AMDB = \text{sq. } HB) + (\text{rect. } AO = \text{paral. } AGPB = \text{sq. } HG) = \text{sq. } HD + \text{sq. } HG.$

$\therefore \text{sq. upon } AB = \text{sq. upon } HB + \text{sq. upon } HA. \therefore h^2 = a^2 + b^2.$

a. See Versluys, p. 28, fig. 25. By Werner.

One Hundred Forty-Eight

Produce HA and HB to O and N resp'ly making $AO = HB$ and $BM = HA$, and complete the sq. HL .

Sq. $AK = \text{sq. } HL - (4 \text{ tri. } ABH = 2 \text{ rect. } OG) = [(\text{sq. } GL = \text{sq. } HD) + \text{sq. } HG + 2 \text{ rect. } OG] - 2 \text{ rect. } OG = \text{sq. } HD + \text{sq. } HG. \therefore \text{sq. upon } AB = \text{sq. upon } BH + \text{sq. upon } AH. \therefore h^2 = a^2 + b^2.$

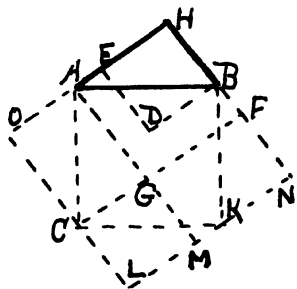


Fig. 246

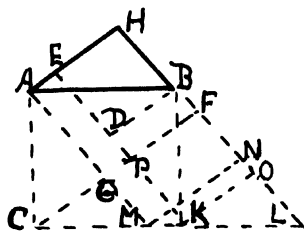


Fig. 247

a. See Versluys, p. 52, fig. 54, as found in Hoffmann's list and in "Des Pythagoraische Lehrsatz," 1821.

One Hundred Forty-Nine

Produce CK and HB to L, AG to M, ED to K, FG to C, and draw MN and KO par. to AH.

Sq. AK = paral. AMLB = quad. AGFB + rect. GN + (tri. MLN = tri. ABH) = sq. GH + (rect. GN = sq. PO = sq. HD) = sq. HG + sq. HD. \therefore sq. upon AB = sq. upon HB + sq. upon HA. $\therefore h^2 = a^2 + b^2$.

a. By Dr. Geo. M. Phillips, of West Chester, Pa., in 1875; Versluys, p. 58, fig. 62.

H

This type includes all proofs devised from the figure in which the squares constructed upon the hypotenuse and the two legs overlap the given triangle.

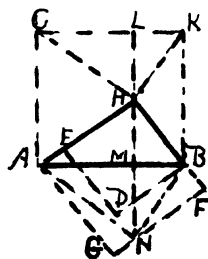


Fig. 248

One Hundred Fifty

Draw through H, LN perp. to AB, and draw HK, HC, NB and NA.

Sq. AK = rect. LB + rect. LA = paral. KN + paral. CN = 2 tri. KHB + 2 tri. NHA = sq. HD + sq. HG. \therefore sq. upon AB = sq. upon HD + sq. upon HA. $\therefore h^2 = a^2 + b^2$. Q.E.D.

a. See Math. Mo., 1859, Vol. II, No. 2, Dem. 15, fig. 7.

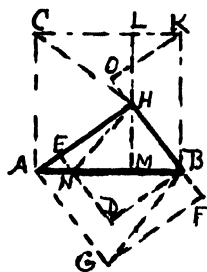
One Hundred Fifty-One

Fig. 249

1898, p. 78, proof LXXXI; also see Fourrey, p. 71, fig. h, in his "Curiosities."

b. This figure gives readily an algebraic proof.

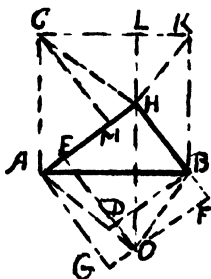
One Hundred Fifty-Two

Fig. 250

In fig. 250, extend ED to O, draw AO, OB, HK and HC, and draw, through H, LO perp. to AB, and draw CM perp. to AH.

Sq. AK = rect. LB + rect. LA
 = (paral. HOBK = 2 tri. OBH = sq. HD) + (paral. CAOH = 2 tri. OHA = sq. HG) = sq. HD + sq. HG.
 \therefore sq. upon AB = sq. upon BH + sq. upon AH. $\therefore h^2 = a^2 + b^2$.
 Q.E.D.

a. See Olney's Geom., 1872, Part III, p. 251, 6th method; Journal of Education, V. XXVI, 1887, p. 21, fig. XIII; Hopkins' Geom., 1896, p. 91, fig. VI; Edw. Geom., 1895, p. 160, fig. (31); Am. Math. Mo., 1898, Vol. V, p. 74, proof LXXX; Heath's Math. Monographs, No. 1, 1900, p. 26, proof XI.

b. From this figure deduce an algebraic proof.

One Hundred Fifty-Three

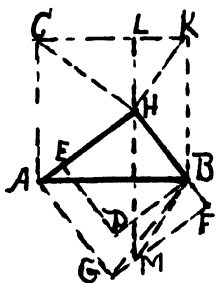


Fig. 251

In fig. 251, draw LM perp. to AB through H, extend ED to M, and draw BG, BM, HK and HC.

$$\begin{aligned} \text{Sq. AK} &= \text{rect. LB} + \text{rect. LA} \\ &= (\text{paral. KHMB} = 2 \text{ tri. MBH} = \text{sq. HD}) \\ &+ (2 \text{ tri. AHC} = 2 \text{ tri. AGB} = \text{sq. HG}) \\ &= \text{sq. HD} + \text{sq. HG}. \end{aligned}$$

$$\therefore \text{sq. upon AB} = \text{sq. upon BH} + \text{sq. upon AH.} \quad \therefore h^2 = a^2 + b^2.$$

a. See Jury Wipper, 1880, p. 15, fig. 8; Versluys, p. 15, fig. 11.

b. An algebraic proof follows the "mean prop'l" principle.

One Hundred Fifty-Four

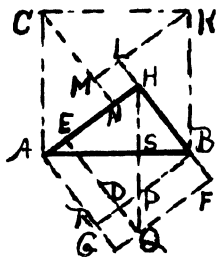


Fig. 252

In fig. 252, extend ED to Q, BD to R, draw HQ perp. to AB, CN perp. to AH, KM perp. to CN and extend BH to L.

$$\begin{aligned} \text{Sq. AK} &= \text{tri. ABH common to} \\ &\text{sq's AK and HG} + (\text{tri. BKL} = \text{trap.} \\ &\text{HEDP of sq. HD} + \text{tri. QPD of sq. HG}) \\ &+ (\text{tri. KCM} = \text{tri. BAR of sq. HG}) \\ &+ (\text{tri. CAN} = \text{trap. QFBP of sq. HG} \\ &+ \text{tri. PBH of sq. HD}) + (\text{sq. MN} = \text{sq.} \\ &\text{RQ}) = \text{sq. HD} + \text{sq. HG}. \end{aligned}$$

$$\therefore \text{sq. upon AB} = \text{sq. upon BH} + \text{sq. upon AH.} \quad \therefore h^2 = a^2 + b^2.$$

a. See Edwards' Geom., 1895, p. 157, fig. (13); Am. Math. Mo., V. V, 1898, p. 74, proof LXXXII.

One Hundred Fifty-Five

In fig. 253, extend ED to P, draw HP, draw CM perp. to AH, and KL perp. to CM.

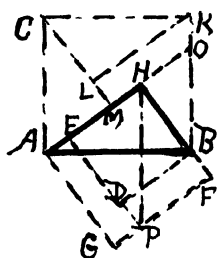


Fig. 253

Sq. AK = tri. ANE common to sq's AK and NG + trap. ENBH common to sq's AK and HD + (tri. BOH = tri. BND of sq. HD) + (trap. KLMO = trap. AGPN) + (tri. KCL = tri. PHE of sq. HG) + (tri. CAM = tri. HPF of sq. HG) = sq. HD + sq. HG.

\therefore sq. upon AB = sq. upon BH + sq. upon AH. $\therefore h^2 = a^2 + b^2$.

a. Original with the author, August 3, 1890.

b. Many other proofs may be devised from this type of figure.

One Hundred Fifty-Six

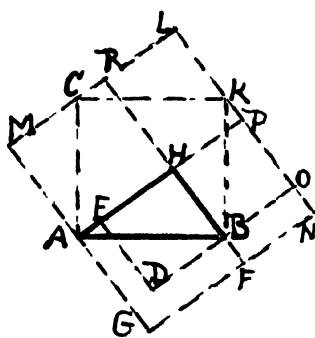


Fig. 254

In fig. 254, extend GA to M making AM = AG, GF to N making FN = BH, complete the rect. MN, and extend AH and DB to P and O resp'ly and BH to R.

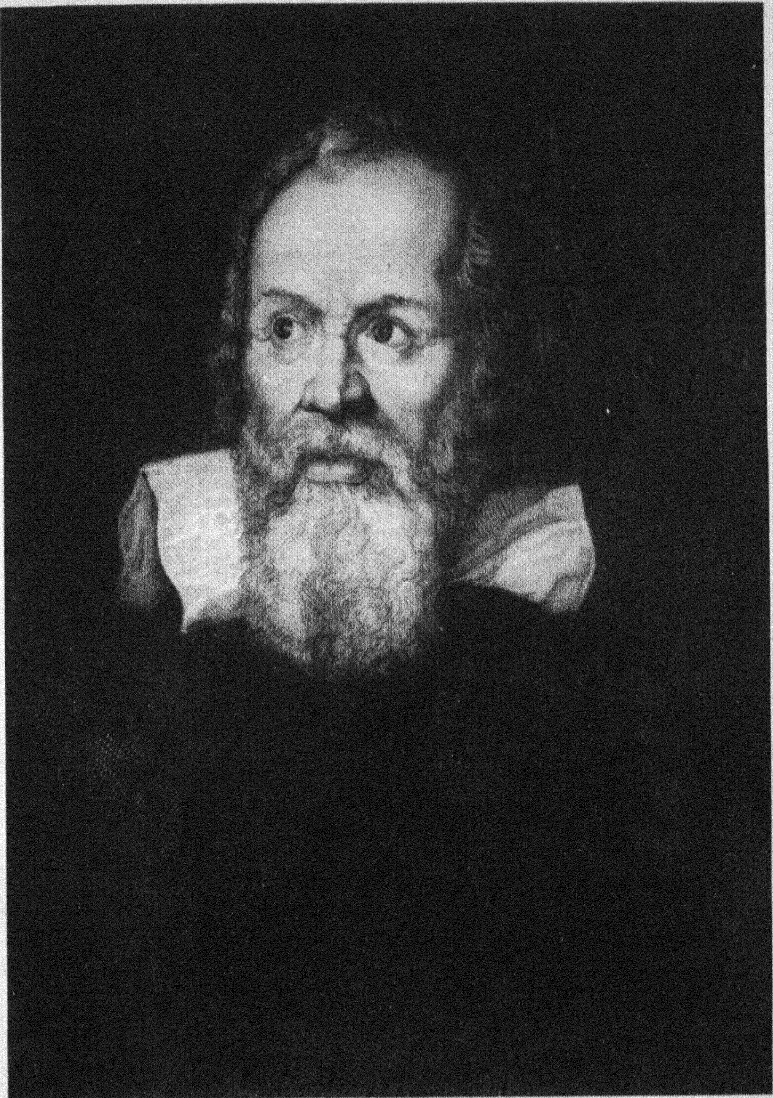
Sq. AK = rect. MN
 - (rect. BN + 3 tri. ABH + trap. AGFB) = (sq. HD = sq. DH) + sq. HG + rect. BN + [rect. AL = (rect. HL = 2 tri. ABH) + (sq. AP = tri. ABH + trap. AGFB)] = sq. HD + sq. HG + rect. BN + 2 tri. ABH + tri. ABH + trap. AGFB - rect.

BN - 3 tri. ABH - trap. AGFB = sq. HD + sq. HG.

\therefore sq. upon AB = sq. upon BH + sq. upon AH.

$\therefore h^2 = a^2 + b^2$. Q.E.D.

a. See Jury Wipper, 1880, p. 22, fig. 16, credited by Joh. Hoffmann in "Der Pythagoraische Lehrsatz," 1821, to Henry Boad, of London, England.



GALILEO GALILEI

1564-1642

One Hundred Fifty-Seven

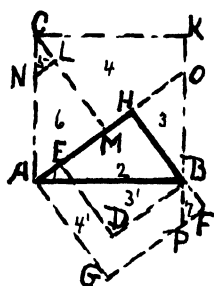


Fig. 255

In fig. 255 we have sq. AK = parts 1 + 2 + 3 + 4 + 5 + 6; sq. HD = parts 2 + 3'; sq. HG = parts 1 + 4' + (7 = 5) + (6 = 2); so sq. AK(1 + 2 + 3 + 4 + 5 + 6) = sq. HD[2 + (3' = 3)] + sq. HG[1 + (4' = 4) + (7 = 5) + (2 = 6)].

∴ sq. upon AB = sq. upon HD + sq. upon HA. ∴ $h^2 = a^2 + b^2$. Q.E.D.

a. Richard A. Bell, of Cleveland, O., devised above proof, Nov. 30, 1920 and gave it to me Feb. 28, 1938. He has 2 others, among his

40, like unto it.

I

This type includes all proofs derived from a figure in which there has been a translation from its normal position of one or more of the constructed squares.

Symbolizing the hypotenuse-square by h , the shorter-leg-square by a , and the longer-leg-square by b , we find, by inspection, that there are *seven* distinct cases possible in this I-type figure, and that each of the first three cases have *four* possible arrangements, each of the second three cases have *two* possible arrangements, and the seventh case has but one arrangement, thus giving 19 sub-types, as follows:

- (1) Translation of the h -square, with
 - (a) The a - and b -squares constructed outwardly.
 - (b) The a -sq. const'd out'ly and the b -sq. overlapping.
 - (c) The b -sq. const'd out'ly and the a -sq. overlapping.
 - (d) The a - and b -sq's const'd overlapping.

- (2) Translation of the a-square, with
 - (a) The h- and b-sq's const'd out'ly.
 - (b) The h-sq. const'd out'ly and the b-sq. overlapping.
 - (c) The b-sq. const'd out'ly and the h-sq. overlapping.
 - (d) The h- and b-sq's const'd overlapping.
- (3) Translation of the b-square, with
 - (a) The h- and a-sq's const'd out'ly.
 - (b) The h-sq. const'd out'ly and the a-sq. overlapping.
 - (c) The a-sq. const'd out'ly and the h-sq. overlapping.
 - (d) The h- and a-sq's const'd overlapping.
- (4) Translation of the h- and a-sq's, with
 - (a) The b-sq. const'd out'ly.
 - (b) The b-sq. overlapping.
- (5) Translation of the h- and b-sq's with
 - (a) The a-sq. const'd out'ly.
 - (b) The a-sq. const'd overlapping.
- (6) Translation of the a- and b-sq's, with
 - (a) The h-sq. const'd out'ly.
 - (b) The h-sq. const'd overlapping.
- (7) Translation of all three, h-, a- and b-squares.

From the sources of proofs consulted, I discovered that only 8 out of the possible 19 cases had received consideration. To complete the gap of the 11 missing ones I have devised a proof for each missing case, as by the Law of Dissection (see fig. 111, proof Ten) a proof is readily produced for any position of the squares. Like Agassiz's student, after proper observation he found the law, and then the arrangement of parts (scales) produced desired results.

One Hundred Fifty-Eight

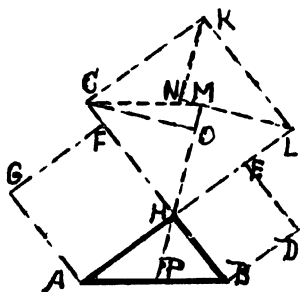


Fig. 256

Case (1), (a).

In fig. 256, the sq. upon the hypotenuse, hereafter called the h-sq. has been translated to the position HK. From P the middle pt. of AB draw PM making $HM = AH$; draw LM, KM, and CM; draw $KN = LM$, perp. to LM produced, and $CO = AB$, perp. to HM.

$$\begin{aligned} \text{Sq. HK} &= (2 \text{ tri. HMC} \\ &= HM \times CO = \text{sq. AH}) + (2 \text{ tri.} \\ &\text{MLK} = ML \times KN = \text{sq. BH}) = \text{sq.} \end{aligned}$$

BH + sq. AH.

\therefore sq. upon AB = sq. upon BH + sq. upon AH.

$$\therefore h^2 = a^2 + b^2.$$

a. Original with the author, August 4, 1900.

Several other proofs from this figure is possible.

One Hundred Fifty-Nine

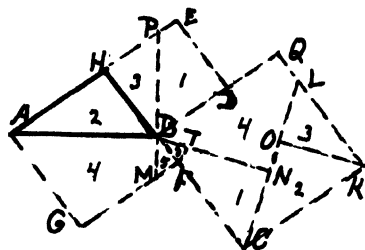


Fig. 257

Case (1), (b).

In fig. 257, the position of the sq's are evident, as the b-sq. overlaps and the h-sq. is translated to right of normal position. Draw PM perp. to AB through B, take $KL = PB$, draw LC, and BN and KO perp. to LC, and FT perp. to BN.

$$\text{Sq. BK} = (\text{trap.}$$

$$\begin{aligned} \text{FCNT} &= \text{trap. PBDE}) + (\text{tri. CKO} = \text{tri. ABH}) + (\text{tri.} \\ \text{KLO} &= \text{tri. BPH}) + (\text{quad. BOLQ} + \text{tri. BTF} = \text{trap. GFBA}) \\ &= \text{sq. BH} + \text{sq. AH.} \end{aligned}$$

\therefore sq. upon AB = sq. upon BH + sq. upon AH.

$$\therefore h^2 = a^2 + b^2.$$

a. One of my dissection devices.

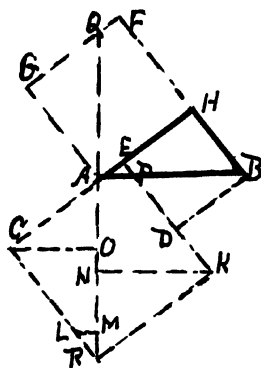
One Hundred Sixty

Fig. 258

Case (1), (c).

In fig. 258, draw RA and produce it to Q, and draw CO, LM and KN each perp. to RA.

Sq. CK = (tri. COA = tri. PDB) + (trap. CLMO + trap. PBHE) + (tri. NRK = tri. AQQ) + (quad. NKPA + tri. RML = trap. AHFQ) = sq. HB + sq. CK.

\therefore sq. upon AB = sq. upon BH + sq. upon AH. $\therefore h^2 = a^2 + b^2$.

a. Devised, by author, to cover Case (1), (c).

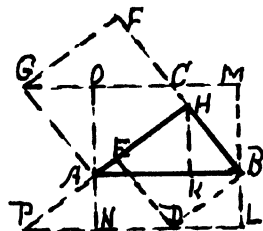
One Hundred Sixty-One

Fig. 259

Produce HA to P making AP = HB, draw PN par. to AB, and through A draw ON perp. to and = to AB, complete sq. OL, produce MO to G and draw HK perp. to AB.

Sq. OL = (rect. AL = paral. PDBA = sq. HD) + (rect. AM = paral. ABCG = sq. HG = sq. HB + sq. HG).

\therefore sq. upon AB = sq. upon HD + sq. upon HA. $\therefore h^2 = a^2 + b^2$. Q.E.D.

a. See Versluys, p. 27, fig. 23, as found in "Friend of Wisdom," 1887, as given by J. de Gelder, 1810, in Geom. of Van Kunze, 1842.

One Hundred Sixty-Two

Case (1), (d).

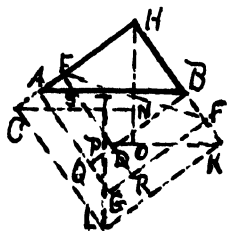


Fig. 260

Draw HO perp. to AB and equal to HA, and KP par. to AB and equal to HB; draw CN par. to AB, PL, EF, and extend ED to R and BD to Q.

Sq. CK = (tri. LKP = trap. ESBH of sq. HD + tri. ASE of sq. HG) + (tri. HOB = tri. SDB of sq. HD + trap. AQDS of sq. HG) + (tri. CNH = tri. FHE of sq. HG) + (tri. CLT

= tri. FER of sq. HG) + sq. TO = sq. DG of sq. HG = sq. HD + sq. HG.

\therefore sq. upon AB = sq. upon BH + sq. upon AH.

$\therefore h^2 = a^2 + b^2$. Q.E.D.

a. Conceived, by author, to cover case (1),

(d).

One Hundred Sixty-Three

Case (2), (a).

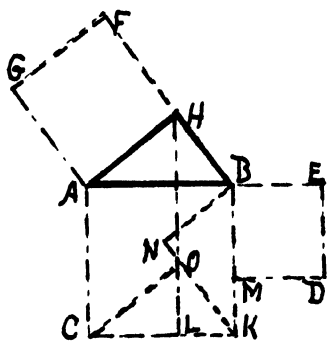


Fig. 261

In fig. 261, with sq's placed as in the figure, draw HL perp. to CK, CO and BN par. to AH, making BN = BH, and draw KN.

Sq. AK = rect. BL + rect. AL = (paral. OKBH = sq. BD) + (paral. COHA = sq. AF) = sq. BD + sq. HG.

\therefore sq. upon AB = sq. upon BH + sq. upon AH. $\therefore h^2 = a^2 + b^2$.

a. Devised, by author, to cover Case (2), (a).

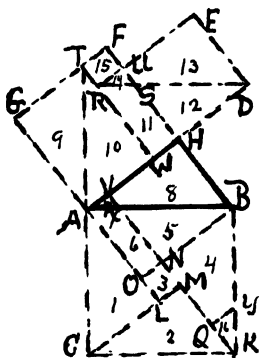
One Hundred Sixty-Four

Fig. 262

In fig. 262, the sq. AK
 = parts 1 + 2 + 3 + 4 + 5 + 6
 + 16. Sq. HD = parts (12 = 5)
 + (13 = 4) of sq. AK. Sq. HG
 = parts (9 = 1) + (10 = 2) + (11
 = 6) + (14 = 16) + (15 = 3) of
 sq. AK.
 \therefore sq. upon AB = sq. upon
 HD + sq. upon HA. $\therefore h^2 = a^2 + b^2$.
 Q.E.D.

a. This dissection and
 proof is that of Richard A. Bell,
 devised by him July 13, 1914, and
 given to me Feb. 28. 1938.

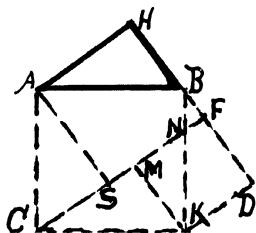
One Hundred Sixty-Five

Fig. 263

Case (2), (b).--For which are
 more proofs extant than for
 any other of these 19 cases--
 Why? Because of the obvious
 dissection of the resulting
 figures.

In fig. 263, extend FG to
 C. Sq. AK = (pentagon AGMKB
 = quad. AGNB common to sq's AK
 and AF + tri. KNM common to sq's
 AK and FK) + (tri. ACG = tri. BNF
 + trap. NKDF) + (tri. CKM = tri. ABH) = sq. FK + sq.
 AF.

\therefore sq. upon AB = sq. upon BH + sq. upon AH.
 $\therefore h^2 = a^2 + b^2$.

a. See Hill's Geom. for Beginners, 1886, p.
 154, proof I; Beman and Smith's New Plane and Solid
 Geom., 1899, p. 104, fig. 4; Versluys, p. 22, fig. 20,
 as given by Schlömilch, 1849; also F. C. Boon, proof
 7, p. 105; also Dr. Leitzmann, p. 18, fig. 20; also

Joseph Zelson, a 17 year-old boy in West Phila., Pa., High School, 1937.

b. This figure is of special interest as the sq. MD may occupy 15 other positions having common vertex with sq. AK and its sides coincident with side or sides produced of sq. HG. One such solution is that of fig. 256.

One Hundred Sixty-Six

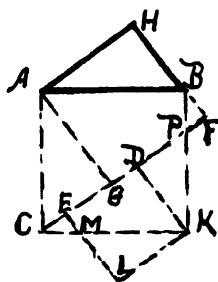


Fig. 264

In fig. 264, extend FG to C. Sq. AK = quad. AGPB common to sq's AK and AF + (tri. ACG = tri. ABH) + (tri. CME = tri. BPF) + (trap. EMKD common to sq's AK and EK) + (tri. KPD = tri. MLK) = sq. DL + sq. AF.

\therefore sq. upon AB = sq. upon BH + sq. upon AH. $\therefore h^2 = a^2 + b^2$.

a. See Edwards' *Geom.*, 1895, p. 161, fig. (35); Dr. Leitzmann, p. 18, fig. 21. 4th Edition.

One Hundred Sixty-Seven

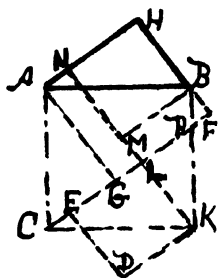


Fig. 265

In fig. 265, extend FG to C and const. sq. HM = sq. LD, the sq. translated.

Sq. AK = (tri. ACG = tri. ABH) + (tri. COE = tri. BPF) + (trap. EOKL common to both sq's AK and LD, or = trap. NQBH) + (tri. KPL = tri. KOD = tri. BQM) + [(tri. BQM + polygon AGPBMQ) = quad. AGPB common to sq's AK and AF] = sq. LD + sq. AF.

\therefore sq. upon AB = sq. upon BH + sq. upon AH. $\therefore h^2 = a^2 + b^2$.

a. See *Sci. Am. Sup.*, V. 70, p. 359, Dec. 3, 1910, by A. R. Colburn.

b. I think it better to omit Colburn's sq. HM (not necessary), and thus reduce it to proof above.

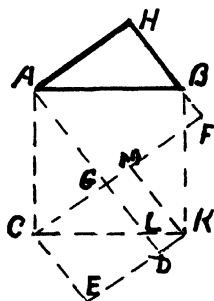
One Hundred Sixty-Eight

Fig. 266

In fig. 266, extend ED to K and draw KM par. to BH.

Sq. AK = quad. AGNB common to sq's AK and AF + (tri. ACG = tri. ABH) + (tri. CKM = trap. CEDL + tri. BNF) + (tri. KNM = tri. CLG) = sq. GE + sq. AF.

\therefore sq. upon AB = sq. upon BH + sq. upon AH. $\therefore h^2 = a^2 + b^2$.

a. See Edwards' Geom., 1895, p. 156, fig. (8).

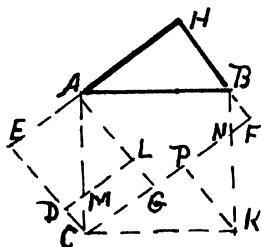
One Hundred Sixty-Nine

Fig. 267

In fig. 267, extend ED to C and draw KP par. to HB.

Sq. AK = quad. AGNB common to sq's AK and HG + (tri. ACG = tri. CAE = trap. EDMA + tri. BNF) + (tri. CKP = tri. ABH) + (tri. PKN = tri. LAM) = sq. AD + sq. AF.

\therefore sq. upon AB = sq. upon BH + sq. upon AH. $\therefore h^2 = a^2 + b^2$.

a. See Am. Math. Mo., V. VI, 1899, p. 33, proof LXXXVI.

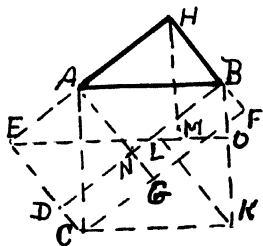
One Hundred Seventy

Fig. 268

In fig. 268, extend ED to C, DN to B, and draw EO par. to AB, KL perp. to DB and HM perp. to EO.

Sq. AK = rect. AO + rect. CO = paral. AELB + paral. ECKL = sq. AD + sq. AF.

\therefore sq. upon AB = sq. upon BH = sq. upon AH. $\therefore h^2 = a^2 + b^2$.

a. See Am. Math. Mo., Vol. VI, 1899, p. 33, LXXXVIII.

One Hundred Seventy-One

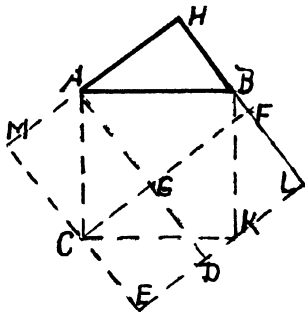


Fig. 269

In fig. 269, extend HF to L and complete the sq. HE.

Sq. AK = sq. HE - 4 tri. ABH = sq. CD + sq. HG + (2 rect. GL = 4 tri. ACG) - 4 tri. ABH = sq. CD + sq. HC.

\therefore sq. upon AB = sq. upon BH + sq. upon AH. $\therefore h^2 = a^2 + b^2$.

a. This is one of the conjectured proofs of Pythagoras; see Ball's Short Hist.

of Math., 1888, p. 24; Hopkins' Plane Geom., 1891, p. 91, fig. IV; Edwards' Geom., 1895, p. 162, fig. (39); Beman and Smith's New Plane Geom., 1899, p. 103, fig. 2; Heath's Math. Monographs, No. 1, 1900, p. 18, proof II.

One Hundred Seventy-Two

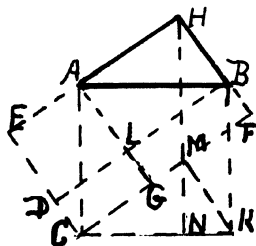


Fig. 270

In fig. 270, extend FG to C, draw HN perp. to CK and KM par. to HB.

Sq. AK = rect. BN + rect. AN = paral. BHMK + paral. HACM = sq. AD + sq. AF.

\therefore sq. upon AB = sq. upon BH + sq. upon AH. $\therefore h^2 = a^2 + b^2$.

a. See Am. Math. Mo., V. VI, 1899, p. 33, proof LXXXVII.

b. In this figure the given triangle may be either ACG, CKM, HMF or BAL; taking either of these four triangles

several proofs for each is possible. Again, by inspection, we observe that the given triangle may have any one of seven other positions within the square AGFH, right angles coinciding. Furthermore the square upon the hypotenuse may be constructed overlapping, and for each different supposition as to the figure there will result several proofs unlike any, as to dissection, given heretofore.

c. The simplicity and applicability of figures under Case (2), (b) makes it worthy of note.

One Hundred Seventy-Three

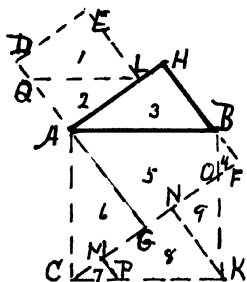


Fig. 271

In fig. 271, sq. AK = sections [5 + (6 = 3) + (7 = 4)] + [(8 = 1) + (9 = 2)] = sq. HG + sq. AE.

\therefore sq. upon AB = sq. upon BH + sq. upon HA. $\therefore h^2 = a^2 + b^2$. Q.E.D.

a. Devised by Richard Bell, Cleveland, O., on July 4, 1914, one of his 40 proofs.

One Hundred Seventy-Four

Case (2), (c).

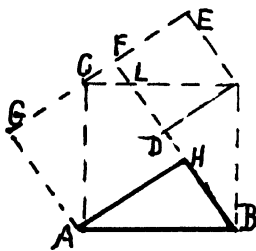


Fig. 272

In fig. 272, ED being the sq. translated, the construction is evident.

Sq. AK = quad. AHLC common to sq's AK and AF + (tri. ABC = tri. ACG) + (tri. BKD = trap. LKEF + tri. CLF) + tri. KLD common to sq's AK and ED = sq. ED + sq. AF.

\therefore sq. upon AB = sq. upon BH + sq. upon AH. $\therefore h^2 = a^2 + b^2$.

a. See Jury Wipper, 1880, p. 22, fig. 17, as given by von Hauff, in "Lehrbegriff der reinen Mathematik," 1803; Heath's Math. Monographs, 1900, No. 2, proof XX; Versluys, p. 29, fig. 27; Fourrey, p. 85--A. Marre, from Sanscrit, "Yoncti Bacha"; Dr. Leitzmann, p. 17, fig. 19, 4th edition.

One Hundred Seventy-Five

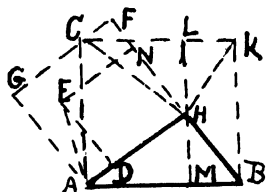


Fig. 273

Having completed the three squares AK, HE and HG, draw, through H, LM perp. to AB and join HC, AN and AE.

$$\begin{aligned} \text{Sq. AK} &= [\text{rect. LB} \\ &= 2(\text{tri. KHP} = \text{tri. AEM}) = \text{sq. HD}] \\ &+ [\text{rect. LA} = 2(\text{tri. HCA} = \text{tri.} \\ &\text{ACH}) = \text{sq. HG}] = \text{sq. HD} + \text{sq. HG.} \\ \therefore \text{sq. upon AB} &= \text{sq. upon} \\ &\text{HB} + \text{sq. upon HA.} \quad \therefore h^2 = a^2 + b^2. \end{aligned}$$

a. See Math. Mo. (1859), Vol. II, No. 2, Dem. 14, fig. 6.

One Hundred Seventy-Six

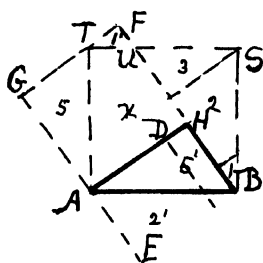


Fig. 274

In fig. 274, since parts 2 + 3 = sq. on BH = sq. DE, it is readily seen that the sq. upon AB = sq. upon BH + sq. upon AH. $\therefore h^2 = a^2 + b^2$.

a. Devised by Richard A. Bell, July 17, 1918, being one of his 40 proofs. He submitted a second dissection proof of same figure, also his 3 proofs of Dec. 1 and 2, 1920 are similar to the above, as to figure.

One Hundred Seventy-Seven

Case (2), (d).

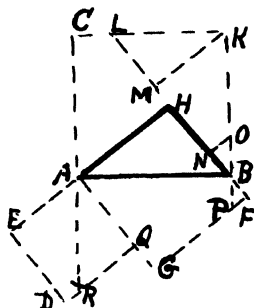


Fig. 275

In fig. 275, extend KB to P, CA to R, BH to L, draw KM perp. to BL, take MN = HB, and draw NO par. to AH.

Sq. AK = tri. ABH common to sq's AK and AF + (tri. BON = tri. BPF) + (trap. NOKM = trap. DRAE) + (tri. KLM = tri. ARQ) + (quad. AHLC = quad. AGPB) = sq. AD + sq. AF.

\therefore sq. upon AB = sq. upon BH + sq. upon AH. $\therefore h^2 = a^2 + b^2$.

a. See Am. Math. Mo., V. VI, 1899, p. 34, proof XC.

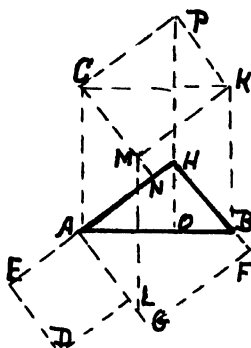
One Hundred Seventy-Eight

Fig. 276

In fig. 276, upon CK const. tri. CKP = tri. ABH, draw CN par. to BH, KM par. to AH, draw ML and through H draw PO.

Sq. AK = rect. KO + rect. CO = (paral. PB = paral. CL = sq. AD) + (paral. PA = sq. AF) = sq. AD + sq. AF.

\therefore sq. upon AB = sq. upon BH + sq. upon AH. $\therefore h^2 = a^2 + b^2$.

a. Original with the author, July 28, 1900.

b. An algebraic proof comes readily from this figure.

One Hundred Seventy-Nine

Case (3), (a).

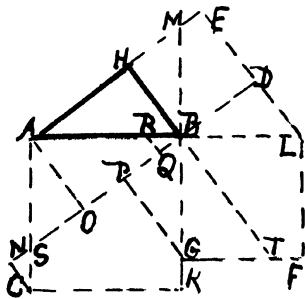


Fig. 277

$= a^2 + b^2.$

a. DeVised for missing Case (3), (a), March 17, 1926.

In fig. 277, produce DB to N, HB to T, KB to M, and draw CN, AO, KP and RQ perp. to NB.

Sq. AK = (quad. CKPS + tri. BRQ = trap. BTFL) + (tri. KBP = tri. TBG) + (trap. OQRA = trap. MBDE) + (tri. ASO = tri. BMH) = sq. HD + sq. GL.

∴ sq. upon AB = sq. upon BH + sq. upon AH. ∴ h^2

One Hundred Eighty

Case (3), (b).

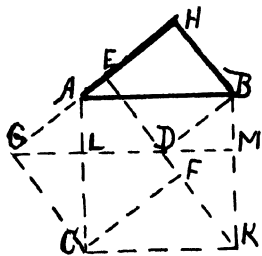


Fig. 278

In fig. 278, extend ED to K and through D draw GM par. to AB.

Sq. AK = rect. AM + rect. CM = (paral. GB = sq. HD) + (paral. CD = sq. GF) = sq. HD + sq. GF.

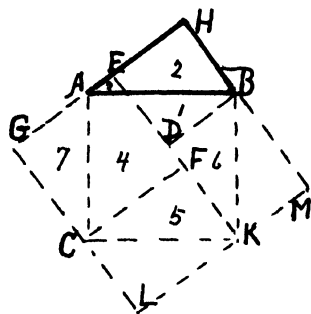
∴ sq. upon AB = sq. upon BH + sq. upon AH. ∴ $h^2 = a^2 + b^2.$

a. See Am. Math. Mo.,

Vol. VI, 1899, p. 33, proof LXXXV.

b. This figure furnishes an algebraic proof.

c. If any of the triangles congruent to tri. ABH is taken as the given triangle, a figure expressing a different relation of the squares is obtained, hence covering some other case of the 19 possible cases.

One Hundred Eighty-One

, Fig. 279

Extend HA to G making $AG = HB$, HB to M making $BM = HA$, complete the square's HD, EC, AK and HL. Number the dissected parts, omitting the tri's CLK and KMB.

Sq. $(AK = 1 + 4 + 5 + 6) =$ parts (1 common to sq's HD and AK) + (4 common to sq's EC and AK) + (5 = 2 of sq. HD + 3 of sq. EC) + (6 = 7 of sq. EC) = parts (1 + 2) + parts (3 + 4 + 7) = sq. HD + sq. EC.

\therefore sq. upon AB = sq.

upon BH + sq. upon AH. $\therefore h^2 = a^2 + b^2$. Q.E.D.

a. See "Geometric Exercises in Paper Folding" by T. Sundra Row, edited by Beman and Smith (1905), p. 14.

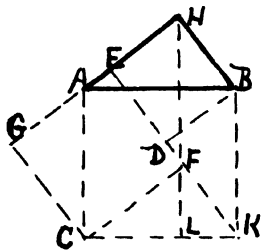
One Hundred Eighty-Two

Fig. 280

In fig. 280, extend EF to K, and HL perp. to CK.

Sq. AK = rect. BL + rect. AL = paral. BF + paral. AF = sq. HD + sq. GF.

\therefore sq. upon AB = sq. upon BH + sq. upon AH. $\therefore h^2 = a^2 + b^2$.

a. See Am. Math. Mo., V. VI, 1899, p. 33, proof LXXXIV.

One Hundred Eighty-Three

In fig. 281, extend EF to K.

Sq. AK = quad. ACFL common to sq's AK and GF

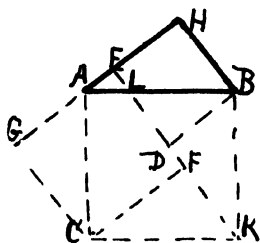


Fig. 281

+ (tri. CKF = trap. LBHE + tri. ALE) + (tri. KBD = tri. CAG) + tri. BDL common to sq's AK and HD = sq. HD + sq. AB.

\therefore sq. upon AB = sq. upon BH + sq. upon AH. $\therefore h^2 = a^2 + b^2$.

a. See Olney's Geom., Part III, 1872, p. 250, 2nd method; Jury Wipper, 1880, p. 23, fig. 18; proof by E. Forbes, Winchester, N.H., as given in Jour. of

Ed'n, V. XXVIII, 1888, p. 17, 25th proof; Jour. of Ed'n, V. XXV, 1887, p. 404, fig. II; Hopkins' Plane Geom., 1891, p. 91, fig. III; Edwards' Geom., 1895, p. 155, fig. (5); Math. Mo., V. VI, 1899, p. 33, proof LXXXIII; Heath's Math. Monographs, No. 1, 1900, p. 21, proof V; Geometric Exercises in Paper Folding, by T. Sundra Row, fig. 13, p. 14 of 2nd Edition of The Open Court Pub. Co., 1905. Every teacher of geometry should use this paper folding proof.

Also see Versluys, p. 29, fig. 26, 3rd paragraph, Clairaut, 1741, and found in "Yoncti Bacha"; also Math. Mo., 1858, Vol. I, p. 160, Dem. 10, and p. 46, Vol. II, where credited to Rev. A. D. Wheeler.

b. By dissection an easy proof results. Also by algebra, as (in fig. 281) $CKBHG = a^2 + b^2 + ab$; whence readily $h^2 = a^2 + b^2$.

c. Fig. 280 is fig. 281 with the extra line HL; fig. 281 gives a proof by congruency, while fig. 280 gives a proof by equivalency, and it also gives a proof, by algebra, by the use of the mean proportional.

d. Versluys, p. 20, connects this proof with Macay; Van Schooter, 1657; J. C. Sturm, 1689; Dobriner; and Clairaut.

One Hundred Eighty-Four

In fig. 282, from the dissection it is obvious that the sq. upon AB = sq. upon BH + sq. upon AH.

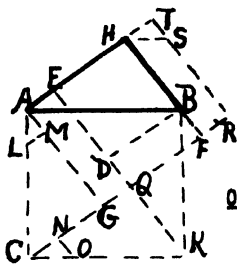


Fig. 282

$$\therefore AB^2 = BH^2 + HA^2, \text{ or } h^2 = a^2 + b^2.$$

a. Devised by R. A. Bell, Cleveland, O., on Nov. 30, 1920, and given to the author Feb. 28, 1938.

One Hundred Eighty-Five

Case (3), (c).

In fig. 283, draw KL perp. to CG and extend BH to M.

Sq. AK = (tri. ABH = tri. CKF) + tri. BNH common to sq's AK and HD + (quad. CGNK = sq. LH + trap. MHNK + tri. KCL common to sq's AK and FG) + tri. CAG = trap. BDEN + tri. KNE) = sq. HD + sq. FG.
 \therefore sq. upon AB = sq. upon BH + sq. upon AH. $\therefore h^2 = a^2 + b^2$.
 Q.E.D.

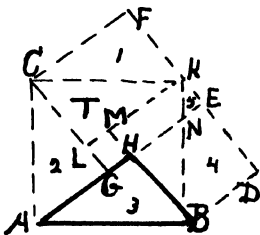


Fig. 283

a. See Sci. Am. Sup., Vol. 70, p. 383, Dec. 10, 1910, in which proof A. R. Colburn makes T the given tri., and then substitutes part 2 for part 1, part 3 for parts 4 and 5, thus showing sq. AK = sq. HD + sq. FG; also see Versluys, p. 31, fig. 28, Geom., of M. Sauvens, 1753 (1716).

One Hundred Eighty-Six

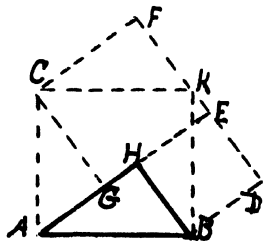


Fig. 284

In fig. 284, the construction is evident, FG being the translated b-square.

Sq. AK = quad. GLKC common to sq's AK and CE + (tri. CAG = trap. BDEL + tri. KLE) + (tri. ABH = tri. CKF) + tri. BLH common to sq's AK and HD = sq. HD + sq. CE.

\therefore sq. upon AB = sq. upon BH + sq. upon AH.
 $\therefore h^2 = a^2 + b^2$.

a. See Halsted's Elements of Geom., 1895, p. 78, theorem XXXVII; Edwards' Geom., 1895, p. 156, fig. (6); Heath's Math. Monographs, No. 1, 1900, p. 27, proof XIII.

One Hundred Eighty-Seven

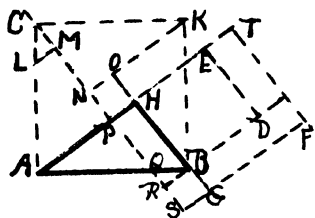


Fig. 285

In fig. 285 it is obvious that the parts in the sq. HD and HF are the same in number and congruent to the parts in the square AK.

\therefore the sq. upon AB = sq. upon BH + sq. upon AH, or $h^2 = a^2 + b^2$.

a. One of R. A. Bell's proofs, of Dec. 3, 1920 and received Feb. 28, 1938.

One Hundred Eighty-Eight

Case (3), (d).

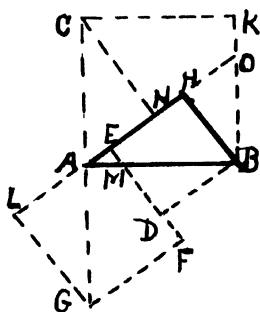


Fig. 286

In fig. 286, produce AH to O, draw CN par. to HB, and extend CA to G.

Sq. AK = trap. EMBH common to sq's AK and HD + (tri. BOH = tri. BMD) + (quad. NOKC = quad. FMAG) + (tri. CAN = tri. GAL) + tri. AME common to sq's AK and EG = sq. HD + sq. LF.

\therefore sq. upon AB = sq. upon BH + sq. upon AH. $\therefore h^2 = a^2 + b^2$.

a. See Am. Math. Mo., Vol. VI, 1899, p. 34, proof

LXXXIX.

b. As the relative position of the given triangle and the translated square may be indefinitely

varied, so the number of proofs must be indefinitely great, of which the following two are examples.

One_Hundred_Eighty-Nine

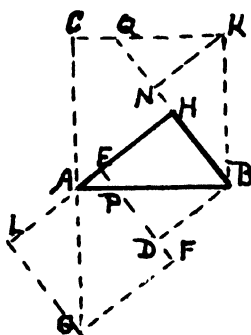


Fig. 287

In fig. 287, produce BH to Q, HA to L and ED to F, and draw KN perp. to QB and connect A and G.

Sq. AK = tri. APE common to sq's AK and EG + trap. PBHE common to sq's HD and AK + (tri. BKN = tri. GAL) + (tri. NKQ = tri. DBP) + (quad. AHQC = quad. GFP A) = sq. HD + sq. HA.

\therefore sq. upon AB = sq. upon HD + sq. upon HA. $\therefore h^2 = a^2 + b^2$.

a. This fig. and proof due to R. A. Bell of Cleveland, O. He gave it to the author Feb. 27, 1938.

One_Hundred_Ninety

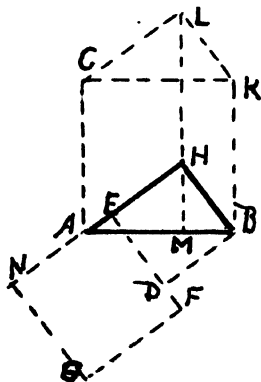


Fig. 288

In fig. 288, draw LM through H.

Sq. AK = rect. KM + rect. CM = paral. KH + paral. CH = sq. HD + (sq. on AH = sq. NF).

\therefore sq. upon AB = sq. upon BH + sq. upon AH. $\therefore h^2 = a^2 + b^2$.

a. Original with the author, July 28, 1900.

b. An algebraic solution may be devised from this figure.

One_Hundred_Ninety-One

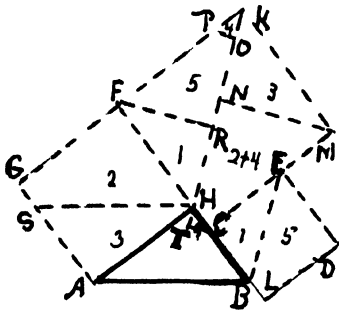


Fig. 289

Case (4), (a).

In fig. 289, extend KH to T making NT = AH, draw TC, draw FR, MN and PO perp. to KH, and draw HS par. to AB.

Sq. CK = (quad. CMNH + tri. KPO = quad. SHFG) + tri. MKN = tri. HSA) + (trap. FROP = trap. EDLB) + (tri. FHR = tri. ECB) = sq. CD + sq. GH.

∴ sq. upon AB = sq. upon BH + sq. upon AH. ∴ $h^2 = a^2 + b^2$.

a. Devised by author for case (4), (a) March 18, 1926.

One_Hundred_Ninety-Two

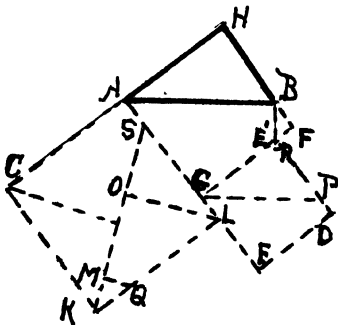


Fig. 290

Case (4), (b).

In fig. 290, draw GP par. to AB, take LS = AH, draw KS, draw LO, CN and QM perp. to KS, and draw BR.

Sq. AK = (tri. CNK = tri. ABH) + (tri. KQM = tri. FBR) + (trap. QLOM = trap. PGED) + (tri. SOL = tri. GPR) + (quad. CNSA = quad. AGRB) = sq. GD + sq. AF.

∴ sq. upon AB = sq. upon BH + sq. upon AH. ∴ $h^2 = a^2 + b^2$.

a. Devised by author for Case (4), (b).

One Hundred Ninety-Three

Case (5), (a).

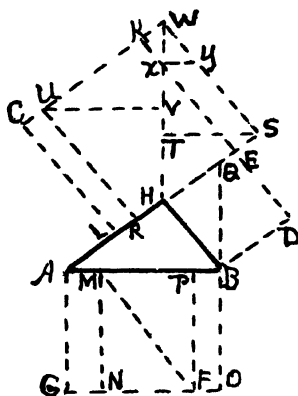


Fig. 291

In fig. 291, CE and AF are the translated sq's; produce GF to O and complete the sq. MO; produce HE to S and complete the sq. US; produce OB to Q, draw MF, draw WH, draw ST and UV perp. to WH, and take TX = HB and draw XY perp. to WH. Since sq. MO = sq. AF, and sq. US = sq. CE, and since sq. RW = (quad. URHV + tri. WYX = trap. MFOB + (tri. HST = tri. BQH) + (trap. TSYX = trap. BDEQ) + tri. UVW = tri. MFN) = sq. HD + (sq. NB = sq. AF).

\therefore sq. RW = sq. upon AB = sq. upon BH + sq. upon AH. $\therefore h^2 = a^2 + b^2$.

a. Devised March 18, 1926, for Case (5), (a), by author.

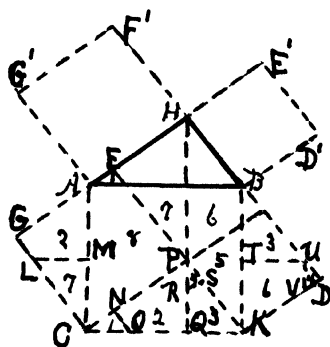
One Hundred Ninety-Four

Fig. 292

Extend HA to G making AG = HB; extend HB to D making BD = HA. Complete sq's PD and PG, Draw HQ perp. to CK and through P draw LM and TU par. to AB. PR = CO = BW.

The translated sq's are PD = BE' and PG = HG'.

Sq. AK = parts (1 + 2 + 3 + 4 + 5 + 6 + 7 + 8) = parts (3 + 4 + 5 + 6 = sq. PD) + parts (1 + 2 + 7 + 8) = sq. PG.

\therefore sq. upon AB = sq. upon HB + sq. upon HA.
 $\therefore h^2 = a^2 + b^2$. Q.E.D.

a. See Versluys, p. 35, fig. 34.

One Hundred Ninety-Five

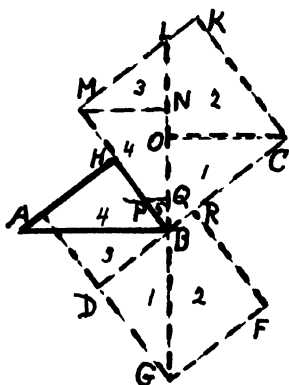


Fig. 293

Case (5), (b).

In fig. 293, draw GL through B, and draw PQ, CO and MN perp. to BL.

Sq. BK = (tri. CBO = tri. BGD) + (quad. OCKL + tri. BPO = trap. GFRB) + (tri. MLN = tri. BSD) + (trap. PQNM = trap. SEHB) = sq. HD + sq. DF.

\therefore sq. upon AB = sq. upon BH + sq. upon AH. $\therefore h^2 = a^2 + b^2$.

a. DeVised for Case (5), (b), by the author, March 28, 1926.

One Hundred Ninety-Six

Case (6), (a).

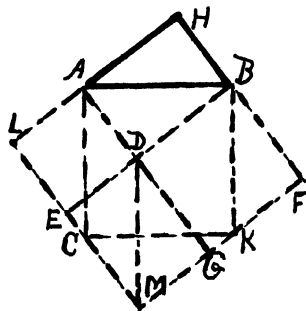


Fig. 294

In fig. 294, extend LE and FG to M thus completing the sq. HM, and draw DM.

Sq. AK + 4 tri. ABC = sq. HM = sq. LD + sq. DF + (2 rect. HD = 4 tri. ABC), from which sq. AK = sq. LD + sq. DF.

\therefore sq. upon AB = sq. upon BH + sq. upon AH. $\therefore h^2 = a^2 + b^2$.

a. This proof is credited to M. McIntosh of Whitwater, Wis. See Jour. of Ed'n, 1888, Vol. XXVII, p. 327, seventeenth proof.

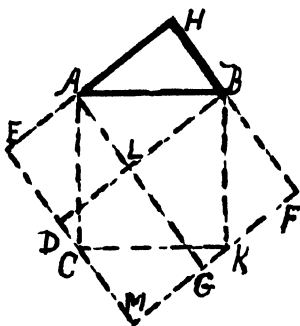
One Hundred Ninety-Seven

Fig. 295

Sq. AK = sq. HM - (4
tri. ABH = 2 rect. HL = sq. EL
+ sq. LF + 2 rect. HL - 2 rect.
HL = sq. EL + sq. LF.

\therefore sq. upon AB = sq.
upon HB + sq. upon HA. $\therefore h^2$
= $a^2 + b^2$.

a. See Journal of Edu-
cation, 1887, Vol. XXVI, p. 21,
fig. XII; Iowa Grand Lodge Bul-
letin, F and A.M., Vol. 30, No.
2, p. 44, fig. 2, of Feb. 1929.
Also Dr. Leitzmann, p. 20, fig.
24, 4th Ed'n.

b. An algebraic proof is $h^2 = (a + b)^2 - 2ab$
= $a^2 + b^2$.

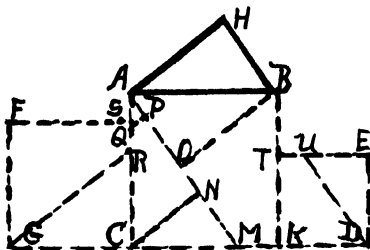
One Hundred Ninety-Eight

Fig. 296

In fig. 296, the
translation is evident.
Take CM = KD. Draw AM;
then draw GR, CN and BO
par. to AH and DU par. to
BH. Take NP = BH and
draw PQ par. to AH.

Sq. AK = (tri.
CMN = tri. DEU) + (trap.
CNPQ = trap. TKDU)
+ (quad. OMRB + tri. AQP)
= trap. FGRQ) + tri. AOB

= tri. GCR) = sq. EK + sq. FC.

\therefore sq. upon AB = sq. upon HB + sq. upon HA.

$\therefore h^2 = a^2 + b^2$. Q.E.D.

a. Devised by the author, March 28, 1926.



NICOLAI IVANOVITCH LOBACHEVSKY

1793-1856

One Hundred Ninety-Nine

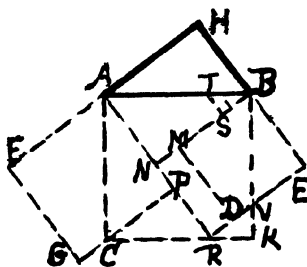


Fig. 297

In fig. 297, the translation and construction is evident.

$$\begin{aligned} \text{Sq. AK} &= (\text{tri. CRP} \\ &= \text{tri. BVE}) + (\text{trap. ANST} \\ &= \text{trap. BMDV}) + (\text{quad. NRKB} \\ &+ \text{tri. TSB} = \text{trap. AFGC}) + \text{tri.} \\ &\text{ACP common to sq. AK and AG} \\ &= \text{sq. ME} + \text{sq. FP.} \end{aligned}$$

$$\begin{aligned} \therefore \text{sq. upon AB} &= \text{sq.} \\ &\text{upon BH} + \text{sq. upon AH.} \therefore h^2 \\ &= a^2 + b^2. \end{aligned}$$

a. Devised by author, March 26, 1926, 10 p.m.

Two Hundred

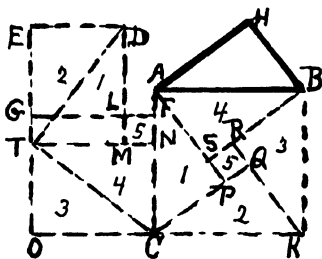


Fig. 298

In fig. 298, the sq. on AH is translated to position of GC, and the sq. on HB to position of GD. Complete the figure and conceive the sum of the two sq's EL and GC as the two rect's EM + TC + sq. LN and the dissection as numbered.

$$\begin{aligned} \text{Sq. AK} &= (\text{tri. ACP} \\ &= \text{tri. DTM}) + (\text{tri. CKQ} \\ &= \text{tri. TDE}) + (\text{tri. KBR} \\ &= \text{tri. CTO}) + (\text{tri. BAS} \end{aligned}$$

$$\begin{aligned} &= \text{tri. TCN}) + (\text{sq. SQ} = \text{sq. LN}) = \text{sq. EL} + \text{sq. GC.} \\ \therefore \text{sq. upon AB} &= \text{sq. upon BH} + \text{sq. upon AH.} \\ \therefore h^2 &= a^2 + b^2. \end{aligned}$$

a. Devised by author, March 22, 1926.

b. As sq. EL, having a vertex and a side in common with a vertex and a side of sq. GC, either externally (as in fig. 298), or internally, may have 12 different positions, and as sq. GC may have a vertex

and a side in common with the fixed sq. AK, or in common with the given triangle ABH, giving 15 different positions, there is possible $180 - 3 = 177$ different figures, hence 176 proofs other than the one given above, using the dissection as used here, and 178 more proofs by using the dissection as given in proof Ten, fig. 111.

c. This proof is a variation of that given in proof Eleven, fig. 112.

Two Hundred One

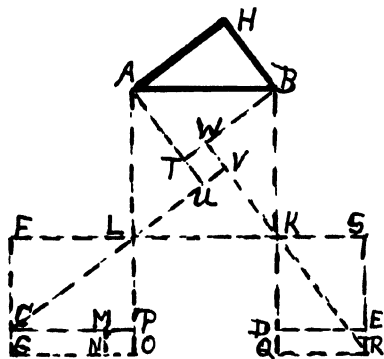


Fig. 299

In fig. 299, the construction is evident, as FO is the translation of the sq. on AH, and KE is the translation of the sq. on BH.

Since rect. CN = rect. QE, we have sq. AK = (tri. LKV = tri. CPL) + (tri. KBW = tri. LFC) + (tri. BAT = tri. KQR) + (tri. ALU = tri. RSK) + (sq. TV = sq. MO) = rect. KR + rect. FP + sq. MO = sq. KE + sq. FO.

\therefore sq. upon AB = sq. upon BH + sq. upon AH.

$$\therefore h^2 = a^2 + b^2.$$

a. Devised by the author, March 27, 1926.

Two Hundred Two

In fig. 300 the translation and construction are easily seen.

Sq. AK = (tri. CKN = tri. LFG) + (trap. OTUM = trap. RESA) + (tri. VOB = tri. RAD) + (quad. ACNV + tri. TKU = quad. MKFL) = sq. DS + sq. MF.

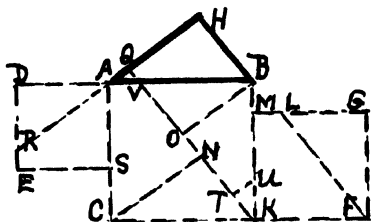


Fig. 300

\therefore sq. upon AB = sq. upon HB + sq. upon HA. $\therefore h^2 = a^2 + b^2$.

a. Devised by the author, March 27, 1926, 10:40 p.m.

Two Hundred Three

AR = AH and AD = BH. Complete sq's on AR and AD. Extend DE to S and draw SA and TR.

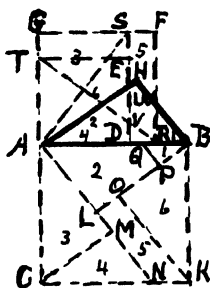


Fig. 301

Sq. AK = (tri. QPB = tri. VDR of sq. AF) + (trap. ALPQ = trap. ETAU of sq. AE) + (tri. CMA = tri. SGA of sq. AF) + (tri. CNM = tri. UAD of sq. AE) + (trap. NKOL = trap. VRFS of sq. AF) + (tri. OKB = tri. DSA of sq. AF) = (parts 2 + 4 = sq. AE) + (parts 1 + 3 + 5 + 6 = sq. AF).

\therefore sq. upon AB = sq. upon HB + sq. upon HA. $\therefore h^2 = a^2 + b^2$. Q.E.D.

a. Devised, by author, Nov. 16, 1933.

Two Hundred Four

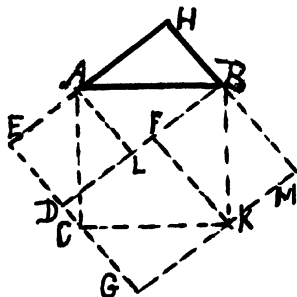


Fig. 302

In fig. 302, complete the sq. on EH, draw BD par. to AH, and draw AL and KF perp. to DB.

Sq. AK = sq. HG - (4 tri. ABH = 2 rect. HL) = sq. EL + sq. DK + 2 rect. FM - 2 rect. HL = sq. EL + sq. DK.

\therefore sq. upon AB = sq. upon HB + sq. upon HA. $\therefore h^2 = a^2 + b^2$.

- (19).
- See Edwards' Geom., 1895, p. 158, fig.
 - By changing position of sq. FG, many other proofs might be obtained.
 - This is a variation of proof, fig. 240.

Two Hundred Five

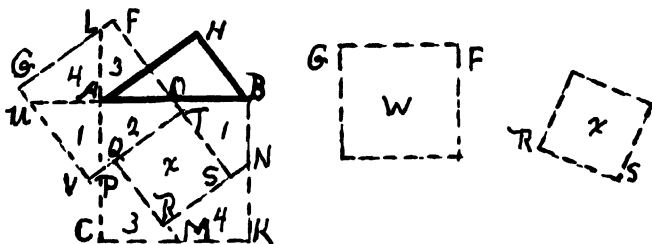


Fig. 303

In fig. 303, let W and X be sq's with sides equal resp'y to AH and BH. Place them as in figure, A being center of sq. W, and O, middle of AB as center of FS. ST = BH, TF = AH. Sides of sq's FV and QS are perp. to sides AH and BH.

It is obvious that:

Sq. AK = (parts 1 + 2 + 3 + 4 = sq. FV) + sq.

QS = sq. X + sq. W.

\therefore sq. upon AB = sq. upon HB + sq. upon HA.

$\therefore h^2 = a^2 + b^2$.

a. See Messenger of Math., Vol. 2, p. 103, 1873, and there credited to Henry Perigal, F.R.S.A.S.

Two Hundred Six

Case (6), (b).

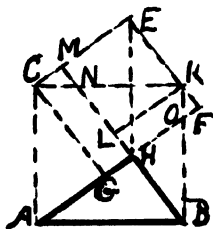


Fig. 304

In fig. 304, the construction is evident. Sq. AK = (tri. ABH = trap. KEMN + tri. KOF) + (tri. BOH = tri. KLN) + quad. GOKC common to sq's AK and CF + (tri. CAG = tri. CKE) = sq. MK + sq. CF.

\therefore sq. upon AB = sq. upon BH + sq. upon AH.
 $\therefore h^2 = a^2 + b^2$. Q.E.D.

a. See Hopkins' Plane Geom., 1891, p. 92, fig fig. VIII.

b. By drawing a line EH, a proof through parallelogram, may be obtained. Also an algebraic proof.

c. Also any one of the other three triangles, as CAG may be called the given triangle, from which other proofs would follow. Furthermore since the tri. ABH may have seven other positions leaving side of sq. AK as hypotenuse, and the sq. MK may have 12 positions having a side and a vertex in common with sq. CF, we would have 84 proofs, some of which have been or will be given; etc., etc., as to sq. CF, one of which is the next proof.

Two Hundred Seven

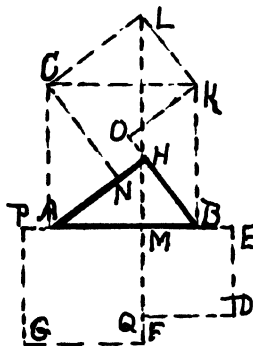


Fig. 305

In fig. 305, through H draw LM, and draw CN par. to BH and KO par. to AH.

Sq. AK = rect. KM + rect. CM = paral. KH + paral. CH = HB \times KO + AH \times CN = sq. on BH + sq. on AH = sq. MD + sq. MG.

\therefore sq. upon AB = sq. upon BH + sq. upon AH. $\therefore h^2 = a^2 + b^2$.

a. Original with the author January 31, 1926, 3 p.m.

Two Hundred Eight

Case (7), (a).

In fig. 306, extend AB to X, draw WU and KS each = to AH and par. to AB, CV and HT perp. to AB, GR and FP par. to AB, and LW and AM perp. to AB.

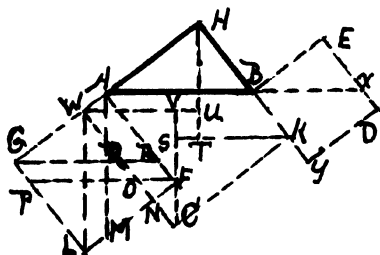


Fig. 306

$\therefore h^2 = a^2 + b^2$. Q.E.D.

a. Original with the author, Aug. 8, 1900.

b. As in fig. 305 many other arrangements are possible each of which will furnish a proof or proofs.

J

(A)--Proofs determined by arguments based upon a square.

This type includes all proofs derived from figures in which one or more of the squares are not graphically represented. There are two leading classes or sub-types in this type--first, the class in which the determination of the proof is based upon a square; second, the class in which the determination of the proof is based upon a triangle.

As in the I-type, so here, by inspection we find 6 sub-classes in our first sub-type which may be symbolized thus:

- (1) The h-square omitted, with
 - (a) The a- and b-squares const'd outwardly--3 cases.
 - (b) The a-sq. const'd out'ly and the b-sq. overlapping--3 cases.
 - (c) The b-sq. const'd out'ly and the a-sq. overlapping--3 cases.
 - (d) The a- and b-squares overlapping--3 cases.

Sq. WK = (tri. CKS
 = tri. FPL = trap. BYDX
 of sq. BD + tri. FON of
 sq. GF) + (tri. TKH = tri.
 GRA = tri. BEX of sq. BD
 + trap. WQRA of sq. GF)
 + (tri. WUH = tri. LWG of
 sq. GF) + (tri. WCV = tri.
 WLN of sq. GF) + (sq. VT
 = paral. RO of sq. GF)
 = sq. BD + sq. GF.

\therefore sq. upon AB = sq.
 upon HB + sq. upon HA.

-
- (2) The a-sq. omitted, with
 - (a) The h- and b-sq's const'd out'ly--3 cases.
 - (b) The h-sq. const'd out'ly and the b-sq. overlapping--3 cases.
 - (c) The b-sq. const'd out'ly and the h-sq. overlapping--3 cases.
 - (d) The h- and b-sq's const'd and overlapping --3 cases.
 - (3) The b-sq. omitted, with
 - (a) The h- and a-sq's const'd out'ly--3 cases.
 - (b) The h-sq. const'd out'ly and the a-sq. overlapping--3 cases.
 - (c) The a-sq. const'd out'ly and the h-sq. overlapping--3 cases.
 - (d) The h- and a-sq's const'd overlapping--3 cases.
 - (4) The h- and a-sq's omitted, with
 - (a) The b-sq. const'd out'ly.
 - (b) The b-sq. const'd overlapping.
 - (c) The b-sq. translated--in all 3 cases.
 - (5) The h- and b-sq'd omitted, with
 - (a) The a-sq. const'd out'ly.
 - (b) The a-sq. const'd overlapping.
 - (c) The a-sq. translated--in all 3 cases.
 - (6) The a- and b-sq's omitted, with
 - (a) The h-sq. const'd out'ly.
 - (b) The h-sq. const'd overlapping.
 - (c) The h-sq. translated--in all 3 cases.

The total of these enumerated cases is 45. We shall give but a few of these 45, leaving the remainder to the ingenuity of the interested student.

- (7) All three squares omitted.

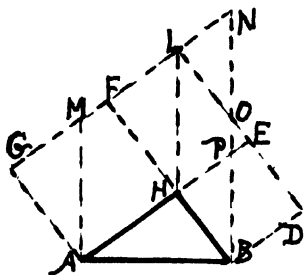
Two Hundred Nine

Fig. 307

Case (1), (a).

In fig. 307, produce GF to N a pt., on the perp. to AB at B, and extend DE to L, draw HL and AM perp. to AB. The tri's AMG and ABH are equal.

$$\begin{aligned} &\text{Sq. HD} + \text{sq. GH} \\ &= (\text{paral. HO} = \text{paral. LP}) \\ &+ \text{paral. MN} = \text{paral. MP} = \text{AM} \\ &\times \text{AB} = \text{AB} \times \text{AB} = (\text{AB})^2. \end{aligned}$$

$$\therefore \text{sq. upon AB} = \text{sq.}$$

upon BH + sq. upon AH. $\therefore h^2 = a^2 + b^2$.

a. Devised by author for case (1), (a),
March 20, 1926.

b. See proof No. 88, fig. 188. By omitting lines CK and HN in said figure we have fig. 307. Therefore proof No. 209 is only a variation of proof No. 88, fig. 188.

Analysis of proofs given will show that many supposedly new proofs are only modifications of some more fundamental proof.

Two Hundred Ten

(Not a Pythagorean Proof.)

While case (1), (b) may be proved in some other way, we have selected the following as being quite unique. It is due to the ingenuity of Mr. Arthur R. Colburn of Washington, D.C., and is No. 97 of his 108 proofs.

It rests upon the following Theorem on Parallelogram, which is: "If from one end of the side of a parallelogram a straight line be drawn to any point in the opposite side, or the opposite side extended, and a line from the other end of said first side be drawn perpendicular to the first line, or its

extension, the product of these two drawn lines will measure the area of the parallelogram." Mr. Colburn formulated this theorem and its use is discussed in Vol. 4, p. 45, of the "Mathematics Teacher," Dec., 1911. I have not seen his proof, but have demonstrated it as follows:

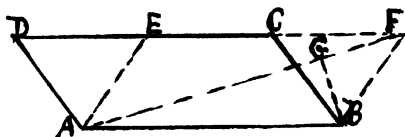


Fig. 308

In the paral. ABCD, from the end A of the side AB, draw AF to side DC produced, and from B, the other end of side AB, draw BG perp. to AF. Then $AF \times BG = \text{area of paral. ABCD}$.

Proof: From D lay off $DE = CF$, and draw AE and BF forming the paral. ABFE = paral. ABCD. ABF is a triangle and is one-half of ABFE. The area of tri. FAB = $\frac{1}{2}FA \times BG$; therefore the area of paral. ABFE = 2 times the area of the tri. FAB, or $FA \times BG$. But the area of paral. ABFE = area of paral. ABCD. $\therefore AF \times BG$ measures the area of paral. ABCD. Q.E.D.

By means of this Parallelogram Theorem the Pythagorean Theorem can be proved in many cases, of which here is one.

Two Hundred Eleven

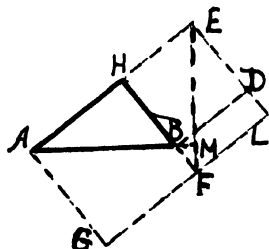


Fig. 309

Case (1), (b).

In fig. 309, extend GF and ED to L completing the paral. AL, draw FE and extend AB to M. Then by the paral. theorem:

- (1) $EF \times AM = AE \times AG$.
- (2) $EF \times BM = FL \times BF$.

$$(1) - (2) = (3) \quad EF(AM - BM) = AE \times AG - FL \times BF$$

(3) = (4) (EF = AB) \times AB = AGFH + BDEH, or sq. AB = sq. HG + sq. HD.

\therefore sq. upon AB = sq. upon BH + sq. upon AH.
 $\therefore h^2 = a^2 + b^2$.

a. This is No. 97 of A. R. Colburn's 108 proofs.

b. By inspecting this figure we discover in it the five dissected parts as set forth by my Law of Dissection. See proof Ten, fig. 111.

Two Hundred Twelve

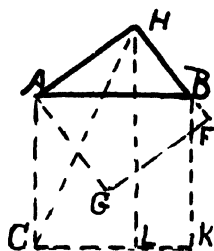


Fig. 310

Case (2), (b).

Tri. HAC = tri. ACH.

Tri. HAC = $\frac{1}{2}$ sq. HG.

Tri. ACH = $\frac{1}{2}$ rect. AL.

\therefore rect. AL = sq. HG. Similarly
 rect. BL = sq. on HB. But rect. AL
 + rect. BL = sq. AK.

\therefore sq. upon AK = sq. upon HB
 + sq. upon HA. $\therefore h^2 = a^2 + b^2$.
 Q.E.D.

a. Sent to me by J. Adams from The Hague, Holland. But the author not given. Received it March 2, 1934.

Two Hundred Thirteen

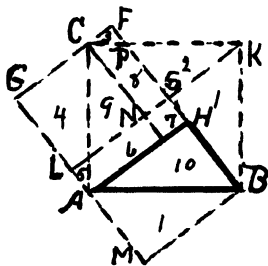


Fig. 311

Case (2), (c).

In fig. 311, produce GA to M making AM = HB, draw BM, and draw KL par. to AH and CO par. to BH.

Sq. AK = 4 tri. ABH + sq.

$$\begin{aligned} NH &= 4 \times \frac{AH \times BH}{2} + (AH - BH)^2 \\ &= 2AH \times BH + AH^2 - 2AH \times BH + \\ &BH^2 = BH^2 + AH^2. \end{aligned}$$

\therefore sq. upon AB = sq. upon BH + sq. upon AH.
 $\therefore h^2 = a^2 + b^2$.

a. Original with author, March, 1926.

b. See Sci. Am. Sup., Vol. 70, p. 383, Dec. 10, 1910, fig. 17, in which Mr. Colburn makes use of the tri. BAM.

c. Another proof, by author, is obtained by comparison and substitution of dissected parts as numbered.

Two Hundred Fourteen

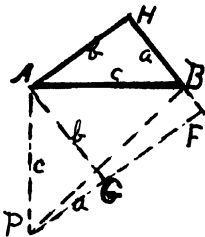


Fig. 312

Case (4), (b).

In fig. 312, produce FG to P making GP = BH, draw AP and BP.

Sq. GH = b^2 = tri. BHA + quad.

ABFG = tri. APG + quad. ABFG = tri.

APB + tri. PFB = $\frac{1}{2}c^2 + \frac{1}{2}(b+a)(b-a)$.

$\therefore b^2 = \frac{1}{2}c^2 + \frac{1}{2}b^2 - \frac{1}{2}a^2$. $\therefore c^2 = a^2 + b^2$.

\therefore sq. upon AB = sq. upon HB + sq. upon HA.

a. Proof 4, on p. 104, in "A Companion of Elementary School Mathematics," (1924) by F. C. Boon, B.A., Pub. by Longmans, Green and Co.

Two Hundred Fifteen

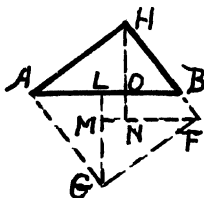


Fig. 313

In fig. 313, produce HB to F and complete the sq. AF. Draw GL perp. to AB, FM par. to AB and NH perp. to AB.

$$\text{Sq. AF} = \text{AH}^2 = 4 \frac{\text{AO} \times \text{HO}}{2}$$

$$+ [\text{LO}^2 = (\text{AO} - \text{HO})^2] = 2\text{AO} \times \text{HO} + \text{AO}^2 - 2\text{AO} \times \text{HO} + \text{HO}^2 = \text{AO}^2 + \text{HO}^2 = (\text{AO} + \text{HO})^2 = (\text{AH}^2 + \text{AB}^2) + (\text{HO} = \text{AH} \times \text{HB} \div \text{AB})^2 = \text{AH}^4 + \text{AB}^2 + \text{AH}^2 \times \text{HB}^2 \div \text{AB}^2 = \text{AH}^2 + \text{AB}^2$$

$$(\text{AH}^2 + \text{HB}^2) \div \text{AB}^2. \therefore 1 = (\text{AH}^2 + \text{BH}^2) \div \text{AB}^2. \therefore \text{AB}^2 = \text{BH}^2 + \text{AH}^2.$$

\therefore sq. upon AB = sq. upon HB + sq. upon HA.
 $\therefore h^2 = a^2 + b^2$.. Q.E.D.

a. See Am. Math. Mo., Vol. VI, 1899, p. 69, proof CIII; Dr. Leitzmann, p. 22, fig. 26.

b. The reader will observe that this proof proves too much, as it first proves that $AH^2 = AO^2 + HO^2$, which is the truth sought. Triangles ABH and AOH are similar, and what is true as to the relations of the sides of tri. AHO must be true, by the law of similarity, as to the relations of the sides of the tri. ABH.

Two Hundred Sixteen

Case (6), (a). This is a popular figure with authors.

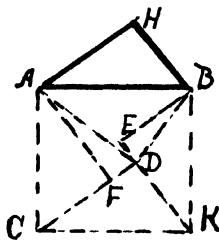


Fig. 314

In fig. 314, draw CD and KD par. respectively to AH and BH, draw AD and BD, and draw AF perp. to CD and BE perp. to KD extended.

Sq. AK = 2 tri. CDA + 2 tri. BDK = CD \times AF + KD \times EB = CD² + KD².
 \therefore sq. upon AB = sq. upon BH + sq. upon AH. $\therefore h^2 = a^2 + b^2$.

a. Original with the author, August 4, 1900.

Two Hundred Seventeen

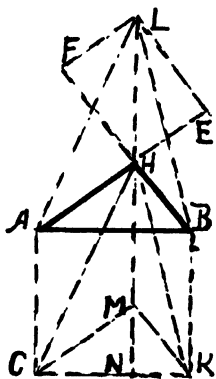


Fig. 315

In fig. 315, extend AH and BH to E and F respectively making HE = HB and HF = HA, and through H draw LN perp. to AB, draw CM and KM par. respectively to AH and BH, complete the rect. FE and draw LA, LB, HC and HK.

Sq. AK = rect. BN + rect. AN = paral. BM + paral. AM = (2 tri. HMK = 2 tri. LHB = sq. BH) + (2 tri. HAL = 2 tri. LAH = sq. AH).

\therefore sq. upon AB = sq. upon BH + sq. upon AH.
 $\therefore h^2 = a^2 + b^2$.

a. Original with author March 26, 1926,
 9 p.m.

Two Hundred Eighteen

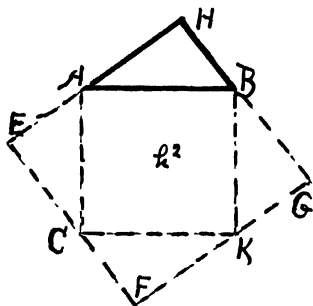


Fig. 316

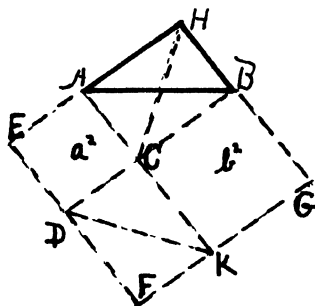


Fig. 317

In fig. 316, complete the sq's HF and AK; in fig. 317 complete the sq's HF, AD and CG, and draw HC and DK. Sq. HF - 4 tri. ABH = sq. AK = h^2 . Again sq. HF - 4 tri. ABH = $a^2 + b^2$. $\therefore h^2 = a^2 + b^2$.

\therefore sq. upon AB = sq. upon BH + sq. upon AH.

a. See Math. Mo., 1858, Dem. 9, Vol. I, p. 159, and credited to Rev. A. D. Wheeler of Brunswick, Me., in work of Henry Boad, London, 1733.

b. An algebraic proof: $a^2 + b^2 + 2ab = h^2 + 2ab$. $\therefore h^2 = a^2 + b^2$.

c. Also, two equal squares of paper and scissors.

Two Hundred Nineteen

In fig. 318, extend HB to N and complete the sq. HM.

$$\begin{aligned} \text{Sq. AK} &= \text{sq. HM} - 4 \frac{\text{HB} \times \text{HA}}{2} = (\text{LA} + \text{AH})^2 \\ &- 2\text{HB} \times \text{HA} = \text{LA}^2 + 2\text{LA} \times \text{AH} + \text{AH}^2 - 2\text{HB} \times \text{HA} = \text{BH}^2 \\ &+ \text{AH}^2. \end{aligned}$$

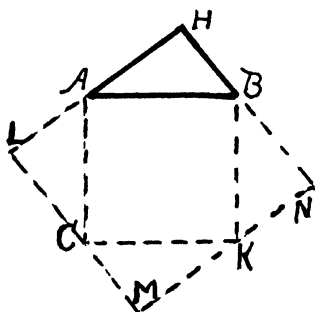


Fig. 318

1895, p. 159, fig. (27); Am. Math. Mo., Vol. VI, 1899, p. 70, proof XCIV; Heath's Math. Monographs, No. 1, 1900, p. 23, proof VIII; Sci. Am. Sup., Vol. 70, p. 359, fig. 4, 1910; Henry Boad's work, London, 1733.

b. For algebraic solutions, see p. 2, in a pamphlet by Artemus Martin of Washington, D.C., Aug. 1912, entitled "On Rational Right-Angled Triangles"; and a solution by A. R. Colburn, in Sci. Am. Supplement, Vol. 70, p. 359, Dec. 3, 1910.

c. By drawing the line AK, and considering the part of the figure to the right of said line AK, we have the figure from which the proof known as Garfield's Solution follows--see proof Two Hundred Thirty-One, fig. 330.

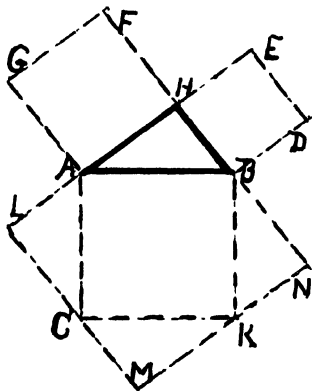


Fig. 319

\therefore sq. upon AB = sq. upon BH + sq. upon AH.

a. Credited to T. P. Stowell, of Rochester, N.Y. See The Math. Magazine, Vol. I, 1882, p. 38; Olney's Geom., Part III, 1872, p. 251, 7th method; Jour. of Ed'n, Vol. XXVI, 1877, p. 21, fig. IX; also Vol. XXVII, 1888, p. 327, 18th proof, by R. E. Binford, Independence, Texas; The School Visitor, Vol. IX, 1888, p. 5, proof II; Edwards' Geom.,

Two Hundred Twenty

In fig. 319, extend HA to L and complete the sq. LN.

$$\begin{aligned} \text{Sq. AK} &= \text{sq. LN} \\ - 4 \times \frac{\text{HB} \times \text{HA}}{2} &= (\text{HB} + \text{HA})^2 \\ - 2\text{HB} \times \text{HA} &= \text{HB}^2 + 2\text{HB} \times \text{HA} \end{aligned}$$

+ $HA^2 - 2HB \times HA = \text{sq. } HB + \text{sq. } HA. \therefore \text{sq. upon } AB = \text{sq. upon } BH + \text{sq. upon } AH. \therefore h^2 = a^2 + b^2.$

a. See Jury Wipper, 1880, p. 35, fig. 32, as given in "Hubert's Rudimenta Algebrae," Wurcebe, 1762; Versluys, p. 70, fig. 75.

b. This fig, 319 is but a variation of fig. 240, as also is the proof.

Two Hundred Twenty-One

Case (6), (b).

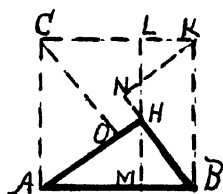


Fig. 320

In fig. 320, complete the sq. AK overlapping the tri. ABH, draw through H the line LM perp. to AB, extend BH to N making $BN = AH$, and draw KN perp. to BN, and CO perp. to AH. Then, by the parallelogram theorem, Case (1), (b), fig. 308, $\text{sq. } AK = \text{paral. } KM$

+ paral. $CM = (BH \times KN = a^2) + (AH \times CO = b^2) = a^2 + b^2.$

$\therefore \text{sq. upon } AB = \text{sq. upon } BH + \text{sq. upon } AH.$

a. See Math. Teacher, Vol. 4, p. 45, 1911, where the proof is credited to Arthur H. Colburn.

b. See fig. 324; which is more fundamental, proof No. 221 or proof No. 225?

c. See fig. 114 and fig. 328.

Two Hundred Twenty-Two

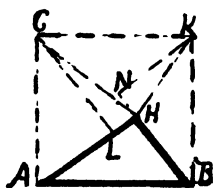


Fig. 321

In fig. 321, draw CL perp. to AH, produce BH to N making $BN = CL$, and draw KN and CH. Since $CL = AH$ and $KN = BH$, then $\frac{1}{2} \text{sq. } BC = \text{tri. } KBH + \text{tri. } AHC = \frac{1}{2} BH^2 + \frac{1}{2} AH^2$, or $\frac{1}{2} h^2 = \frac{1}{2} a^2 + \frac{1}{2} b^2. \therefore h^2 = a^2 + b^2.$

$\therefore \text{sq. upon } AB = \text{sq. upon } HB + \text{sq. upon } HA.$

a. Proof 5, on p. 104, in

"A Companion to Elementary Mathematics" (1924) by F. C. Boon, A.B., and credited to the late F. C. Jackson ("Slide Rule Jackson").

Two Hundred Twenty-Three

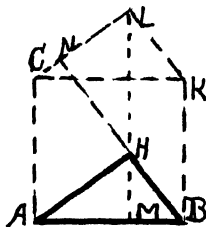


Fig. 322

In fig. 322, draw CL and KL par. to AH and BH respectively, and through H draw LM.

Sq. AK = rect. KM + rect. CM
= paral. KH + paral. CH = BH × NL
+ AH × NH = BH² + AH².

∴ sq. upon AB = sq. upon BH
+ sq. upon AH. ∴ h² = a² + b².
Q.E.D.

a. This is known as Haynes'

Solution. See the Math. Magazine,
Vol. I, p. 60, 1882; also said to

have been discovered in 1877 by Geo. M. Phillips, Ph. Ph.D., Prin. of the West Chester State Normal School, Pa.; see Heath's Math. Monographs, No. 2, p. 38, proof XXVI; Foureay, p. 76.

b. An algebraic proof is easily obtained.

Two Hundred Twenty-Four

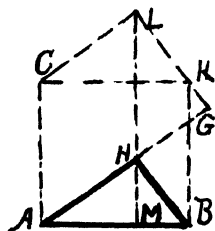


Fig. 323

In fig. 323, construct sq. AK. Extend AH to G making HG = HB; on CK const. rt. tri. CKL (= ABH) and draw the perp. LHM, and extend LK to G.

Now LG = HA, and it is obvious that: sq. AK (= h²) = rect. MK + rect. MC = paral. HK + paral. HC = HB × HG + HA × CL = b² + a², or h² = a² + b². Q.E.D.

∴ sq. upon AB = sq. upon HB
+ sq. upon HA.

a. This fig. (and proof) was devised by Gustav Cass, a pupil in the Junior-Senior High School,

South Bend, Ind., and sent to the author, by his teacher, Wilson Thornton, May 16, 1939.

Two Hundred Twenty-five

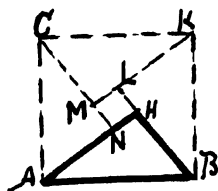


Fig. 324a

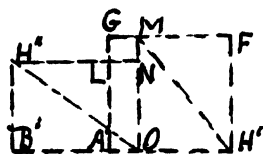


Fig. 324b

Case (6), (c).

For convenience designate the upper part of fig. 324, i.e., the sq. AK, as fig. 324a, and the lower part as 324b.

In fig. 324a, the construction is evident, for 324b is made from the dissected parts of 324a. GH' is a sq. each side of which = AH, LB' is a sq. each side of which = BH.

Sq. AK = 2 tri. ABH + 2 tri. ABH + sq. MH = rect. B'N + rect. OF + sq. LM = sq. B'L + sq. A'F.

\therefore sq. upon AB = sq. upon BH + sq. upon AH. $\therefore h^2 = a^2 + b^2$.

a. See Hopkins' Plane Geom., 1891, p. 91, fig. V; Am. Math. Mo., Vol. VI, 1899, p. 69, XCI; Beman and Smith's New Plane Geom., 1899, p. 104, fig. 3; Heath's Math. Monographs, No. 1, 1900, p. 20, proof IV. Also Mr. Bodo M. DeBeck, of Cincinnati, O., about 1905 without knowledge of any previous solution discovered above form of figure and devised a proof from it. Also Versluys, p. 31, fig. 29; and "Curiosities of Geometriques, Fourrey, p. 83, fig. b, and p. 84, fig. d, by Sanvens, 1753.

b. History relates that the Hindu Mathematician Bhaskara, born 1114 A.D., discovered the above proof and followed the figure with the single word "Behold," not condescending to give other than the figure and this one word for proof. And history furthermore declares that the Geometers of Hindustan knew the truth and proof of this theorem centuries before the time of Pythagoras--may he not have learned about it while studying Indian lore at Babylon?

Whether he gave fig. 324b as well as fig. 324a, as I am of the opinion he did, many late authors think not; with the two figures, 324a and 324b, side by side, the word "Behold!" may be justified, especially when we recall that the tendency of that age was to keep secret the discovery of truth for certain purposes and from certain classes; but with the fig. 324b omitted, the act is hardly defensible--not any more so than "See?" would be after fig. 318.

Again, authors who give 324a and "Behold!" fail to tell their readers whether Bhaskara's proof was geometric or algebraic. Why this silence on so essential a point? For, if algebraic, the fig. 324a is enough as the next two proofs show. I now quote from Beman and Smith: "The inside square is evidently $(b - a)^2$, and each of the four triangles is $\frac{1}{2}ab$; $\therefore h^2 - 4 \times \frac{1}{2}ab = (b - a)^2$, whence $h^2 = a^2 + b^2$."

It is conjectured that Pythagoras had discovered it independently, as also did Wallis, an English Mathematician, in the 17th century, and so reported; also Miss Coolidge, the blind girl, a few years ago: see proof Thirty-Two, fig. 133.

Two Hundred Twenty-Six

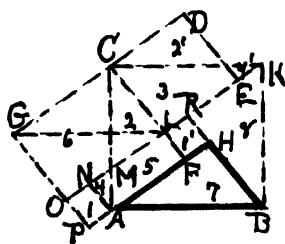


Fig. 325

In fig. 325, it is obvious that tri's 7 + 8 = rect. GL. Then it is easily seen, from congruent parts, that: sq. upon AB = sq. upon BH + sq. upon AH. $\therefore h^2 = a^2 + b^2$.

a. Devised by R. A. Bell, Cleveland, O., July 4, 1918. He submitted three more of same type.

Two Hundred Twenty-Seven

In fig. 326, $FG' = FH' = AB = h$, $DG' = EF = FN = OH' = BH = a$, and $DM' = EH' = G'N = FO = AH = b$.

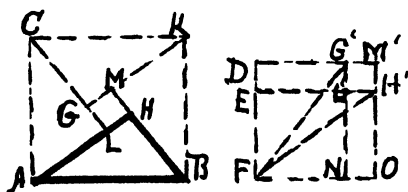


Fig. 326

$= a^2 + b^2$. \therefore sq. upon AB = sq. upon BH + sq. upon AH.

- a. Devised by author, Jan. 5, 1934.
- b. See Versluys, p. 69, fig. 73.

Two Hundred Twenty-Eight

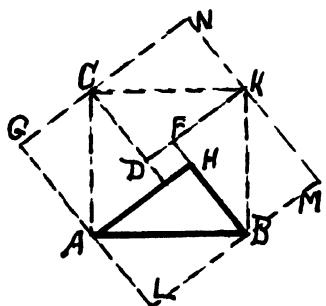


Fig. 327

Draw AL and BL par. resp'ly to BH and AH, and complete the sq. LN. $ABKC = h^2 = (b + a)^2 - 2ab$; but $ABKC = (b - a)^2 + 2ab$. $\therefore 2h^2 = 2a^2 + 2b^2$, or $h^2 = a^2 + b^2$. \therefore sq. upon AB = sq. upon BH + sq. upon AH.

a. See Versluys, p. 72, fig. 78, attributed to Saunderson (1682-1739), and came probably from the Hindu Mathematician Bhaskara.

Two Hundred Twenty-Nine

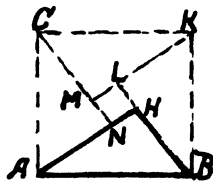


Fig. 328

In fig. 328, draw CN par. to BH, KM par. to AH, and extend BH to L.

$$\begin{aligned} \text{Sq. AK} &= 4 \frac{\text{HB} \times \text{HA}}{2} + \text{sq. MH} \\ &= 2\text{HB} \times \text{HA} + (\text{AH} - \text{BH})^2 = 2\text{HB} \times \text{HA} \\ &+ \text{HA}^2 - 2\text{HB} \times \text{HA} + \text{HB}^2 = \text{HB}^2 + \text{HA}^2. \end{aligned}$$

\therefore sq. upon AB = sq. upon BH + sq. upon AH.

a. See Olney's Geom., Part III, 1872, p. 250, 1st method; Jour. of Ed'n, Vol. XXV, 1887, p. 404, fig. IV, and also fig. VI; Jour. of Ed'n, Vol. XXVII, 1888, p. 327, 20th proof, by R. E. Binford, of Independence, Texas; Edwards' Geom., 1895, p. 155, fig. (3); Am. Math. Mo., Vol. VI, 1899, p. 69, proof XCII; Sci. Am. Sup., Vol. 70, p. 359, Dec. 3, 1910, fig. 1; Versluys, p. 68, fig. 72; Dr. Leitzmann's work, 1930, p. 22, fig. 26; Fourrey, p. 22, fig. a, as given by Bhaskara 12th century A.D. in Vija Ganita. For an algebraic proof see fig. 32, proof No. 34, under Algebraic Proofs.

b. A study of the many proofs by Arthur R. Colburn, LL.M., of Dist. of Columbia Bar, establishes the thesis, so often reiterated in this work, that figures may take any form and position so long as they include triangles whose sides bear a rational algebraic relation to the sides of the given triangle, or whose dissected areas are so related, through equivalency that $h^2 = a^2 + b^2$ results.

(B)--Proofs based upon a triangle through the calculations and comparisons of equivalent areas.

Two Hundred Thirty



Fig. 329

Draw HC perp. to AB. The three tri's ABH, BHC and HAC are similar.

We have three sim. tri's erected upon the three sides of tri. ABH whose hypotenuses are the three sides of tri. ABH.

Now since the area of tri. CBH + area of tri. CHA = area of tri. ABH, and since the areas of three sim. tri's are to each other as the squares of their corresponding sides, (in this case the three hypotenuses), therefore the area of each tri. is to the sq. of its hypotenuse as the areas of the other two tri's are to the sq's of their hypotenuses.

Now each sq. is = to the tri. on whose hypotenuse it is erected taken a certain number of times, this number being the same for all three. Therefore since the hypotenuses on which these sq's are erected are the sides of the tri. ABH, and since the sum of tri's erected on the legs is = to the tri. erected on the hypotenuse. \therefore the sum of the sq's erected on the legs = the sq. erected on the hypotenuse, $\therefore h^2 = a^2 + b^2$. Q.E.D.

a. Original, by Stanley Jashemski, age 19, of Youngstown, O., June 4, 1934, a young man of superior intellect.

b. If $m + n = p$ and $m : n : p = a^2 : b^2 : h^2$, then $m + n : a^2 + b^2 = n : b^2 = p : h^2$.

$\therefore \frac{m+n}{p} = \frac{a^2 + b^2}{h^2}$, or $1 = \frac{a^2 + b^2}{h^2}$. $\therefore h^2 = a^2 + b^2$. This algebraic proof given by E. S. Loomis.

Two Hundred Thirty-One

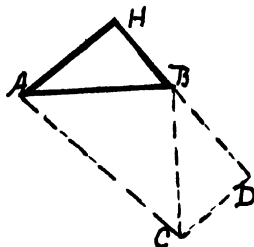


Fig. 330

In fig. 330, extend HB to D making $BD = AH$, through D draw DC par. to AH and equal to BH, and draw CB and CA.

Area of trap. CDHA = area of ACB + 2 area of ABH.

$\therefore \frac{1}{2}(AH + CD)HD = \frac{1}{2}AB^2 + 2 \times \frac{1}{2}AH \times HB$ or $(AH + HB)^2 = AB^2 + 2AH \times HB$, whence $AB^2 = BH^2 + AH^2$.

\therefore sq. upon AB = sq. upon BH + sq. upon AH. $\therefore h^2 = a^2 + b^2$.

a. This is the "Garfield Demonstration,"--hit upon by the General in a mathematical discussion with other M.C.'s about 1876. See Jour. of Ed'n, Vol. III, 1876, p. 161; The Math. Magazine, Vol. I, 1882, p. 7; The School Visitor, Vol. IX, 1888, p. 5, proof III; Hopkins' Plane Geom., 1891, p. 91, fig. VII; Edwards' Geom., 1895, p. 156, fig. (11); Heath's Math. Monographs, No. 1, 1900, p. 25,

proof X; Fourrey, p. 95; School Visitor, Vol. 20, p. 167; Dr. Leitzmann, p. 23, fig. 28a, and also fig. 28b for a variation.

b. For extension of any triangle, see V. Jelinek, Casopis, 28 (1899) 79--; Fsch. Math. (1899) 456.

c. See No. 219, fig. 318.

Two Hundred Thirty-Two



Fig. 331

By geometry, (see Wentworth's Revised Ed'n, 1895, p. 161, Prop'n XIX), we have $AH^2 + HB^2 = 2HM^2 + 2AM^2$. But in a rt. tri. $HM = AM$. So $b^2 + a^2 = 2AM^2 + 2AM^2 = 4AM^2 = 4\left(\frac{AB}{2}\right)^2 = AB^2 = h^2$. $\therefore h^2 = a^2 + b^2$.

a. See Versluys, p. 89, fig. 100, as given by Kruger, 1746.

Two Hundred Thirty-Three

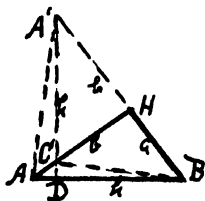


Fig. 332

Given rt. tri. ABH. Extend BH to A' making $HA' = HA$. Drop A'D perp. to AB intersecting AH at C. Draw AA' and CB.

Since angle ACD = angle HCA', then angle CA'H = angle BAH. Therefore tri's CHA' and BHA are equal. Therefore $HC = HB$.

$$\begin{aligned} \text{Quad. ACBA}' &= (\text{tri. CAA}' \\ &= \text{tri. CAB}) + \text{tri. BHC} + \text{CHA}' = \frac{h(\text{AD})}{2} \\ + \frac{h(\text{DB})}{2} &= \frac{h(\text{AD} + \text{BD})}{2} = \frac{h^2}{2} = \frac{a^2}{2} + \frac{b^2}{2} \quad \therefore h^2 = a^2 + b^2. \end{aligned}$$

a. See Dr. W. Leitzmann's work, p. 23, fig. 27, 1930, 3rd edition, credited to C. Hawkins, of Eng., who discovered it in 1909.

b. See its algebraic proof Fifty, fig. 48. The above proof is truly algebraic through equal areas. The author.

Two Hundred Thirty-Four

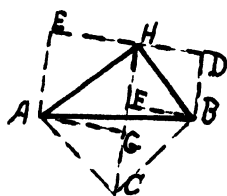


Fig. 333

Let C, D and E be the centers of the sq's on AB, BH and HA. Then angle BHD = 45° , also angle EHA. \therefore line ED through H is a st. line. Since angle AHB = angle BCA the quad. is inscriptible in a circle whose center is the middle pt. of AB, the angle CHB = angle BHD = 45° . \therefore CH is par. to BD. \therefore angle CHD = angle HDB = 90° . Draw

AG and BF perp. to CH. Since tri's AGC and CFB are congruent, CG = FB = DB and HG = AG = AE, then CH = EA + BD.

Now area of ACBH = $\frac{HC}{2}(AG + FB) = \frac{HC}{2} \times ED$
 = area of ABDE. From each take away tri. ABH, we get tri. ACB = tri. BHD + tri. HEA. 4 times this eq'n gives sq. upon AB = sq. upon HB + sq. upon HA. $\therefore h^2 = a^2 + b^2$.

a. See Fourrey, p. 78, as given by M. Piton-Bressant; Versluys, p. 90, fig. 103, taken from Van Piton-Bressant, per Fourrey, 1907.

b. See algebraic proof No. 67, fig. 66.

Two Hundred Thirty-Five

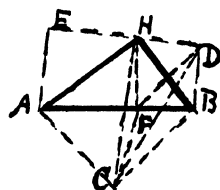


Fig. 334

Fig. 333 and 334 are same in outline. Draw HF perp. to AB, and draw DC, DF and FC. As in proof, fig. 333, HC is a st. line par. to BD. Then tri. BDH = tri. BDC. ---(1) As quad. HFBD is inscriptible in a circle whose center is the center of HB, then angle BFD = angle DFH = 45° = angle FBC. \therefore FD is par. to CB, whence tri. BCD

= tri. BCF. ---(2).

\therefore tri. BCF = tri. BDH. In like manner tri. ACF = tri. AHE. \therefore tri. ACB = tri. BDH + tri. HEA.
 --- (3). $4 \times (3)$ gives sq. upon AB = sq. upon HB + sq. upon HA. $\therefore h^2 = a^2 + b^2$.

a. See Fourrey, p. 79, as given by M. Piton-Bressant of Vitteneuve-Saint-Georges; also Versluys, p. 91, fig. 104.

b. See algebraic proof No. 66, fig. 67.

Two Hundred Thirty-Six

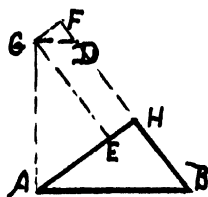


Fig. 335

In fig. 335, extend BH to F making HF = AH, erect AG perp. to AB making AG = AB, draw GE par. to HB and GD par. to AB. Since tri's ABH and GDF are similar, $GD = h(1 - a/b)$, and $FD = a(1 - a/b)$.

Area of fig. ABFG = area ABH + area AHFG = area ABDG + area GDF.
 $\therefore \frac{1}{2}ab + \frac{1}{2}b[b + (b - a)] = \frac{1}{2}h[h + h(1 - a/b)] + \frac{1}{2}a(b - a)(1 - a/b)$,

--- (1). Whence $h^2 = a^2 + b^2$. \therefore sq. upon AB = sq. upon BH + sq. upon AH.

a. This proof is due to J. G. Thompson, of Winchester, N.H.; see Jour. of Ed'n, Vol. XXVIII, 1888, p. 17, 28th proof; Heath's Math. Monographs, No. 2, p. 34, proof XXIII; Versluys, p. 78, fig. 87, by Rupert, 1900.

b. As there are possible several figures of above type, in each of which there will result two similar triangles, there are possible many different proofs, differing only in shape of figure. The next proof is one from the many.

Two Hundred Thirty-Seven

In fig. 336 produce HB to F making HF = HA, through A draw AC perp. to AB making AC = AB, draw CF, AG par. to HB, BE par. to AH, and BD perp. to AB.

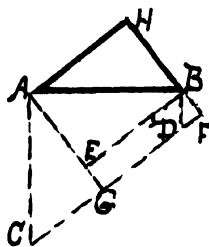


Fig. 336

Since tri's ABH and BDF are similar, we find that $DF = a(1 - a/b)$ and $BD = h(1 - a/b)$.

Area of trap. CFHA = 2 area ABH + area trap. AGFB = area ABH, + area trap. ACDB + area BDF.

Whence area ACG + area AGFB = area ACDB + area BDF or $\frac{1}{2}ab + \frac{1}{2}b[b + (b - a)] = \frac{1}{2}h[h + h(1 - a/b)] + \frac{1}{2}a(b - a)(1 - a/b)$.

This equation is equation (1) in the preceding solution, as it ought to be, since, if we draw BE par. to AH and consider only the figure below the line AB, calling the tri. ACG the given triangle, we have identically fig. 335, above.

\therefore sq. upon AB = sq. upon BH + sq. upon AH.
 $\therefore h^2 = a^2 + b^2$.

a. Original with the author, August, 1900.

See also Jour. of Ed'n, Vol. XXVIII, 1888, p. 17, 28th proof.

Two Hundred Thirty-Eight

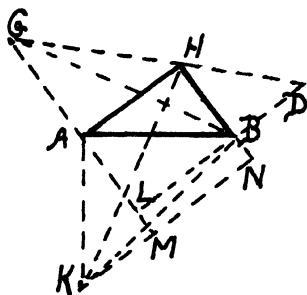


Fig. 337

In fig. 337, extend HB to N making $HN = AB$, draw KN, KH and BG, extend GA to M and draw BL par. to AH. Tri. KBA + tri. ABH = quad. BHAK = (tri. HAK = tri. GAB) + (tri. DGB = tri. HKB) = quad. ABDG = tri. HBD + tri. GAH + tri. ABH, whence tri. BAK = tri. HBD + tri. GAH.

\therefore sq. upon AB = sq. upon BH + sq. upon AH. $\therefore h^2 = a^2 + b^2$.

a. See Jury Wipper, 1880, p. 33, fig. 30, as found in the works of Joh. J. I. Hoffmann, Mayence, 1821; Fourrey, p. 75.

Two Hundred Thirty-Nine

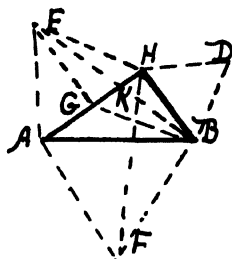


Fig. 338

In fig. 338, construct the three equilateral triangles upon the three sides of the given triangle ABH, and draw EB and FH, draw EG perp. to AH, and draw GB.

Since EG and HB are parallel, tri. EBH = tri. BEG = $\frac{1}{2}$ tri. ABH.
 \therefore tri. GBH = tri. HEG.

(1) Tri. HAF = tri. EAB
 = tri. EAK + (tri. BGA = $\frac{1}{2}$ tri. ABH)
 + (tri. BKG = tri. EKH) = tri. EAH
 + $\frac{1}{2}$ tri. ABH.

(2) In like manner, tri. BHF = tri. DHB + $\frac{1}{2}$ tri. ABH. (1) + (2) = (3) (tri. HAF + tri. BHF = tri. BAF + tri. ABH) = tri. EAH + tri. DHB + tri. ABH, whence tri. FBA = tri. EAH + tri. DHB.

But since areas of similar surfaces are to each other as the squares of their like dimensions, we have

tri. FBA : tri. DHB : tri. EAH = AB^2 : BH^2
 : AH^2 , whence tri. FBA : tri.
 DHB + tri. EAH = AB^2 : BH^2
 + AH^2 . But tri. FBA = tri.
 DAH + tri. EAH. $\therefore AB^2 = BH^2$
 + AH^2 .

\therefore sq. upon AB = sq.
 upon HD + sq. upon HA.

a. Devised by the
 author Sept. 18, 1900, for
 similar regular polygons
 other than squares.

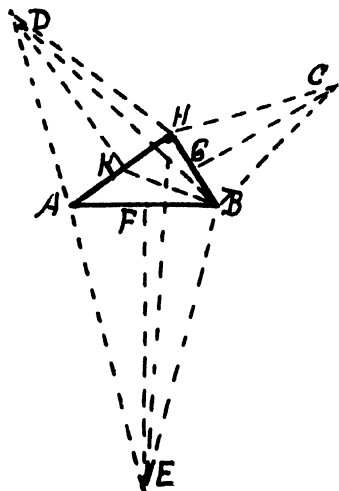


Fig. 339

Two Hundred Forty

In fig. 339, from the middle points of AB, BH and HA draw the three perp's FE, GC and KD, making $FE = 2AB$,

$GC = 2BH$ and $KD = 2HA$, complete the three isosceles tri's EBA , CHB and DAH , and draw EH , BK and DB .

Since these tri's are respectively equal to the three sq's upon AB , BH and HA , it remains to prove tri. $EBA = \text{tri. } CHB + \text{tri. } DAH$. The proof is same as that in fig. 338, hence proof for 339 is a variation of proof for 338.

a. Devised by the author, because of the figure, so as to get area of tri. $EBA = AB^2$, etc. $\therefore AB^2 = BH^2 + AH^2$.

\therefore sq. upon $AB = \text{sq. upon } BH + \text{sq. upon } AH$.
 $\therefore h^2 = a^2 + b^2$.

b. This proof is given by Joh. Hoffmann; see his solution in Wipper's Pythagoraische Lehrsatz, 1880, pp. 45-48.

See, also, Beman and Smith's New Plane and Solid Geometry, 1899, p. 105, ex. 207; Versluys, p. 59, fig. 63.

c. Since any polygon of three, four, five, or more sides, regular or irregular, can be transformed, (see Beman and Smith, p. 109), into an equivalent triangle, and it into an equivalent isosceles triangle whose base is the assumed base of the polygon, then is the sum of the areas of two such similar polygons, or semicircles, etc., constructed upon the two legs of any right triangle equal to the area of a similar polygon constructed upon the hypotenuse of said right triangle, if the sum of the two isosceles triangles so constructed, (be their altitudes what they may), is equal to the area of the similar isosceles triangle constructed upon the hypotenuse of the assumed triangle. Also see Dr. Leitzmann, (1930), p. 37, fig. 36 for semicircles.

d. See proof Two Hundred Forty-One for the establishment of above hypothesis.

Two Hundred Forty-One

Let tri's CBA , DHB and EAH be similar isosceles tri's upon the bases AB , BH and AH of the rt.

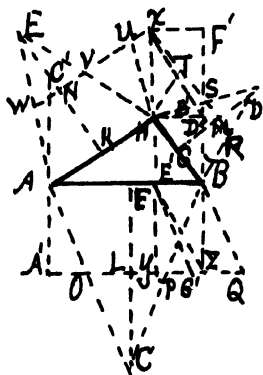


Fig. 340

tri. ABH, and CF, DG and EK their altitudes from their vertices C, D and E, and L, M and N the middle points of these altitudes.

Transform the tri's DHB, EAH and CBA into their respective paral's BRTH, AHUW and OQBA.

Produce RT and WU to X, and draw XHY. Through A and B draw A'AC' and ZBB' par. to XY. Through H draw HD' par. to OQ and complete the paral. HF'. Draw XD' and E'Z. Tri's E'YZ and XHD' are congruent, since YZ = HD' and respective angles are equal. \therefore EY = XH. Draw E'G' par. to BQ, and

paral. E'G'QB = paral. E'YZB = paral. XHD'F'; also paral. HBRT = paral. HBB'X. But paral. HBB'X is same as paral. XHBB' which = paral. XHD'F' = paral. E'YZB.

\therefore paral. E'G'QB = tri. DHB; in like manner paral. AOG'E' = tri. EAH. As paral. AA'ZB = paral. AOQB = tri. CBA, so tri. CBA = tri. DHB + tri. EAH. --- (1).

Since tri. CBA : tri. DHB : tri. EAH = $h^2 : a^2 : b^2$, tri. CBA : tri. DHB + tri. EAH = $h^2 : a^2 + b^2$. But tri. CAB = tri. DHB + tri. EAH. --- (1). $\therefore h^2 = a^2 + b^2$.

\therefore sq. upon AB = sq. upon BH + sq. upon AH.

Q.E.D.

a. Original with author. Formulated Oct. 28, 1933. The author has never seen, nor read about, nor heard of, a proof for $h^2 = a^2 + b^2$ based on isosceles triangles having any altitude or whose equal sides are unrelated to a, b, and h.

Two Hundred Forty-Two

Let X, Y and Z be three similar pentagons on sides h, a and b. Then, if $X = Y + Z$, $h^2 = a^2 + b^2$.

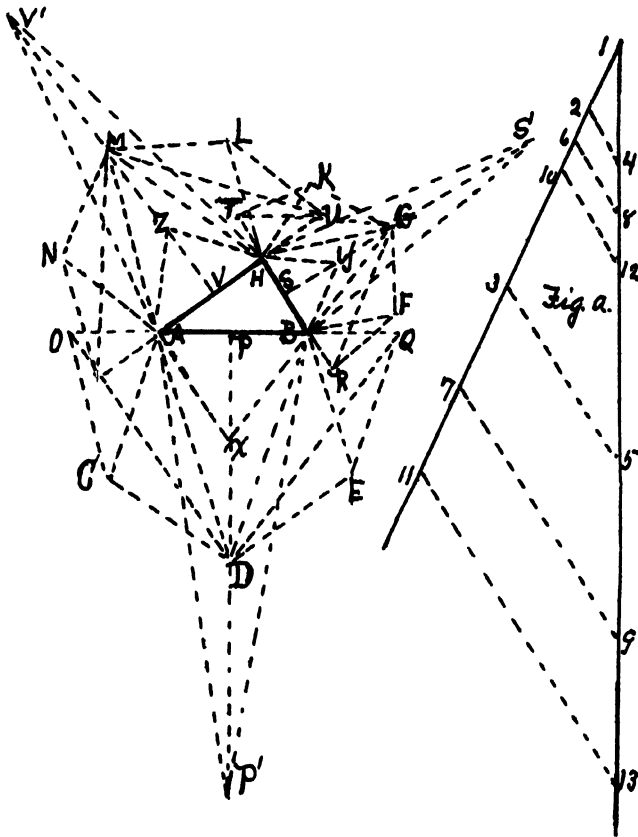


Fig. 341

Transform pentagon X, Y and Z into equivalent tri's DQO, RGT and UMW. Then, (by 4th proportional, Fig. a), transform said tri's into equivalent isosceles tri's P'BA, S'HB and V'AH.

Then proceed as in fig. 340. $\therefore h^2 = a^2 + b^2$.
 \therefore sq. upon AB = sq. upon BH + sq. upon AH. Q.E.D.

Or using the similar tri's XBH, YHB and ZAH, proving tri. XAB = tri. YHB + tri. ZAH, whence 5 tri. XBA = 5 tri. YHB + 5 tri. ZAH; etc.

By argument established under fig's 340 and 341, if regular polygons of any number of sides are const'd on the three sides of any rt. triangle, the sum of the two lesser = the greater, whence always $h^2 = a^2 + b^2$.

a. Devised by the author, Oct. 29, 1933.

b. In fig. a, 1-2 = HB; 2-3 = TR; 1-4 = GS; 4-5 = SS'; 1-B = AH; 6-7 = WU; 1-8 = MV; 8-9 = VV'; 1-10 = AB; 11-11 = OQ; 1-12 = PD; 12-13 = P'P.

Two Hundred Forty-Three

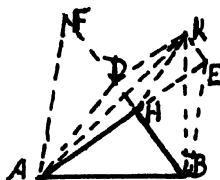


Fig. 342

In fig. 342, produce AH to E making HE = HB, produce BH to F making HF = HA, draw RB perp. to AB making BK = BA, KD. par. to AH, and draw EB, KH, KA, AD and AF. BD = AB and KD = HB.

Area of tri. ABK = (area of tri. KHB = area of tri. EHB) + (area of tri. AHK = area of tri. AHD) + (area of ABH = area of ADF).

\therefore area of ABK = area of tri. EHB + area of tri. AHF. \therefore sq. upon AB = sq. upon BH + sq. upon AH. $\therefore h^2 = a^2 + b^2$.

a. See Edwards' Geom., 1895, p. 158, fig. (20).

Two Hundred Forty-Four



Fig. 343

In fig. 343, take AD = AH, draw ED perp. to AB, and draw AE. Tri. ABH and BED are similar, whence DE = AH \times BD \div HB. But DB = AB - AH.

Area of tri. ABH = $\frac{1}{2}$ AH \times BH

$$\begin{aligned}
 &= 2 \frac{AD \times ED}{2} + \frac{1}{2}ED \times DB = AD \times ED \\
 + \frac{1}{2}ED \times DB &= \frac{AH^2(AB - AH)}{BH} + \frac{1}{2} \frac{AH(NB - AH)^2}{BH} \quad \therefore BH^2 \\
 &= 2AH \times AB - 2AH^2 + AB^2 + AH^2 - 2AH \times AB. \quad \therefore AB^2 \\
 &= BH^2 + AH^2.
 \end{aligned}$$

\therefore sq. upon AB = sq. upon BH + sq. upon AH.
 $\therefore h^2 = a^2 + b^2$.

a. See Am. Math. Mo., Vol. VI, 1899, p. 70, proof XCV.

b. See proof Five, fig. 5, under I, Algebraic Proofs, for an algebraic proof.

Two Hundred Forty-Five

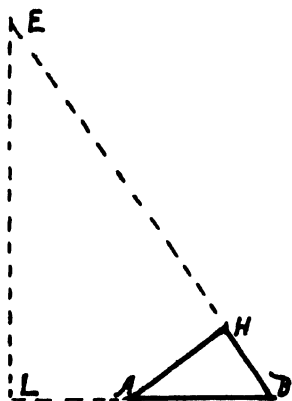


Fig. 344

In fig. 344, produce BA to L making AL = AH, at L draw EL perp. to AB, and produce BH to E. The tri's ABH and EBL are similar.

$$\begin{aligned} \text{Area of tri. ABH} &= \frac{1}{2}AH \times BH \\ &= \frac{1}{2}LE \times LB - LE \times LA \\ &= \frac{1}{2} \frac{AH(AH + AB)^2}{BH} - \frac{AH^2(AH + AB)}{BH}, \end{aligned}$$

whence $AB^2 = BH^2 + AH^2$.

\therefore sq. upon AB = sq. upon BH + sq. upon AH. $\therefore h^2 = a^2 + b^2$.

a. See Am. Math. Mo., Vol. VI, 1899, p. 70, proof XCVI.

b. This and the preceding proof are the converse of each other. The two proofs teach that if two triangles are similar and so related that the area of either triangle may be expressed principally in terms of the sides of the other, then either triangle may be taken as the principal triangle, giving, of course, as many solutions as it is possible to express the area of either in terms of the sides of the other.

Two Hundred Forty-Six

In fig. 345, produce HA and HB and describe the arc of a circle tang. to HX, AB and HY. From O,

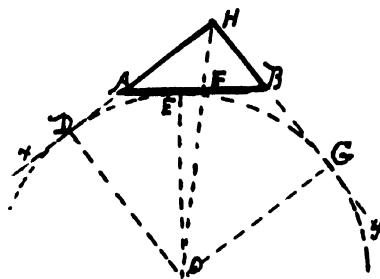


Fig. 345

$$= a^2 + b^2.$$

\therefore sq. upon AB = sq. upon BH + sq. upon AH.

$$\therefore h^2 = a^2 + b^2.$$

a. This proof is original with Prof. B. F. Yanney, Wooster University, O. See Am. Math. Mo., Vol. VI, 1899, p. 70, XCVII.

Two Hundred Forty-Seven

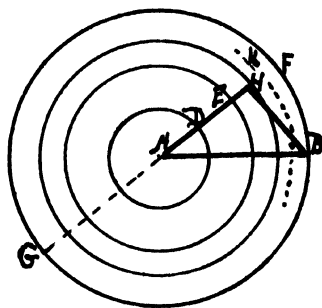


Fig. 346

In fig. 346, let $AE = BH$. Since the area of a circle is πr^2 , if it can be proven that the circle whose radius is AB = the circle whose radius is AH + the circle whose radius is AE , the truth sought is established.

It is evident, if the triangle ABH revolves in the plane of the paper about A as a center, that the area of the circle generated by AB will equal the area of the

circle generated by AH plus the area of the annulus generated by HF .

Hence it must be shown, if possible, that the area of the annulus is equal to the area of the circle whose radius is AE .

its center, draw to points of tangency, OG , OE and OD , and draw OH .

Area of sq. DG

$$= r^2 = \frac{1}{2}ab + (2 \frac{BE \times r}{2} + 2 \frac{AE \times r}{2}) = \frac{1}{2}ab + hr.$$

But since $2r = h + a + b$,

$$\therefore r = \frac{1}{2}(h + a + b).$$

$$\therefore \frac{1}{4}(h + a + b)^2 = \frac{1}{2}ab + h(h + a + b), \text{ whence } h^2$$

Let $AB = h = AF$, $AH = b$, $BH = a$, $AD = \frac{1}{2}BH = r$, $HK = KF$, and $AK = mr$, whence $GH = h + b$, $AK = \frac{h + b}{2} = mr$, $HF = h - b$, $HK = KF = \frac{h - b}{2}$.

Now $(GH = h + b) : (BH = 2r) = (BH = 2r) : (HF = h - b)$. --- (1)

whence $h = \sqrt{b^2 + 4r^2}$ and $b = \sqrt{h^2 - 4r^2}$. $\therefore \frac{h + b}{2} = \frac{\sqrt{b^2 + 4r^2} + b}{2} = mr$, whence $b = r(m - \frac{1}{m})$, and $\frac{h + b}{2} = \frac{h + \sqrt{h^2 - 4r^2}}{2} = mr$, whence $h = r(m + \frac{1}{m})$. $\therefore \frac{a - b}{2} = \frac{r(m + \frac{1}{m}) - r(m - \frac{1}{m})}{2} = \frac{r}{m} = HK$. Now since $(AD = r)$

$: (AK = mr) = (HK = \frac{r}{m}) : (AD = r)$. --- (2)

$\therefore AD : AK = HF : AE$, or $2\pi AD : 2\pi AK = HF : AE$,

$\therefore 2\pi AK \times HF = 2\pi AD \times AE$, or $2\pi (\frac{h + b}{2})HF = \pi AE \times AE$.

But the area of the annulus equals $\frac{1}{2}$ the sum of the circumferences where radii are h and b times the width of the annulus or HF .

\therefore the area of the annulus $HF =$ the area of the circle where radius is HB .

\therefore the area of the circle with radius $AB =$ the area of the circle with radius $AH +$ area of the annulus.

$$\therefore \pi h^2 = \pi a^2 + \pi b^2.$$

\therefore sq. upon $AB =$ sq. upon $BH +$ sq. upon AH .

$$\therefore h^2 = a^2 + b^2.$$

a. See Am. Math. Mo., Vol. I, 1894, p. 223, the proof by Andrew Ingraham, President of the Swain Free School, New Bedford, Mass.

b. This proof, like that of proof Two Hundred Fifteen, fig. 313 proves too much, since both equations (1) and (2) imply the truth sought. The author, Professor Ingraham, does not show his readers how he determined that $HK = \frac{r}{m}$, hence the implication is hidden; in (1) we have directly $h^2 - b^2 = (4r^2 = a^2)$.

Having begged the question in both equations, (1) and (2), Professor Ingraham has, no doubt, unconsciously, fallen under the formal fallacy of *petitio principii*.

c. From the preceding array of proofs it is evident that the algebraic and geometric proofs of this most important truth are as unlimited in number as are the ingenious resources and ideas of the mathematical investigator.

NO TRIGONOMETRIC PROOFS

Facing forward the thoughtful reader may raise the question: Are there any proofs based upon the science of trigonometry or analytical geometry?

There are no trigonometric proofs, because all the fundamental formulae of trigonometry are themselves based upon the truth of the Pythagorean Theorem; because of this theorem we say $\sin^2 A + \cos^2 A = 1$, etc. Trigonometry *is* because the Pythagorean Theorem *is*.

Therefore the so-styled Trigonometric Proof, given by J. Versluys, in his Book, *Zes en Negentig Bewijzen*, 1914 (a collection of 96 proofs), p. 94, proof 95, is not a proof since it employs the formula $\sin^2 A + \cos^2 A = 1$.

As Descartes made the Pythagorean theorem the basis of his method of analytical geometry, no independent proof can here appear. Analytical Geometry is Euclidian Geometry treated algebraically and hence involves all principles already established.

Therefore in analytical geometry all relations concerning the sides of a right-angled triangle imply or rest directly upon the Pythagorean theorem as is shown in the equation, viz., $x^2 + y^2 = r^2$.

And The Calculus being but an algebraic investigation of geometric variables by the method of limits it accepts the truth of geometry as established, and therefore furnishes no new proof, other than that, if squares be constructed upon the three



RENÉ DESCARTES
1596-1650

sides of a variable oblique triangle, as any angle of the three approaches a right angle the square on the side opposite approaches in area the sum of the squares upon the other two sides.

But not so with quaternions, or vector analysis. It is a mathematical science which introduces a new concept not employed in any of the mathematical sciences mentioned heretofore,--the concept of direction.

And by means of this new concept the complex demonstrations of old truths are wonderfully simplified, or new ways of reaching the same truth are developed.

III. QUATERNIONIC PROOFS

We here give four quaternionic proofs of the Pythagorean Proposition. Other proofs are possible.

One

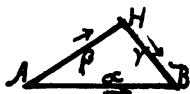


Fig. 347

In fig. 347 designate the sides as to distance and direction by a , b and g (in place of the Greek alpha α , beta β and gamma γ). Now, by the principle of direction, $a = b + g$; also since the angle at H is a right angle, $2sbg = 0$ (s signifies Scalar).

See Hardy, 1881, p. 6).

(1) $a + b = g$ (1)² = (2) $a^2 = b^2 + 2sbg + g^2$.
 (2) reduced = (3). $\therefore a^2 = b^2 + g^2$, considered as lengths. \therefore sq. upon $AB =$ sq. upon $BH +$ sq. upon AH .
 $\therefore h^2 = a^2 + b^2$. Q.E.D.

a. See Hardy's Elements of Quaternions, 1881, p. 82, art. 54, 1; also Jour. of Education, Vol. XXVII, 1888, p. 327, Twenty-Second Proof; Versluys, p. 95, fig. 108.

Two

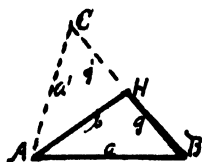


Fig. 348

In fig. 348, extend BH to C making $HC = HB$ and draw AC . As vectors $AB = AH + HB$, or $A = B + G$ (1). Also $AC = AH + HC$, or $A = B - G$ (2).

Squaring (1) and (2) and adding, we have $A^2 + A^2 = 2B^2 + 2G^2$. Or as lengths, $AB^2 + AC^2 = 2AH^2 + 2AB^2$. But $AB = AC$.

$$\therefore AB^2 = AH^2 + HB^2.$$

\therefore sq. upon $AB =$ sq. upon $AH +$ sq. upon HB .
 $\therefore h^2 = a^2 + b^2$.

a. This is James A. Calderhead's solution. See Am. Math. Mo., Vol. VI, 1899, p. 71, proof XCIX.

Three

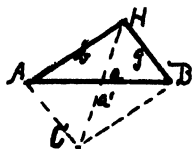


Fig. 349

In fig. 349, complete the rect. HC and draw HC. As vectors $AB = AH + HB$, or $a = b + g$ (1). $HC = HA + AC$, or $a = -b + g$ (2).

Squaring (1) and (2) and adding, gives $A^2 + A'^2 = 2B^2 + 2G^2$. Or considered as lines, $AB^2 + HC^2 = 2AH^2 + 2HB^2$. But $HC = AB$.

$$\therefore AB^2 = AH^2 + HB^2.$$

\therefore sq. upon AB = sq. upon AH^2 + sq. upon HB^2 .

$$\therefore h^2 = a^2 + b^2.$$

a. Another of James A. Calderhead's solutions. See Am. Math. Mo., Vol. VI, 1899, p. 71, proof C; Versluys, p. 95, fig. 108.

Four

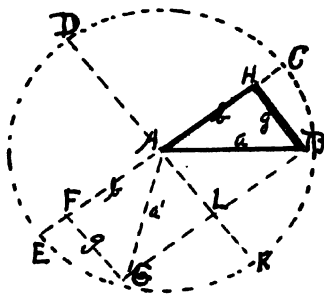


Fig. 350

In fig. 350, the construction is evident, as angle $GAK = -\text{angle } BAK$. The radius being unity, LG and LB are sines of GAK and BAK.

As vectors, $AB = AH + HB$, or $a = b + g$ (1). Also $AG = AF + FG$ or $a' = -b + g$ (2). Squaring (1) and (2) and adding gives $a^2 + a'^2 = 2b^2 + 2g^2$. Or considering the vectors as distances, $AB^2 + AG^2 = 2AH^2 + 2HB^2$, or $AB^2 = AH^2 + HB^2$.

\therefore sq. upon AB = sq. upon AH + sq. upon BH .

$$\therefore h^2 = a^2 + b^2.$$

a. Original with the author, August, 1900.

b. Other solutions from the trigonometric right line function figure (see Schuyler's Trigonometry, 1873, p. 78, art 85) are easily devised through vector analysis.

IV. DYNAMIC PROOFS

The Science of Dynamics, since 1910, is a claimant for a place as to a few proofs of the Pythagorean Theorem.

A dynamic proof employing the principle of moment of a couple appears as proof 96, on p. 95, in J. Versluys' (1914) collection of proofs.

It is as follows:

One

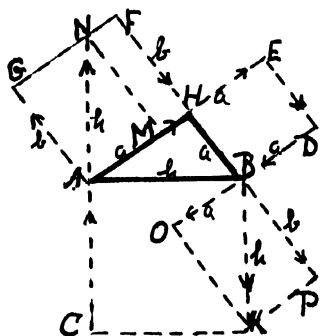


Fig. 351

In compliance with the theory of the moment of couple, in mechanic (see "Mechanics for Beginners, Part I," 1891, by Rev. J. B. Locke, p. 105), the moment of the sum of two conjoined couples in the same flat plane is the same as the sum of the moments of the two couples, from which it follows that $h^2 = a^2 + b^2$.

If FH and AG represent two equal powers they form a couple whereof the moment equals $FH \times AH$, or b^2 .

If HE and DB represent two other equal powers they form a couple whereof the moment equals $DB \times HB$ or a^2 .

To find the moment of the two couples join the two powers AG and HE, also the two powers DB and FH. To join the powers AG and HE, take $AM = HE$. The diagonal AN of the parallelogram of the two powers AG and AM is equal to CA. To join the powers FH and DB, take $BO = DB$. The diagonal BK of the parallelogram of the two powers ($FH = BP$) and BO, is the second

component of the resultant couple whose moment is $CH \times BK$, or h^2 . Thus we have $h^2 = a^2 + b^2$.

a. See J. Versluys, p. 95, fig. 108. He (Versluys) says: I found the above proof in 1877, by considering the method of the theory of the principle of mechanics and to the present (1914) I have never met with a like proof anywhere.

In Science, New Series, Oct. 7, 1910, Vol. 32, pp. 863-4, Professor Edwin F. Northrup, Palmer Physical Laboratory, Princeton, N.J., through equilibrium of forces, establishes the formula $h^2 = a^2 + b^2$.

In Vol. 33, p. 457, Mr. Mayo D. Hersey, of the U.S. Bureau of Standards, Washington, D.C., says that, if we admit Professor Northrup's proof, then the same result may be established by a much simpler course of reasoning based on certain simple dynamic laws.

Then in Vol. 34, pp. 181-2, Mr. Alexander MacFarlane, of Chatham, Ontario, Canada, comes to the support of Professor Northrup, and then gives two very fine dynamic proofs through the use of trigonometric functions and quaternionic laws.

Having obtained permission from the editor of Science, Mr. J. McK. Cattell, on February 18, 1926, to make use of these proofs found in said volumes 32, 33 and 34, of Science, they now follow.

Iwq

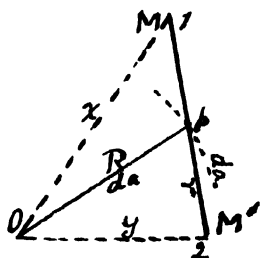


Fig. 352

In fig. 352, 0-p is a rod without mass which can be revolved in the plane of the paper about 0 as a center. 1-2 is another such rod in the plane of the paper of which p is its middle point. Concentrated at each end of the rod 1-2 are equal masses m and m' each distant r from p.

Let R equal the distance 0-p, $X = 0-1$, $y = 0-2$. When the

system revolves about 0 as a center, the point p will have a linear velocity, $r = ds/dt = da/dt = RW$, where ds is the element of the arc described in time dt, da is the differential angle through which 0-p turns, and W is the angular velocity.

1. Assume the rod 1-2 free to turn on p as a center. Since m at 1 and m' at 2 are equal and equally distant from p, p is the center of mass. Under these conditions $E' = \frac{1}{2}(2m)V^2 = mR^2W^2$. --- (1)

2. Conceive rod, 1-2, to become rigorously attached at p. Then as 0-p revolves about 0 with angular velocity W, 1-2 also revolves about p with like angular velocity. By making attachment at p rigid the system is forced to take on an additional kinetic energy, which can be only that, which is a result of the additional motion now possessed by m at 1 and by m' at 2, in virtue of their rotation about p as a center. This added kinetic energy is $E'' = \frac{1}{2}(2m)r^2W^2 = mr^2W^2$. --- (2) Hence total kinetic energy is $E = E' + E'' = mW^2(R^2 + r^2)$. --- (3)

3. With the attachment still rigid at p, the kinetic energy of m at 1 is, plainly, $E'_0 = \frac{1}{2}mx^2W^2$. --- (4) Likewise $E''_0 = \frac{1}{2}my^2W^2$. --- (5)

\therefore the total kinetic energy must be $E = E'_0 + E''_0 = \frac{1}{2}mW^2(x^2 + y^2)$. --- (6)

\therefore (3) = (6), or $\frac{1}{2}(x^2 + y^2) = R^2 + r^2$. --- (7)

In (7) we have a geometric relation of some interest, but in a particular case when $x = y$, that is, when line 1-2 is perpendicular to line 0-p, we have as a result $x^2 = R^2 + r^2$. --- (8)

\therefore sq. upon hypotenuse = sum of squares upon the two legs of a right triangle.

Then in Vol. 33, p. 457, on March 24, 1911, Mr. Mayo D. Hersey says: "while Mr. R. F. Deimal holds that equation (7) above expresses a geometric fact--I am tempted to say 'accident'--which textbooks raise to the dignity of a theorem." He further says: "Why not let it be a simple one? For instance, if the force F whose rectangular components are x and y, acts upon a particle of mass m until that v^2 must be

positive; consequently, to hold that the square of a simple vector is negative is to contradict the established conventions of mathematical analysis.

The quaternionist tries to get out by saying that after all v is not a velocity having direction, but merely a speed. To this I reply that $E = \int mv dv = \frac{1}{2}mv^2$, and that these expressions v and dv are both vectors having directions which are different.

Recently (in the Bulletin of the Quaternion Association) I have been considering what may be called the generalization of the Pythagorean Theorem.

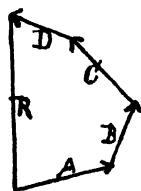


Fig. 353

Let A, B, C, D , etc., fig. 353, denote vectors having any direction in space, and let R denote the vector from the origin of A to the terminal of the last vector; then the generalization of the P.T. is $R^2 = A^2 + B^2 + C^2 + D^2$

+ $2(\cos AB + \cos AC + \cos AD) + 2(\cos BC + \cos BD) + 2(\cos CD) + \text{etc.}$, where $\cos AB$ denotes the rectangle formed by A and the projection of B parallel to A . The theorem of P. is limited to two vectors A and B which are at right angles to one another, giving $R^2 = A^2 + B^2$. The extension given in Euclid removes the condition of perpendicularity, giving $R^2 = A^2 + B^2 + \cos AB$.

Space geometry gives $R^2 = A^2 + B^2 + C^2$ when A, B, C are orthogonal, and $R^2 = A^2 + B^2 + C^2 + 2 \cos AB + 2 \cos AC + 2 \cos BC$ when that condition is removed.

Further, space-algebra gives a complementary theorem, never dreamed of by either Pythagoras or Euclid.

Let V denote in magnitude and direction the resultant of the directed areas enclosed between the broken lines $A + B + C + D$ and the resultant line R , and let $\sin AB$ denote in direction and magnitude the area enclosed between A and the projection of B which is perpendicular to A ; then the complementary theorem is $4V = 2(\sin AB + \sin AC + \sin AD + \quad) + 2(\sin BC + \sin BD + \quad) + 2(\sin CD + \quad) + \text{etc.}$

THE PYTHAGOREAN CURIOSITY

The following is reported to have been taken from a notebook of Mr. John Waterhouse, an engineer

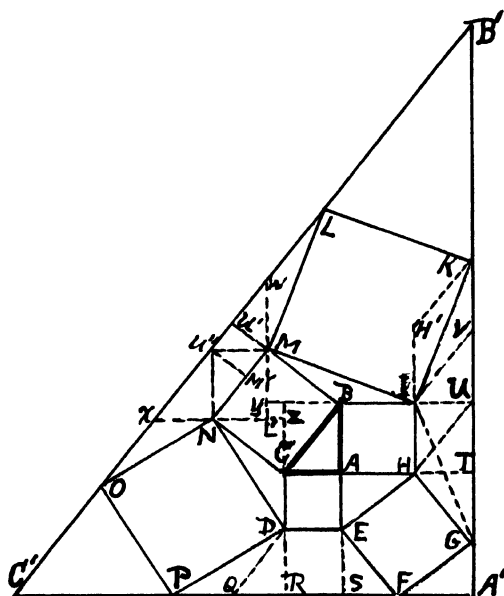


Fig. 354

of N.Y. City. It appeared in print, in a N.Y. paper, in July, 1899. Upon the sides of the right triangle, fig. 354, construct the squares AI, BN, and CE. Connect the points E and H, I and M, and N and D. Upon these lines construct the squares EG, MK and NP, and connect the points P and F, G and K, and L and O. The following truths are demonstrable.

1. Square BN = square CE + square AI. (Euclid).

2. Triangle HAE = triangle IBM = triangle DCN = triangle CAB, since HA = BI and EA = MY, EA = DC and HA = NZ, and HA = BA and EA = CA.

3. Lines HI and GK are parallel, for, since angle GHI = angle IBM, \therefore triangle HGI = triangle BMI, whence IG = IM = IK. Again extend HI to H' making IH' = IH, and draw H'K, whence triangle IHG = triangle IH'K, each having two sides and the included angle respectively equal. \therefore the distances from G and K to the line HH' are equal. \therefore the lines HI and GK are parallel. In like manner it may be shown that DE and PF, also MN and LO, are parallel.

4. $GK = 4HI$, for $HI = TU = GT = UV = VK$ (since VK is homologous to BI in the equal triangles VKI and BIM). In like manner it can be shown that $PF = 4DE$. That $LO = 4MN$ is proven as follows: triangles LWM and IVK are equal; therefore the homologous sides WM and VK are equal. Likewise OX and QD are equal each being equal to MN . Now in tri. WJX , MJ and $XN = NJ$; therefore M and N are the middle points of WJ and XJ ; therefore $WX = 2MN$; therefore $LO = 4MN$.

5. The three trapezoids $HIGK$, $DEPF$ and $MNLO$ are each equal to 5 times the triangle CAB . The 5 triangles composing the trapezoid $HIGK$ are each equal to the triangle CAB , each having the same base and altitude as triangle CAB . In like manner it may be shown that the trapezoid $DEPF$, so also the trapezoid $MNLO$, equals 5 times the triangle CAB .

6. The square MK + the square $NP = 5$ times the square EG or BN . For the square on $MI =$ the square on MY + the square on $YI + (2AB)^2 + AC^2 = 4AB^2 + AC^2$; and the square on ND + the square on NZ + the square $ZD = AB^2 + (2AC)^2 = AB^2 + 4AC^2$. Therefore the square MK + the square $NP = 5AB^2 + 5AC^2 = 5(AB^2 + AC^2) = 5BC^2 = 5$ times the square BN .

7. The bisector of the angle A' passes through the vertex A ; for $A'S = A'T$. But the bisector of the angle B' or C' , does not pass through the vertex B , or C . Otherwise BU would equal BU' , whence $NU'' + U''M$ would equal $NM + U''M'$; that is, the sum of the two legs of a right triangle would equal the hypotenuse + the perpendicular upon the hypotenuse from the right angle. But this is impossible. Therefore the bisector of the angle B' does not pass through the vertex B .

8. The square on $LO =$ the sum of the squares on PF and GK ; for $LO : PF : GK = BC : CA : AB$.

9. Etc., etc.

See Casey's Sequel to Euclid, 1900, Part I,

PYTHAGOREAN MAGIC SQUARES

One

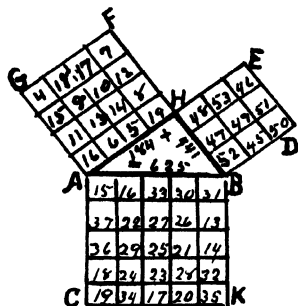


Fig. 355

Formulated by the author, July, 1900.

Two

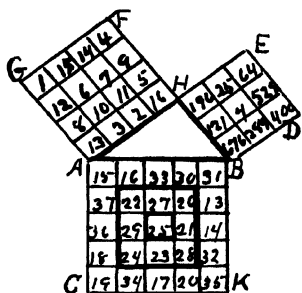


Fig. 356

The sum of any row, column or diagonal of the square AK is 125; hence the sum of all the numbers in the square is 625. The sum of any row, column or diagonal of square GH is 46, and of HD is 147; hence the sum of all the numbers in the square GH is 184, and in the square HD is 441. Therefore the magic square AK (625) = the magic square HD (441) + the magic square HG (184).

The square AK is composed of 3 magic squares, 5^2 , 15^2 and 25^2 . The square HD is a magic square each number of which is a square. The square HG is a magic square formed from the first 16 numbers. Furthermore, observe that the sum of the nine square numbers in the square HD equals 48^2 or 2304, a square number.

Formulated by the author, July, 1900.

Three

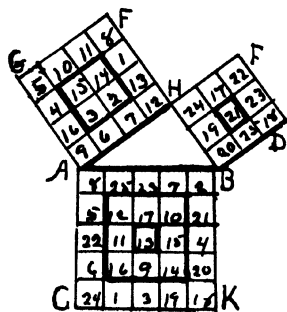


Fig. 357

The sum of all the numbers (AK = 325) = the sum of all the numbers in square (HD = 189) + the sum of all the numbers in square (HG + 136).

Square AK is made up of 13, $3 \times (3 \times 13)$, and $5 \times (5 \times 13)$; square HD is made up of 21, $3 \times (3 \times 21)$, and square HG is made up of 4×34 - each row, column and diagonal, and the sum of the four inner numbers.

Many other magic squares of this type giving 325, 189 and 136 for the sums of AK, HD and HG respectively may be formed.

This one was formed by Prof. Paul A. Towne, of West Edmeston, N.Y.

Four

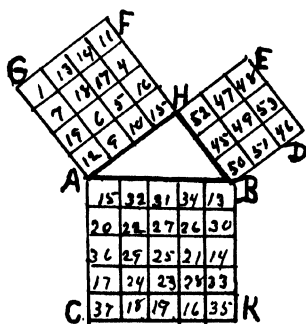


Fig. 358

The sum of numbers in sq. (AK = 625) = the sum of numbers in sq. (HD = 441) + the sum of numbers in sq. (HG = 184).

Sq. AK gives $1 \times (1 \times 25)$; $3 \times (3 \times 25)$; and $5 \times (5 \times 25)$, as elements; sq. HD gives $1 \times (1 \times 49)$; $3 \times (3 \times 49)$ as elements; and sq. HG gives 1×46 and 3×46 , as elements.

This one also was formed by Professor Towne, of West Edmeston, N.Y. Many of this

type may be formed. See fig. 355, above, for one of my own of this type.

Also see *Mathematical Essays and Recreations*, by Herman Schubert, in *The Open Court Publishing Co.*, Chicago, 1898, p. 39, for an extended theory of The Magic Square.

Five

Observe the following series:

The sum of the inner 4 numbers is $1^2 \times 202$; of the 16-square, $2^2 \times 202$; of the 36-square, $3^2 \times 202$; of the 64-square, $4^2 \times 202$; and of the 100-square, $5^2 \times 202$.

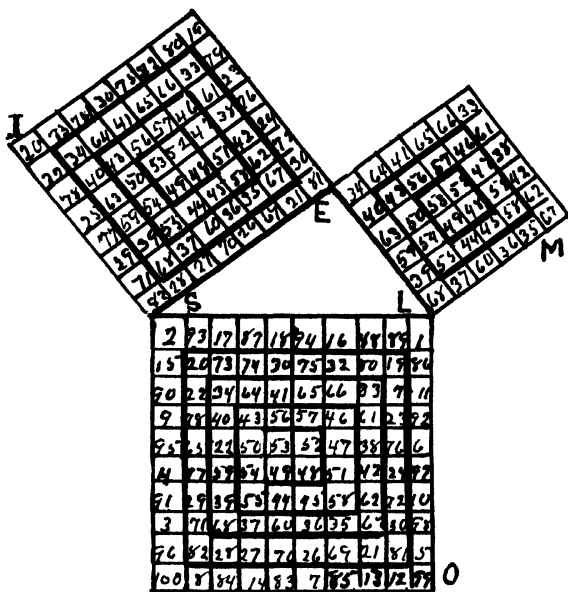


Fig. 359

"On the hypotenuse and legs of the right-angled triangle, ESL, are constructed the concentric magic squares of 100, 64, 36 and 16. The sum of the two numbers at the extremities of the diagonals, and

of all lines, horizontal and diagonal, and of the two numbers equally distant from the extremities, is 101. The sum of the numbers in the diagonals and lines of each of the four concentric magic squares is 101 multiplied by half the number of cells in boundary lines; that is, the summations are 101×2 ; 101×3 ; 101×4 ; 101×5 . The sum of the 4 central numbers is 101×2 .

\therefore the sum of the numbers in the square ($SO = 505 \times 10 = 5050$) = the sum of the numbers in the square ($EM = 303 \times 6 = 1818$) + the sum of the numbers in the square ($EI = 404 \times 8 = 3232$). $505^2 = 303^2 + 404^2$.

Notice that in the above diagram the concentric magic squares on the legs is identical with the central concentric magic squares on the hypotenuse." Professor Paul A. Towne, West Edmeston, N.Y.

An indefinite number of magic squares of this type are readily formed.

ADDENDA

The following proofs have come to me since June 23, 1939, the day on which I finished page 257 of this 2nd edition.

Two Hundred Forty-Eight

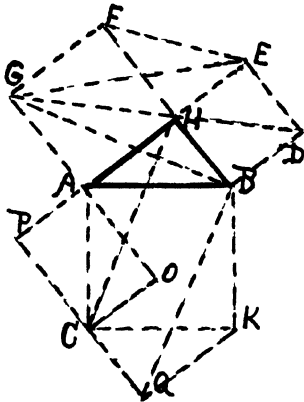


Fig. 360

In fig. 360, extend HA to P making $AP = HB$, and through P draw PQ par. to HB, making $CQ = HB$; extend GA to O, making $AO = AG$; draw FE, GE, GD, GB, CO, QK, HC and BQ.

Since, obvious, tri. $KCQ = \text{tri. } ABC = \text{tri. } FEH$, and since area of tri. $BDG = \frac{1}{2}BD \times FB$, then area of quad. $GEDE = BD \times (FB = HP) = \text{area of paral. } BHCQ = \text{sq. } BE + 2 \text{ tri. } BHG$, then it follows that:

Sq. AK = hexagon

$ACQKBH - 2 \text{ tri. } ABH = (\text{tri. } ACH = \text{tri. } GAB) + (\text{paral. } BHCQ$

$= \text{sq. } BE + 2 \text{ tri. } BHG) + (\text{tri. } QKB = \text{tri. } GFE) = \text{hexagon } GABDEF - 2 \text{ tri. } ABH = \text{sq. } AF + \text{sq. } BE$. Therefore sq. upon AB = sq. upon HB + sq. upon HA. $\therefore h^2 = a^2 + b^2$. Q.E.D.

a. Devised, demonstrated with geometric reason for each step, and submitted to me June 29, 1939. Approved and here recorded July 2, 1939, after ms. for 2nd edition was completed.

b. Its place, as to type and figure, is next after Proof Sixty-Nine, p. 141, of this edition.

c. This proof is an Original, his No. VII, by Joseph Zelson, of West Phila. High School, Phila., Pa.

Two Hundred Forty-Nine

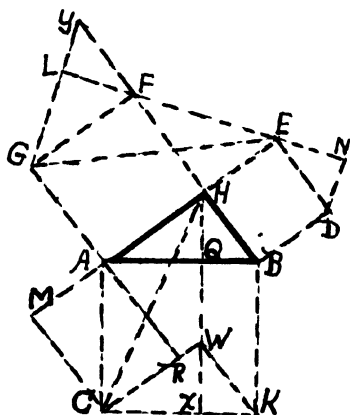


Fig. 361

It is easily proven that: tri. GFY = tri. FHE = tri. ABH = tri. CMA = tri. ARC = tri. CWK; also that tri. GAE = tri. CMH; tri. LGE = tri. CXH; tri. FYL = tri. EDN = tri. WKY; tri. GFY = tri. GFL + tri. NED; that paral. BHWK = sq. HD. Then it follows that sq. AK = pentagon MCKBH - 2 tri. ABH = (tri. MCH = tri. GAE) + (tri. CXH = tri. LGE) + [(quad. BH XK = pent. HBDNE) = sq. BE + (tri. EDN = tri. WKX)] = hexagon GAHBDNL - 2 tri. ABH = sq. AF + sq. BE.

\therefore sq. upon AB = sq. upon HB + sq. upon HA.
 $\therefore h^2 = a^2 + b^2$.

a. This proof, with figure, devised by Master Joseph Zelson and submitted June 29, 1939, and here recorded July 2, 1939.

b. Its place is next after No. 247, on p. 185 above.

Two Hundred Fifty

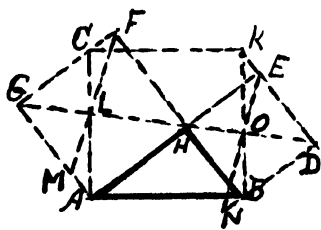


Fig. 362

In fig. 362, draw GD. At A and B erect perp's AC and BK to AB. Through L and O draw FM, and EN = FM = AB. Extend DE to K.

It is obvious that: quad. GMLC = quad. OBDE; quad. OBDE + (tri. LMA = tri. OKE) = tri. ABH; tri. BDK = tri. EDN = tri. ABH = tri. EFH = tri. MFG = tri. CAG.

Then it follows that: sq. GH + sq. HD = hexagon GABDEF - 2 tri. ABH

$$= \left[\text{trap. FLOE} = \frac{(FL + OE = FM = AB) \times (FE = AB)}{2} \right] \\ + \left[\text{trap. LABO} = \frac{(LA + BO = BA = AB) \times (AB)}{2} \right] = AB^2$$

= sq. on AB.

\therefore sq. upon AB = sq. upon HB + sq. upon HA.

$$\therefore h^2 = a^2 + b^2.$$

a. Type J, Case (1), (a). So its place is next after proof Two Hundred Nine, p. 218.

b. Proof and fig. devised by Joseph Zelson. Sent to me July 13, 1939.

Two Hundred Fifty-One

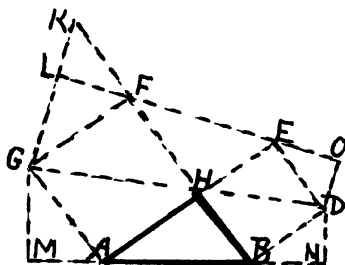


Fig. 363

Construct tri. KGF = tri. ABH; extend FE to L and O, the point at which a perp. from D intersects FE extended; also extend AB to M and N where perp's from G and D will intersect AB extended; draw GD.

By showing that:

tri. KLF = tri. DOE = tri. DNB; tri. FLG = tri. AMG; tri. KGF = tri. EFH = tri.

ABH; then it follows that: sq. GH + sq. HD = hexagon LGMNDO - 4 tri. ABH

$$= \left[\text{trap. LGDO} = \frac{(LG + DO = KG = AB) \times (FE = AB) + (2 \times \text{alt. FL})}{2} \right] \\ + \left[\text{trap. GMND} = \frac{(GM + ND = AB) \times (AB) + (2 \times \text{alt. } \{AM = FL\})}{2} \right] \\ - 4 \text{ tri. ABH} = \frac{2AB^2}{2} - 4 \text{ tri. ABH} = AB^2 - 4 \text{ tri. ABH.}$$

\therefore sq. upon AB = sq. upon HB + sq. upon HA.

$$\therefore h^2 = a^2 + b^2. \text{ Q.E.D.}$$

a. Type J. Case (1), (a). So its place is next after Proof Two Hundred Fifty-One.

b. This proof and fig. also devised by Master Joseph Zelson, a lad with a superior intellect. Sent to me July 13, 1939.

Two Hundred Fifty-Two

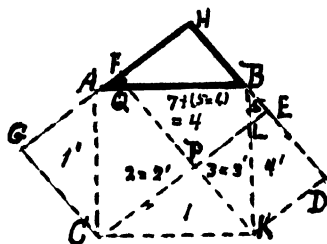


Fig. 364

By dissection, as per figure, and the numbering of corresponding parts by same numeral, it follows, through superposition of congruent parts (the most obvious proof) that the sum of the four parts (2 tri's and 2 quad'ls) in the sq. AK = the sum of the three parts (2 tri's and 1 quad.) in the sq. PG + the sum of the two parts (1 tri.

and 1 quad.) in the sq. PD.

That is the area of the sum of the parts 1+2 + 3 + 4 in sq. AK (on the hypotenuse AB) = the area of the sum of the parts 1' + 2' + 6 in the sq. PG (on the line GF = line AH) + the area of the sum of the parts 3' + 4' in the sq. PD (on the line PK = line HB), observing that part 4 + (6 = 5) = part 4'.

a. Type I, Case (6), (a). So its place belongs next after fig. 305, page 215.

b. This figure and proof was devised by the author on March 9, 1940, 7:30 p.m.

Two Hundred Fifty-Three

In "Mathematics for the Million," (1937), by Lancelot Hogben, F.R.S., from p. 63, was taken the following photostat. The exhibit is a proof which is credited to an early (before 500 B.C.) Chinese mathematician. See also David Eugene Smith's History of Mathematics, Vol. I, p. 30.

Mathematics in Prehistory

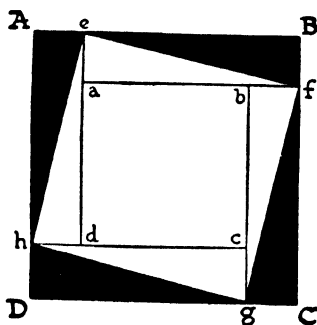
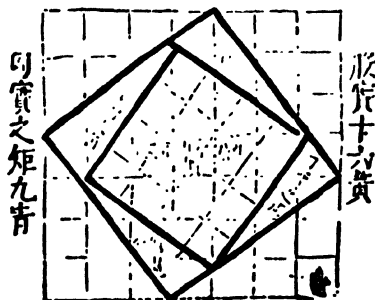


FIG. 19

The *Book of Chou Pei Suan King*, probably written about A. D. 40, is attributed by oral tradition to a source before the Greek geometer taught what we call the Theorem of Pythagoras, i.e. that the square on the longest side of a right-angled triangle is equivalent to the sum of the squares on the other two. This very early example of block printing from an ancient edition of the *Chou Pei*, as given in Smith's *History of Mathematics*, demonstrates the truth of the theorem. By joining to any right-angled triangle like the black figure eBf three other right-angled triangles just like it, a square can be formed. Next trace four oblongs (rectangles) like $eahB$, each of which is made up of two triangles like efB . When you have read Chapter 4 you will be able to put together the Chinese puzzle, which is much less puzzling than Euclid. These are the steps:

$$\begin{aligned} \text{Triangle } efB &= \frac{1}{2} \text{ rectangle } eahB = \frac{1}{2} Bf \cdot eB \\ \text{Square } ABCD &= \text{Square } efgh + 4 \text{ times triangle } efB \\ &= cf^2 + 2Bf \cdot eB \end{aligned}$$

$$\text{Also Square } ABCD = Bf^2 + eB^2 + 2Bf \cdot eB$$

$$\text{So } ef^2 + 2Bf \cdot eB = Bf^2 + eB^2 + 2Bf \cdot eB$$

$$\text{Hence } ef^2 = Bf^2 + eB^2$$

a. This believe-it-or-not "Chinese Proof" belongs after proof Ninety, p. 154, this book. (E.S.L., April 9, 1940).

Two Hundred Fifty-Four

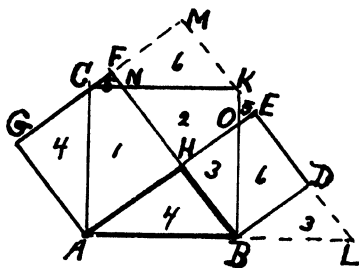


Fig. 365

= sq. HD) + ($\triangle OEK = \triangle NFC$) = $\square HD + \square HG$. Q.E.D. $\therefore h^2 = a^2 + b^2$.

a. This fig. and demonstration was formulated by Fred. W. Martin, a pupil in the Central Junior-Senior High School at South Bend, Indiana, May 27, 1940.

b. It should appear in this book at the end of the B-Type section, Proof Ninety-Two.

Two Hundred Fifty-Five

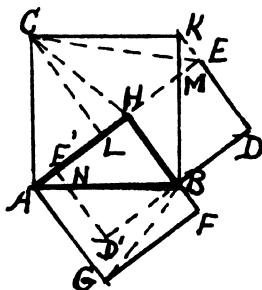


Fig. 366

Draw CL perp. to AH, join CH and CE; also GB. Construct sq. HD' = sq. HD. Then observe that $\triangle CAH = \triangle BAG$, $\triangle CHE = \triangle ABH$, $\triangle CEK = \triangle BFG$ and $\triangle MEK = \triangle NE'A$.

Then it follows that sq. AK = ($\triangle AHC = \triangle AGB$ in sq. HG) + ($\triangle HEC = \triangle BHA$ in sq. AK) + ($\triangle EKC = \triangle BFG$ in sq. HG) + ($\triangle BDK - \triangle MEK = \text{quad. BDEM}$ in sq. HD) + $\triangle HBM$ com. to sq.'s AK and HD = sq. HD + sq. HG. $\therefore h^2 = a^2 + b^2$.

a. This proof was discovered by Bob Chillag, a pupil

In the figure extend GF and DE to M, and AB and ED to L, and number the parts as appears in the quad. ALMG.

It is easily shown that: $\triangle ABH = \triangle ACG$, $\triangle BKN = \triangle KBL$ and $\triangle CNF = \triangle KOE$; whence $\square AK = (\triangle ABH = \triangle ACG$ in sq. HG) + quad. AHNC com. to \square 's AK and HG + ($\triangle BKN = \triangle KBL$) = ($\triangle BLD + \text{quad. BDEO}$

in the Central Junior-Senior High School, of South Bend, Indiana, in his teacher's (Wilson Thornton's) Geometry class, being the fourth proof I have received from pupils of that school. I received this proof on May 28, 1940.

b. These four proofs show high intellectual ability, and prove what boys and girls can do when permitted to think independently and logically.

E. S. Loomis.

c. This proof belongs in the book at the end of the E-Type section, One Hundred Twenty-Six.

Two Hundred Fifty-Six

Geometric proofs are either Euclidian, as the preceding 255, or Non-Euclidian which are either Lobachevskian (hypothesis, hyperbolic, and curvature, negative) or Riemannian (hypothesis, Elliptic, and curvature, positive).

The following non-euclidian proof is a literal transcription of the one given in "The Elements of Non-Euclidian Geometry," (1909), by Julian Lowell Coolidge, Ph.D., of Harvard University. It appears on pp. 55-57 of said work. It presumes a surface of constant negative curvature,--a pseudo sphere,--hence Lobachevskian; and its establishment at said pages was necessary as a "sufficient basis for trigonometry," whose figures must appear on such a surface.

The complete exhibit in said work reads:

"Let us not fail to notice that since $\sphericalangle ABC$ is a right angle we have, (Chap. III, Theorem 17),

$$\lim. \frac{BC}{AC} = \cos \left(\frac{\pi}{2} - \theta \right) = \sin \theta. \quad \text{--- (3)}$$

"The extension of these functions to angles whose measures are greater than $\frac{\pi}{2}$ will afford no difficulty, for, on the one hand, the defining series remains convergent, and, on the other, the geometric extension may be effected as in the elementary books.

"Our next task is a most serious and fundamental one, to find the relations which connect the measures and sides and angles of a right triangle. Let this be the $\triangle ABC$ with $\sphericalangle ABC$ as the right angle. Let the measure of $\sphericalangle BAC$ be ψ while that of $\sphericalangle BCA$ is θ .

We shall assume that both ψ and θ are less than $\frac{\pi}{2}$, an obvious necessity under the euclidian or hyperbolic hypothesis, while under the elliptic, such will still be the case if the sides of the triangle be not large, and the case where the inequalities do not hold may be easily treated from the case where they do. Let us also call a , b , c the measures of \overline{BC} , \overline{CA} , \overline{AB} respectively.

"We now make rather an elaborate construction. Take B_1 in (AB) as near to B as desired, and A_1 on

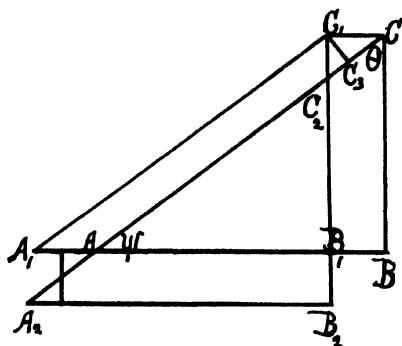


Fig. 2

the extension of (AB) beyond A , so that $\overline{AA_1} \equiv \overline{BB_1}$ and construct

$\triangle A_1B_1C_1 \equiv \triangle ABC$, C_1 lying not far from C ; a construction which, by 1 (Chap. IV, Theorem 1), is easily possible if $\overline{BB_1}$ be small enough. Let $\overline{B_1C_1}$ meet (AC) at C_2 .

$\angle C_1C_2C$ will differ but little from $\angle BCA$, and we may draw $\overline{C_1C_3}$ perpendicular to $\overline{CC_2}$, where C_3 is a point of (CC_2) . Let

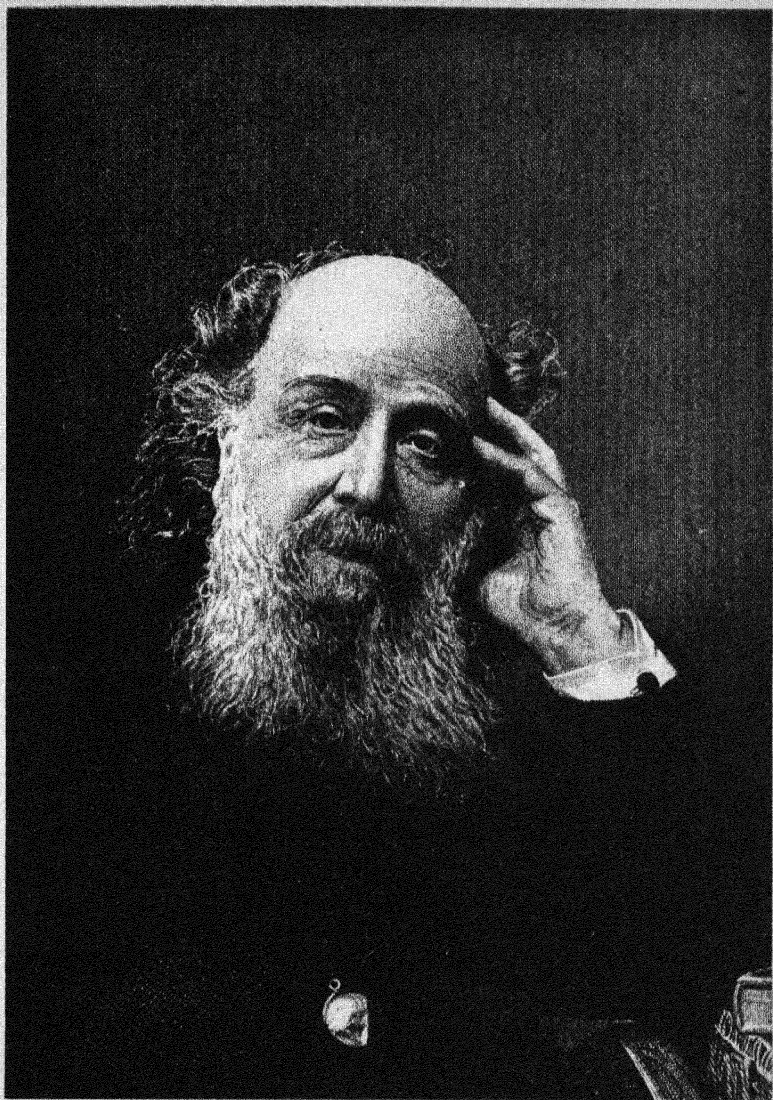
us next find A_2 on the

extension of (AC) beyond A so that $\overline{A_2A} \equiv \overline{C_2C}$ and B_2 on the extension of (C_1B_1) beyond B_1 so that $\overline{B_1B_2} \equiv \overline{C_1C_2}$, which is certainly possible as $\overline{C_1C_2}$ is very small. Draw $\overline{A_2B_2}$. We saw that $\angle C_1C_2C$ will differ from $\angle BCA$ by an infinitesimal (as B_1B decreases) and $\angle CC_1B_1$ will approach a right angle as a limit. We thus get two approximate expressions of $\sin \theta$ whose comparison yields $\frac{\overline{C_1C_3}}{\overline{C_1C_2}} = \frac{\overline{CC_1}}{\overline{CC_2}} + \epsilon_1 = \frac{\cos a/k \overline{BB_1}}{\overline{CC_2}} + \epsilon_2$,

for $\overline{CC_1} - \cos a/k \overline{BB_1}$ is infinitesimal in comparison to $\overline{BB_1}$ or $\overline{CC_1}$. Again, we see that a line through the middle point of (AA_1) perpendicular to AA_2 will also be perpendicular to A_1C_1 , and the distance of the intersections will differ infinitesimally from $\sin \psi \overline{AA_1}$. We see that $\overline{C_1C_2}$ differs by a higher infinitesimal

from $\sin \psi \cos b/k \overline{AA_1}$, so that $\cos \frac{b}{k} \sin \psi \frac{\overline{AA_1}}{\overline{C_1C_2}} + \epsilon_3 = \frac{\cos a/k \overline{BB_1}}{\overline{CC_1}} + \epsilon_2$.

"Next we see that $\overline{AA_1} \equiv \overline{BB_1}$, and hence $\cos \frac{b}{k} = \frac{1}{\sin \psi} \cos a/k \cdot \frac{\overline{C_1C_2}}{\overline{CC_2}} + \epsilon_4$. Moreover, by



JAMES JOSEPH SYLVESTER

1814-1897

construction $\overline{C_1C_2} \equiv \overline{B_1B_2}$, $\overline{CC_2} \equiv \overline{AA_2}$. A perpendicular to $\overline{AA_1}$ from the middle point of (AA_2) will be perpendicular to $\overline{A_2B_2}$, and the distance of the intersections will differ infinitesimally from each of these expressions $\sin \psi \overline{AA_2}$, $\frac{1}{\cos c/k} \overline{B_1B_2}$. Hence

$$\cos \frac{b}{k} - \cos \frac{a}{k} \cos \frac{c}{k} < \epsilon. \quad \cos \frac{b}{k} = \cos \frac{a}{k} \cos \frac{c}{k}. \quad \text{--- (4)}$$

"To get the special formula for the euclidian case, we should develop all cosines in power series, multiply through by k^2 , and then put $1/k^2 = 0$, getting $b^2 = a^2 + c^2$, the usual Pythagorean formula."

a. This transcription was taken April 12, 1940, by E. S. Loomis.

b. This proof should come after c, p. 244.

- - - - -

This famous Theorem, in Mathematical Literature, has been called:

1. The Carpenter's Theorem
2. The Hecatomb Proposition
3. The Pons Asinorum
4. The Pythagorean Proposition
5. The 47th Proposition

Only four kinds of proofs are possible:

1. Algebraic
2. Geometric--Euclidian or non-Euclidian
3. Quaternionic
4. Dynamic

In my investigations I found the following Collections of Proofs:

	No.	Year
1. The American Mathematical Monthly	100	1894-1901
2. The Colburn Collection	108	1910
3. The Edwards Collection	40	1895
4. The Fourrey Collection	38	1778
5. The Heath Monograph Collection	26	1900
6. The Hoffmann Collection	32	1821
7. The Richardson Collection	40	1858
8. The Versluys Collection	96	1914
9. The Wipper Collection	46	1880
10. The Cramer Collection	93	1837
11. The Runkle Collection	28	1858

SOME NOTED PROOFS

Of the 370 demonstrations, for:

	Proof
1. The shortest, see p. 24, Legendre's.....	One
2. The longest, see p. 81, Davies Legendre ..	Ninety
3. The most popular, p. 109,	Sixteen
4. Arabic, see p. 121; under proof	Thirty-Three
5. Bhaskara, the Hindu, p. 50,	Thirty-Six
6. The blind girl, Coolidge, p. 118,	Thirty-Two
7. The Chinese--before 500 B.C., p. 261,	Two Hundred Fifty-Three
8. Ann Condit, at age 16, p. 140 (Unique)	Sixty-Eight
9. Euclid's, p. 119,	Thirty-Three
10. Garfield's (Ex-Pres.), p. 231,	Two Hundred Thirty-One
11. Huygens' (b. 1629), p. 118,	Thirty-One
12. Jashemski's (age 18), p. 230,	Two Hundred Thirty
13. Law of Dissection, p. 105,	Ten
14. Leibniz's (b. 1646), p. 59,	Fifty-Three
15. Non-Euclidian, p. 265, ...	Two Hundred Fifty-Six
16. Pentagon, pp. 92 and 238,	One Hundred Seven and Two Hundred Forty-Two
17. Reductio ad Absurdum, pp. 41 and 48,	Sixteen and Thirty-Two
18. Theory of Limits, p. 86,	Ninety-Eight

They came to me from everywhere.

1. In 1927, at the date of the printing of the 1st edition, it shows--No. of Proofs:
Algebraic, 58; Geometric, 167; Quaternionic, 4; Dynamic, 1; in all 230 different proofs.
2. On November 16, 1933, my manuscript for a second edition gave:
Algebraic, 101; Geometric, 211; Quaternionic, 4; Dynamic, 2; in all 318 different proofs.
3. On May 1, 1940 at the revised completion of the manuscript for my 2nd edition of The Pythagorean Proposition, it contains--proofs:
Algebraic, 109; Geometric, 255; Quaternionic, 4; Dynamic, 2; in all 370 different proofs, each proof calling for its own specific figure. And the end is not ye⁺.

E. S. Loomis, Ph.D.
at age nearly 88,
May 1, 1940

BIBLIOGRAPHY

The sources, from which historical facts, suggestions, illustrations, demonstrations and other data concerning the preparation of this book, or for further investigation by any one who may wish to compare and consider original sources, are comprised in the following tabulation.

I. TEXTS ON GEOMETRY

1. Beman and Smith's Plane and Solid Geometry, 1895.
2. Bezout's Elements of Geometry, 1768.
3. Camerer, J. G. et C. F. Hanbes-Berel, 1824.
4. Chauvenet's Elements of Geometry, 1887.
5. Cramer, (C.), 1837, 93 proofs.
6. Davies' Legendre, 1858.
7. Dobriner's (Dr. H.) Geometry.
8. Edwards' Geometry, 1895.
9. Halsted's Elementary Geometry, 1895.
10. Hill's Geometry for Beginners, 1886.
11. Hopkins' Plane Geometry, 1891.
12. Kunze's (van) Geometry, 1842.
13. Mackay's (J. S.) Plane Geometry.
14. Mahler's (G.) "Ebene Geometrie," 1897.
15. Milne's Plane and Solid Geometry, 1899.
16. Olney's Elements of Geometry, 1872, Univ'y Ed'n.
17. Pisano (Leonardo) Practica Geometriae.
18. Ray's Geometry.
19. Richards' (Claudius) "Euclides Elementorum Geometricorum," 1645, Antwerpiae.
20. Sauvens' (M.) Geometry, 1753.
21. Schuyler's (Dr. A.) Elements of Geometry, 1876.
22. Simpson's (Thos.) Elementary Geometry.
23. Todhunter's Elements of Euclid, 1897.
24. Wells' Essentials of Geometry, 1899.
25. Wentworth and Smith's Plane Geometry, Revised Edition, 1910.
26. Wentworth's New Plane and Solid Geometry, 1895.

II. OTHER TEXTS

1. Bernstein, (F.) The Axiomatic Simplicity of Proofs, 1909.
2. Blanchard's (Orlando) Arithmetic.
3. Brandes' Dissection Proofs, 1908.
4. Casey's Sequel to Euclid, Part I, 1900.
5. Cours de Mathematiques, 1768.
6. Cullen's (P. C.) Pamphlet.
7. Delboeuf's work.
8. Fourrey's (E.) Curiosities Geometriques, 2nd Ed'n, 430 pages, 1778, Paris.
9. Geometric Exercises, Paper Folding, 1905.
10. Halsted's Mensuration.
11. Handbook der Mathematik, 1869.
12. Hardy's Elements of Quaternions, 1881.
13. Hubert's Rudimenta Algebrae, 1792.
14. Leitzmann's (Dr. W.) "Des Pythagorische Lehrsatz," 1930.
15. Littrow's (E. von) "Popular Geometrie," 1839.
16. Loomis (Dr. E. S.), The Pythagorean Proposition.
17. Row's Geometric Exercises in Paper Folding, 1905.
18. Schubert's Mathematical Essays, 1898.
19. Schuyler's (Dr. A.), Trigonometry, 1873.
20. Simon (M.), 1906.
21. Vogt (H.), The Geometry of Pythagoras, Vol. 3, 1909.
22. Wallis' Treatise of Algebra, 1685.

III. MONOGRAPHS

1. Heath's Mathematical Monographs, Nos. 1 and 2, 1900.
2. Hoffmann's (J. J. I.), The Pythagorean Theorem, 1821--32 Proofs.
3. Martin's (Artemus), "On Rational Right-Angled Triangles (Pamphlet), 1912.
4. Mathematical Monograph, No. 16, 1915, Diaphontine Analysis des Pythagoraische Lehrsatz, by Leitzmann.

5. Naber (Dr. H. A.), Das Theorem des Pythagoras, 1908.
6. Versluys' (J.), Theorem van Pythagoras, Zes en Negentig Bewijzen, 1914, 96 Proofs.
7. "Vriend de Wiskunde," 1898 by Vaes (F. J.).
8. Wipper, (Jury), "46 Beweise des Pythagoraischen Lehrsates," 1880, 46 Proofs.

IV. JOURNALS AND MAGAZINES

1. American Mathematical Monthly, 1894-1901, Vols. I to VIII inclusive, 100 proofs. The Editor, Dr. B. F. Yanney said: "There is no limit to the number of proofs--we just had to quit."
2. Archiv der Mathematik and Phys., Vols. II, XVII, XX, XXIV, 1855, by Ph. Grunert, 1857.
3. Aumerkungen uber Hr. geh. R. Wolf's Ausgug aus der Geometrie," 1746, by Kruger.
4. Bernstein (F.), The Pythagorean Theorem, 1924.
5. Companion to Elementary School Mathematics, 1924.
6. Heutton's (Dr.), Tracts--History of Algebra, 3 Vols., 1912.
7. Journal of Education, 1885-8, Vols. XXV, XXVI, XXVII, XXVIII.
8. Journal de Mathein, 1888, by F. Fabre.
9. Journal of the Royal Society of Canada, 1904, Vol. II, p. 239.
10. Lehrbegriff's Science of Mathematik.
11. Masonic Bulletin, Grand Lodge of Iowa, No. 2, February 1929.
12. Mathematical Essays and Recreations.
13. Mathematical Magazine, The, Vols. I and II, by Martin, 1891.
14. Mathematical Monthly, Vols. I and II, 1858, 28 Proofs, by J. D. Runkle.
15. Mathematics Teacher, Vol. XVI, 1915, Vol. XVIII, 1925.
16. Messenger of Mathematics, Vol. 2, 1873.
17. Nengebrauer's (O.), History of the Pythagorean Theorem, 1928.

18. Notes and Queries, by W. D. Henkle, 1875-81.
19. Nouvelles Annales, Vol. LXII.
20. Open Court Pub. Co., 1898, p. 39--Magic Squares.
21. Periodico di Mathematicke (Italian), History of the Pythagorean Theorem.
22. Philosophia et Mathesis Universa.
23. Philosophical Transactions, 1683.
24. Pythagorean Theorem, The, by Cullen.
25. Quarterly Journal of Mathematics, Vol. I.
26. Recreations in Mathematics and Physics, 1778.
27. Runkle's Mathematical Monthly, No. 11, 1859.
28. School Visitor, The, Vol. III, 1882, Vol. IX, 1888.
29. Schörrer's The Theorem of Pythagoras, 1929.
30. Science, New Series, Vol. 32, 1910; Vol. 33, 1911; Vol. 34, 1912.
31. Scientia Baccalurem.
32. The Scientific American Supplement, Vol. 70, 1910, pp. 359, 382-3.
33. Scientifique Revue, 1859.

V. GENERAL REFERENCE WORKS

1. Ball's Short History of Mathematics, 1888.
2. The Encyclopedia Britannica--articles on Geometry, Magic Squares, Dynamics, Quaternions or Vector Analysis, Euclid, Pythagoras, etc.
3. Encyclopadie, des Elementar Mathematick, 1923, by H. Weber and J. Wellstein.
4. Scanscrit Mathematics.
 - (1) "Viga Ganita."
 - (2) "Yoncti Bacha."
5. Wolf's (Dr. Rudolph), Handbook of Mathematics, 1869
6. Müller (J. W.), Nürnberg, 1819.

VI.

The Royal Society of London--Index 1800-1900; Vol. I, Pure Mathematics, 1908, lists the following authors and articles:

1. *Muller, H. K. F. von*: Oken Isis (1826), 763ff.
2. *Gundermann, C.*: Crelle, J. 42 (1852), 280ff.
3. *Vincent, A. J. N.*: N. A. Mth. 11 (1852), 5ff.
4. *DeMorgan, A.*: Q. J. Mth. 1 (1857), 236ff.
5. *Salwen, G.*: Q. J. Mth. 1 (1857), 237ff.
6. *Richardson, J. M.*: Camb. (M.) Math. M. 2 (1860), 45ff.
7. *Azzarelli, M.* 1873 : Rm. N. Linc. At. 27 (1874), 66ff.
8. *Harvey, W.*: Edinb. Math. S. P. 4 (1886), 17ff.
9. *Zahradnik, K.*: Casopis 25 (1896), 261ff. Schr. Mth. (1896), 364ff.
10. Confirmation. *Wittstein, T.*: Grunert Arch. 11 (1848), 152.
11. Pythag. triangle. *Grunert, J. A.*: Arch. der. Mth. and Physik 31 (1858), 472ff.
12. Demonstration. *Boquoy, G. von*: Oken Isis 21 (1828), 1ff.
13. ----- by dissection. *Perigal, H.*: Mess. Mth. 2 (1873), 103ff.
14. Extension to any triangle. *Jelinek, V.*: Casopis 28 (1899), 79ff.. F. Schr. Mth. (1899), 456.
15. Extensions. *Anglin, A. H.*: Edinb. R. S. P. 12 (1884) 703.
16. Figures for proving. *Andre, H. d'*: N. A. Mth. 5 (1846), 324.
17. Generalization. *Umpfenbach (Dr.)*: Crelle J. 26 (1843), 92.
18. Puzzles connected with theorem. *Brand, E.*: Rv. Sc. 2 (1894), 274ff., 809ff.
19. Pythagorean triangles. *Cantor, M.*: Schlonzilch, Z. 4 (1859), 306ff.
20. Pythagorean triangles. *Lewis, J.*: Am. Ph. S. P. 9 (1865), 415ff.
21. Pythagorean triangles. *Whitworth, W. A.*: Lpool, Ph. S. P. 29 (1875), 237ff.

22. Pythagorean triangles and applications to the division of the circumference. *Grueber*: Arch. Mth. und Physik 15 (1897), 337ff.
23. Pythagorean triangle, nearly isosceles. *Martin*, Art: Des Moines Anal 3 (1876), 47ff.
24. Pythagorean triangle, properties. *Breton*: Ph. Les Mondes 6 (1864), 401ff.
25. Right-angled triangles. *Bangma*, V. S.: Amst. Vh. 4 (1818), 28ff.
26. Right-angled triangles, squares on sides (Hamett). *Gergonne*, J. D.: Gergonne A. Mth. 14 (1823), 334ff.
27. Quadrangles, complete. *Newberg*, J.: Mathses 11 (1891), 33ff, 67ff, 81ff, 189ff.
28. Quadrangles, transformations. *Gob*, A.: As. Fr. C. R. (1884), (Pt. 2), 294ff.

TESTIMONIALS

From letters of appreciation and printed Reviews the following four testify as to its worth.

New Books. The Mathematics Teacher, 1928, has: The Pythagorean Theorem, Elisha S. Loomis, 1927, Cleveland, Ohio, 214 pp. Price \$2.00.

"One hundred sixty-seven geometric proofs and fifty-eight algebraic proofs besides several other kinds of proofs for the Pythagorean Theorem compiled in detailed, authoritative, well-organized form will be a rare 'find' for Geometry teachers who are alive to the possibilities of their subject and for mathematics clubs that are looking for interesting material. Dr. Loomis has done a scholarly piece of work in collecting and arranging in such convenient form this great number of proofs of our historic theorem.

"The book however is more than a mere cataloging of proofs, valuable as that may be, but presents an organized suggestion for many more original proofs. The object of the treatise is twofold, 'to present to the future investigator, under one cover, simply and concisely, what is known relative to the Pythagorean proposition, and to set forth certain established facts concerning the proofs and geometric figures pertaining thereto.'

"There are four kinds of proofs, (1) those based upon linear relations--the algebraic proof, (2) those based upon comparison of areas--the geometric proofs, (3) those based upon vector operations --the quaternionic proofs, (4) those based upon mass and velocity--the dynamic proofs. Dr. Loomis contends that the number of algebraic and geometric proofs are each limitless, but that no proof by trigonometry, analytics or calculus is possible due to

the fact that these subjects are based upon the right-triangle proposition.

"This book is a treasure chest for any mathematics teacher. The twenty-seven years which Dr. Loomis has played with this theorem is one of his hobbies, while he was Head of the Mathematics Department of West High School, Cleveland, Ohio, have been well spent since he has gleaned such treasures from the archives. It is impossible in a short review to do justice to this splendid bit of research work so unselfishly done for the love of mathematics. This book should be highly prized by every mathematics teacher and should find a prominent place in every school and public library."

H. C. Christoffenson

Teachers College
Columbia University, N.Y. City

- - - - -

From another review this appears:

"It (this work) presents all that the literature of 2400 years gives relative to the historically renowned and mathematically fundamental Pythagorean proposition--the proposition on which rests the sciences of civil engineering, navigation and astronomy, and to which Dr. Einstein conformed in formulating and positing his general theory of relativity in 1915.

"It establishes that but four kinds of proofs are possible--the Algebraic, the Geometric the Quaternionic and the Dynamic.

"It shows that the number of Algebraic proofs is limitless.

"It depicts 58 algebraic and 167 geometric proofs.

"It declares that no trigonometric, analytic geometry, or calculus proof is possible.

"It contains 250 geometric figures for each of which a demonstration is given.

"It contains a complete bibliography of all references to this celebrated theorem.

"And lastly this work of Dr. Loomis is so complete in its mathematical survey and analysis that it is destined to become the reference book of all future investigators, and to this end its sponsors are sending a complimentary copy to each of the great mathematical libraries of the United States and Europe."

Masters and Wardens Association
of the
22nd Masonic District of Ohio

- - - - -

Dr. Oscar Lee Dustheimer, Prof. of Mathematics and Astronomy in Baldwin-Wallace College, Berea, Ohio, under date of December 17, 1927, wrote: "Dr. Loomis, I consider this book a real contribution to Mathematical Literature and one that you can be justly proud of....I am more than pleased with the book."

Oscar L. Dustheimer

- - - - -

Dr. H. A. Naber, of Baarn, Holland, in a weekly paper for secondary instructors, printed, 1934, in Holland Dutch, has (as translated): "The Pythagorean Proposition, by Elisha S. Loomis, Professor Emeritus of Mathematics, Baldwin-Wallace College," (Bera, O.).....

Dr. Naber states...."The author has classified his (237) proofs in groups: algebraic, geometric, quaternionic and dynamic proofs; and these groups are further subdivided." "...Prof. Loomis himself has wrought, in his book, a work that is more durable than bronze and that tower higher even than the pyramids." "...Let us hope--until we know more completely--that by this procedure, as our mentality grows deeper, it will become as in him: The Philo-sophic Insight."

INDEX OF NAMES

1. Names of all authors of works referred to or consulted in the preparation of this book may be found in the bibliography on pp. 271-76.
2. Names of Texts, Journals, Magazines and other publications consulted or referred to also appear in said bibliography.
3. Names of persons for whom a proof has been named, or to whom a proof has been credited, or from or through whom a proof has come, as well as authors of works consulted, are arranged alphabetically in this Index of personal names.
4. Some names occur two or more times, but the earliest occurrence is the only one paged.

- Adams, J., 60
Agassiz, 190
Amasis, 8
Anaksimander, 8
Andre, H. d', 98
Anglin, A. H., 275
Andronicus, 15
Annairizo of Arabia,
 900 N.C., 51
Arabic proof, 121
Ash, M. v. (1683), 150
Azzarelli, M., 275
- Ball, W. W. Rouse, 154
Bangma, V. S., 276
Bauer, L. A., 79
Bell, E. T. (Dr.), vi
Bell, Richard A., 49
Bernstein, F., 272
Bhaskara, the Hindu, 50
Binford, R. E., 230
Blanchard, Orlando, 155
Boad, Henry, 1733, 137
- Boon, F. C., 66
Boquoy, G. von, 275
Botcher, J. E., 112
Brand, E., 65
Brandes, 272
Bressert, M. Piton, 67
Breton, 276
Bretschenschneider, 155
Brown, Lucius, 79
Buck, Jenny de, 149
Bullard, L. J., 83
- Calderhead, Prof. James A.,
 247
Camerer, 13
Camirs, Jules, 52
Cantor, M., 5
Carmichael, Robert D., 24
Casey, 253
Cass, Gustav, 226
Cattell, J. McK., 249
Chase, Pliny Earle, 109
Chauvenet, 52

- Chillag, Bob, 263
 Chinese proof, 262
 Christofferson, H. C., 278
 Clairaut, 1741, 203
 Colburn, Arthur E., 53
 Collins, Matthew, 18
 Condit, Ann (age 16), 140
 Coolidge, Miss E. A.
 (blind girl), 119
 Coolidge, Julian Lowell, 265
 Copernicus, 12
 Cramer, C., 271
 Crelle, J., 275
 Cullen, R. C., 155

 Darwin, 121a
 Davies (Legendre), 24
 DeBeck, Bodo M., 227
 Deimal, R. F., 250
 Delboeuf, 134
 DeMorgan, A., 105
 Descartes, 244
 Dickinson, M., 179
 Dickson, Leonard E., 17
 Diogenes, 6
 Dissection, Law of--Loomis, 106
 Dobriner, Dr. H., 111
 Dulfer, A. E. B., 57
 Dustheimer, Dr. Oscar L., 279

 Edison, 12
 Edwards, 25
 England, W., 120
 Epstein, Paul, 115
 Eratokles, 9
 Euclid, 13
 Evans, Geo. W., 57
 Excell, Rev. J. G., 49

 Fabre, F., 57

 Ferekid, 9
 Forbes, E., 203
 Foureay, E., 49
 French, C., 133

 Galileo, 12
 Garfield, Pres. James A., 224
 Gauss, 16
 Gelder, Jacob de, 121
 Gergonne, J. D., 276
 Ginsburg, Dr. Jehuthiel, xiv
 Glashier, J. W. L., 17
 Gob, A., 276
 Graap, F., 11
 Grueber, 276
 Grundermann, C., 275
 Grunert, J. A., 53
 Gutheil, B. von--World War
 Proof, 117

 Halsted, Geo. B., 21
 Hamlet, 120
 Hardy, 272
 Harvey, W., 275
 Hauff, von, 123
 Hawkins, Cecil, 57
 Haynes, 226
 Heath, 24
 Henkle, W. D., 274
 Hersey, Mayo D., 249
 Hill, 271
 Hippias, 9
 Hoffmann, Joh. J. I., 1818,
 29
 Hogben, Lancelot, 261
 Hoover, Wm., 155
 Hopkins, G. I., 68
 Horace, 285
 Houston, Joseph, 145
 Hoyt, David W., 109

- Hubertl, 1762, 225
Hutton, Dr., 48
Huygens, 1657, 118
Hypasos, 11
Hypsiclem, 157
- Ingraham, Andrew, 243
Isidorum, 156
- Jackson, C. S., 226
Jashemski, Stanley, 84
Jelinek, v., 232
Jengis, Khan, 155
Joan, R., 177
Johnston, Theodore H., xiii
Jowett, 86
- Kambis, 9
Kemper, C. J., 70
Khayyam, Omar, 120a
Klagel, 151
Knöer, Alvin, 40
Kröger, M., 110
Krueger, 1746, 1
Kruitbosch, D. J., 139
Kunze, von, 192
- Laertius, 6
Laisnez, Maurice, 50
Lamy, R. P., 1685, 85
Lecchio, 125
Legendre, Andren M., 24
Lehman, Prof. D. A., 40
Leibniz, von, 59
Leonardo da Vinci, 129
Lewis, J., 275
Leitzmann, Dr. Wm., 49
Littrow, E. von, 113
Locke, J. B., 248
Loomis, Elatus G., xiv
Loomis, Dr. E. S., 158
- Macay, 271
MacFarlane, Alexander, 249
Mahler, von G., 105
Marconi, 12
Marre, A., 50
Martin, Artemas, 17
Martin, Fred W., 263
Masares, 20
McCready, J. M., 174
McIntosh, M., 209
Meyer, P. Armand, 44
Milne, 271
Mnessarch, 7
Möllman, E., 79
Müller, J. W., 274
- Naber, Dr. H. A., 273
Nasir-Ed-Din, Persian Astronomer, 128
Nengebrauer, 273
Newberg, J., 276
Newton, Sir Isaac, 12
Nielson, Chr., 114
Northrup, Edwin F., 249
- Oliver, 83
Olney, 73
Ozanam, M. de C. G., 1778, 110
- Pappus, a. 375 A.D., 126
Perigal, Henry, 102
Philippi, III of Spain, 156
Phillips, Dr. Geo. M., 183
Pisano, Leonardo, 52
Pithay, 7
Piton-Bressant, 67
Plato, 17
Plutarch, 6
Polycrates, 7

- Posthumus, J. J., 92
Proclos, 4
Psammit, 9
Ptolemus (Ptolemy), 66
Pythagoras, 6
- Raub, M., 66
Ray, Prof. Saradarujan (India), 155
Reichenberger, Nepomucen, 177
Renan, H., 46
Richards, Claudius, 156
Richardson, Prof. John M., 26
Rogot, M., 180
Row, T. Sundra, 100
Runkle, J. D., 66
Rupert, Wm. W., 23
- Salwen, G., 275
Sarvonarola, 12
Saunderson, 229
Sauveur, 227
Schau-Gao, 5
Schlömilch, 194
Schooten, van, 203
Schörer, 274
Schubert, Herman, 256
Schuyler, Dr. Aaron, 64
Simon, 272
Simpson, David P., xiii
Simpson, Thomas, 155
Skatschkow, 5
Smedley, Fred S., 90
Smith, David E., 271
Smith, Dr. Wm. B., 155
Socrates, 86
Sonchis, 9
Sterkenberg, C. G., 40
Stowell, T. P., 224
Sturm, J. C., 203
Sunderland, 158
- Tarquin, 9
Templehoff, von, 1769, 129
Thales, 8
Theana, 10
Thompson, J. G., 234
Thornton, Wilson, 50
Todhunter, Dr., 271
Towne, Paul W., 255
Trowbridge, David, 152
Tschou-Gun, 5
Tyron, C. W., 110
- Umpfenbach, Dr., 275
Uwan, 5
- Vaes, F. J., 46
Versluys, J., 13
Vieth, van, 132
Vincent, A. J. N., 275
Vinci, Leonardo da, 129
Vogt, H., 272
Vuibert, Jal de, 47
- Wallis, John, 52
Warius, Peter, 148
Waterhouse, John, 252
Weber, H., 40
Wells, 271
Wellstein, T., 40
Wentworth, 52
Werner, Oscar, 53
Wheeler, Rev. D. A., 49
Whitworth, 275
Wipper, Jury, 3
Wolf, Rudolph, 274
- Yanney, Prof. B. F., 242
Young, Dr. Charles A., 70
- Zahradnik, 275
Zelson, Joseph, 122
Zelson, Prof. Louis G., 141

*"Exegi monumentum, aere perennius
Regali que situ pyramidum altius,
Quod non imber edax, non aquilo impotens
Possit diruere aut innumerabilis
Annorum series et fuga temporum.
Non omnis moriar."*

*--Horace
30 ode in
Book III*

